



# 3V to 5V Regulating Charge Pumps for SIM Cards

MAX1686/MAX1686H

## General Description

The MAX1686 provides power for dual-voltage subscriber ID module (SIM) cards in portable applications such as GSM cellular phones. Designed to reside in the portable unit (cellular phone handset), the 1MHz charge pump converts a 2.7V to 4.2V input to regulated 5V output. The MAX1686H has a nominal output voltage of 5.0V, while the MAX1686 is set to 4.75V to reduce SIM-card current drain. The charge pump has only 45µA quiescent supply current, which reduces to 3µA when a 3V-capable SIM card is being powered and the charge pump is disabled. An internal input/output shorting switch provides power for 3V SIM cards.

The MAX1686/MAX1686H require only three external capacitors around their space-saving, thin (1mm) 8-pin µMAX packages.

## Applications

- GSM Cellular Phones
- PCS Phones
- Portable POS Terminals
- Personal Communicators

## Features

- ◆ 2.7V to 4.2V Input Range
- ◆ 12mA min Charge-Pump Output Current
- ◆ 45µA Quiescent Supply Current
- ◆ 0.1µA Supply Current in Shutdown Mode
- ◆ 5.0V Regulated Charge-Pump Output (MAX1686H)  
4.75V Regulated Charge-Pump Output (MAX1686)
- ◆ Input-Output Shorting Switch for 3V Cards
- ◆ Small External Components  
(Uses a 0.047µF, 0.1µF, and a 2.2µF Capacitor)
- ◆ Output Driven to Ground in Shutdown Mode
- ◆ Super-Small 8-Pin µMAX Package
- ◆ Soft-Start and Short-Circuit Protection

## Ordering Information

PART	TEMP. RANGE	PIN-PACKAGE
MAX1686EUA	-40°C to +85°C	8 µMAX
MAX1686HEUA	-40°C to +85°C	8 µMAX

## Typical Operating Circuit

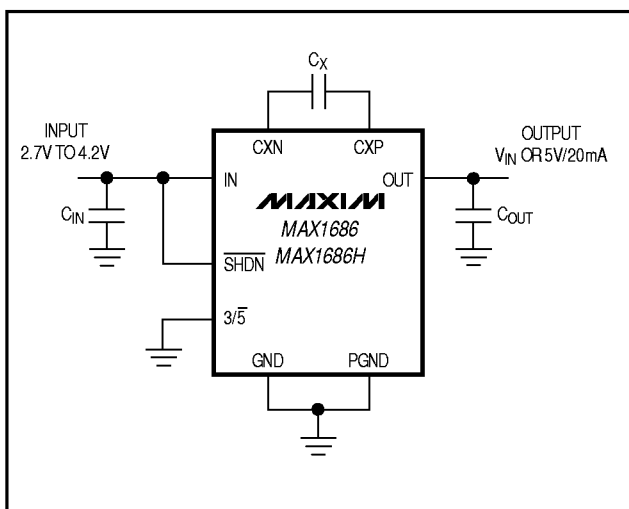

## Pin Configuration

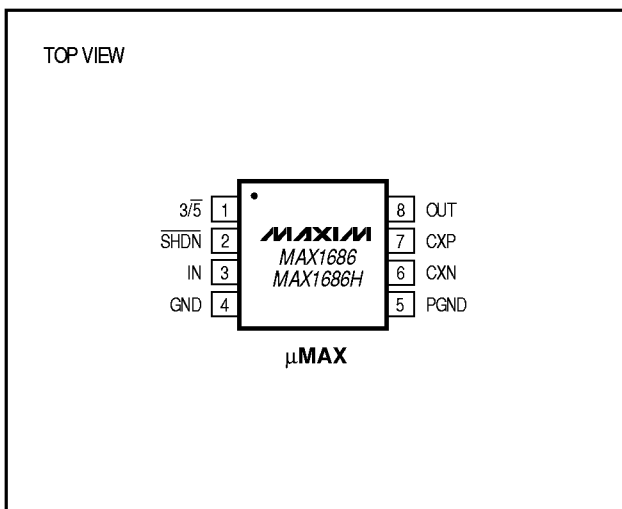

# 3V to 5V Regulating Charge Pumps for SIM Cards

## ABSOLUTE MAXIMUM RATINGS

IN, OUT,  $\overline{\text{SHDN}}$ ,  $3/\overline{5}$  to GND.....-0.3V to +6V  
 CXP to GND.....-0.3V to ( $V_{\text{OUT}} + 0.3\text{V}$ )  
 CXN to GND .....-0.3V to ( $V_{\text{IN}} + 0.3\text{V}$ )  
 PGND to GND .....-0.3V to + 0.3V  
 OUT Short Circuit to GND .....Continuous  
 IN-to-OUT Current.....50mA

Continuous Power Dissipation ( $T_A = +70^\circ\text{C}$ )  
 8-Pin  $\mu\text{MAX}$  (derate 4.1mW/ $^\circ\text{C}$  above  $+70^\circ\text{C}$ ) .....330mW  
 Operating Temperature Range  
 MAX1686EUA/MAX1686HEUA.....-40 $^\circ\text{C}$  to +85 $^\circ\text{C}$   
 Junction Temperature .....+150 $^\circ\text{C}$   
 Storage Temperature Range .....-65 $^\circ\text{C}$  to +165 $^\circ\text{C}$   
 Lead Temperature (soldering, 10sec) .....+300 $^\circ\text{C}$

Stresses beyond those listed under "Absolute Maximum Ratings" may cause permanent damage to the device. These are stress ratings only, and functional operation of the device at these or any other conditions beyond those indicated in the operational sections of the specifications is not implied. Exposure to absolute maximum rating conditions for extended periods may affect device reliability.

## ELECTRICAL CHARACTERISTICS

( $V_{\text{IN}} = V_{\overline{\text{SHDN}}} = 3.3\text{V}$ ,  $3/\overline{5} = \text{GND}$ ,  $C_X = 0.22\mu\text{F}$ ,  $C_{\text{OUT}} = 10\mu\text{F}$  (see *Applications Information* section to use smaller capacitors),  $T_A = T_{\text{MIN}}$  to  $T_{\text{MAX}}$ , unless otherwise noted. Typical values are at  $T_A = +25^\circ\text{C}$ .) (Note 1)

PARAMETER	CONDITIONS		MIN	TYP	MAX	UNITS
Input Voltage Range			2.7		4.2	V
Input Undervoltage-Lockout Threshold Voltage			0.8	1.2	1.6	V
Quiescent Supply Current	Charge pump enabled, no load, $3/\overline{5} = \text{GND}$	$T_A = +25^\circ\text{C}$		45	100	$\mu\text{A}$
		$T_A = -40^\circ\text{C}$ to $+85^\circ\text{C}$			150	
	Charge pump disabled, no load, $3/\overline{5} = \text{IN}$			3	10	
Shutdown Supply Current	$V_{\text{IN}} = 3.6\text{V}$ , $\overline{\text{SHDN}} = \text{GND}$			0.1	5	$\mu\text{A}$
OUT Output Voltage	$V_{\text{IN}} = 2.7\text{V}$ to $4.2\text{V}$ , load = 0 to 12mA	MAX1686	4.55	4.75	5.25	V
		MAX1686H	4.75	5.00	5.25	
	$3/\overline{5} = \text{IN}$			$V_{\text{IN}}$		
IN-to-OUT Switch On-Resistance	$V_{3/\overline{5}} = V_{\text{IN}} = 3.0\text{V}$			2.5	5	$\Omega$
OUT Discharge Switch On-Resistance	$3/\overline{5} = \text{GND}$ or $\text{IN}$ , $\overline{\text{SHDN}} = \text{GND}$			80	200	$\Omega$
OUT Short-Circuit Current	$3/\overline{5} = \text{GND}$ or $\text{IN}$		20	100	200	mA
Logic Input Low Voltage	$\overline{\text{SHDN}}$ , $3/\overline{5}$			$0.5 \cdot V_{\text{IN}}$	$0.3 \cdot V_{\text{IN}}$	V
Logic Input High Voltage	$\overline{\text{SHDN}}$ , $3/\overline{5}$		$0.7 \cdot V_{\text{IN}}$	$0.5 \cdot V_{\text{IN}}$		V
Logic Input Leakage Current	$\overline{\text{SHDN}}$ , $3/\overline{5} = \text{GND}$ or $\text{IN}$			0.1	1	$\mu\text{A}$
Charge-Pump Frequency	$T_A = +25^\circ\text{C}$		800	1000	1200	kHz
	$T_A = -40^\circ\text{C}$ to $+85^\circ\text{C}$		700		1300	

**Note 1:** Electrical specifications are measured by pulse testing and are guaranteed for a junction temperature within the operating temperature range, unless otherwise noted. Limits are 100% production tested at  $T_A = +25^\circ\text{C}$ . Limits over the entire operating temperature range are guaranteed through correlation using Statistical Quality Control (SQC) methods and are not production tested.

# 3V to 5V Regulating Charge Pumps for SIM Cards

## Typical Operating Characteristics

(See Typical Operating Circuit,  $C_{IN} = 0.47\mu\text{F}$ ,  $C_X = 0.22\mu\text{F}$ ,  $C_{OUT} = 10\mu\text{F}$ ,  $V_{IN} = 3.3\text{V}$ ,  $T_A = +25^\circ\text{C}$ , unless otherwise noted.)

MAX1686/MAX1686H

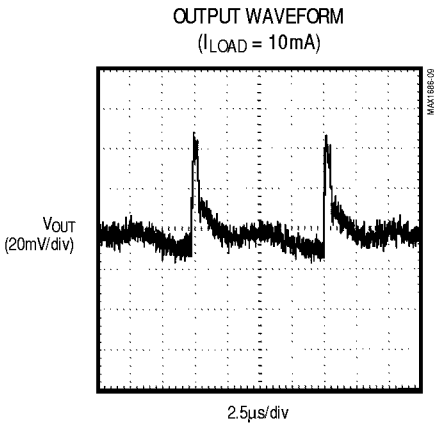
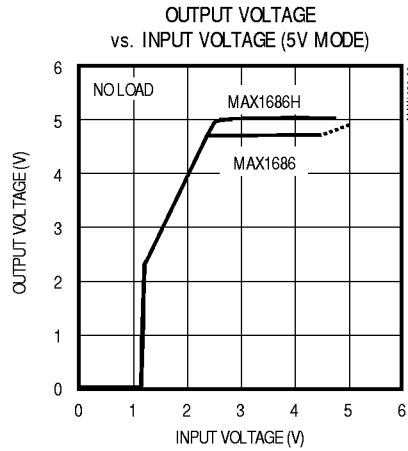
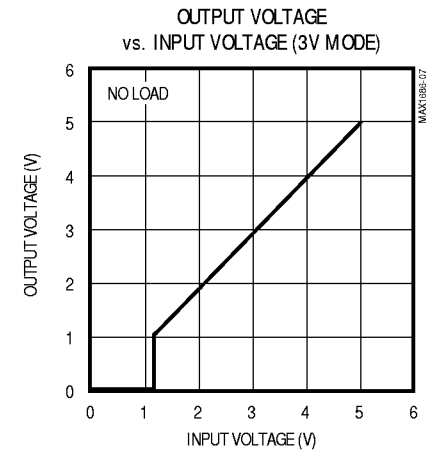
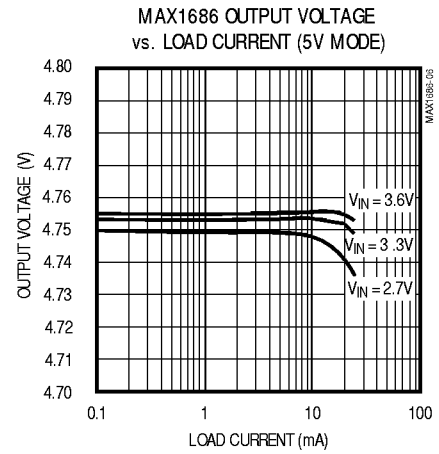
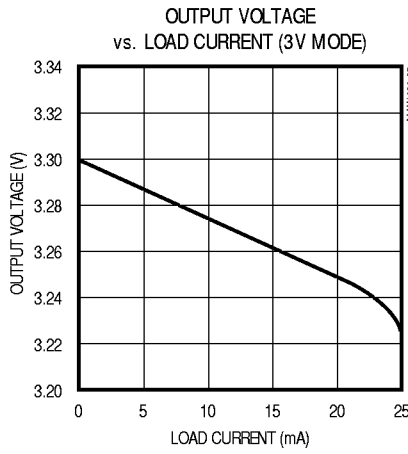
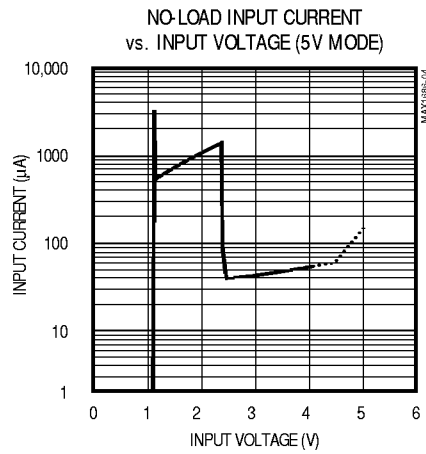
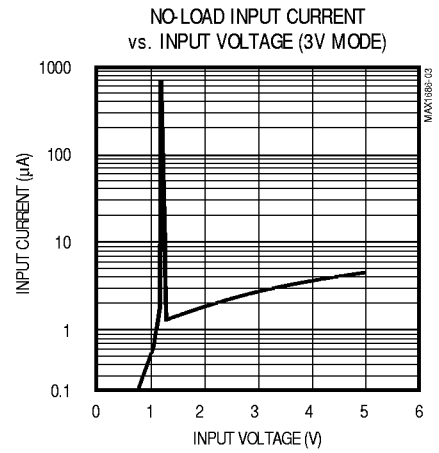
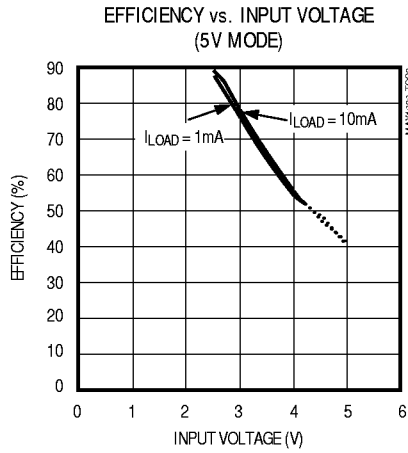
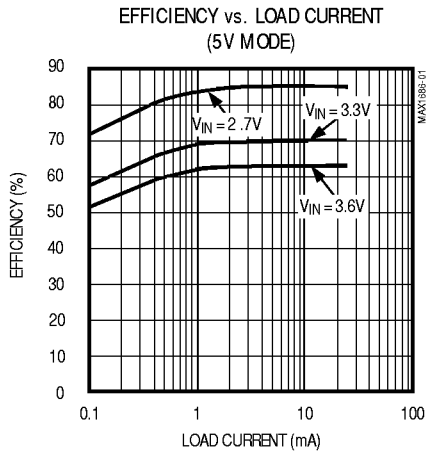

5V MODE, AC COUPLED,  
 $C_{OUT} = 10\mu\text{F} \parallel 0.1\mu\text{F}$

# 3V to 5V Regulating Charge Pumps for SIM Cards

## Typical Operating Characteristics (continued)

(See Typical Operating Circuit,  $C_{IN} = 0.47\mu\text{F}$ ,  $C_X = 0.22\mu\text{F}$ ,  $C_{OUT} = 10\mu\text{F}$ ,  $V_{IN} = 3.3\text{V}$ ,  $T_A = +25^\circ\text{C}$ , unless otherwise noted.)

OUTPUT WAVEFORM  
( $I_{LOAD} = 1\text{mA}$ )

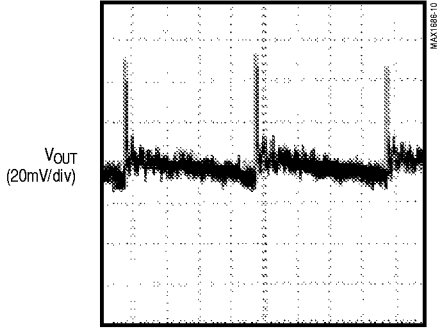

5V MODE, AC COUPLED,  
 $C_{OUT} = 10\mu\text{F} \parallel 0.1\mu\text{F}$

LINE-TRANSIENT RESPONSE

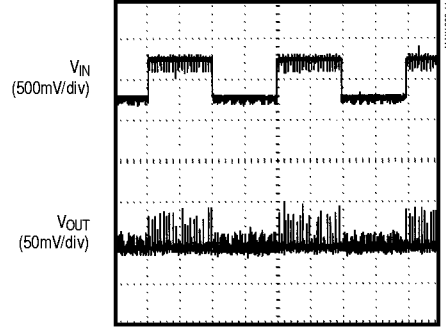

$V_{IN} = 2.8\text{V}$  to  $3.3\text{V}$ ,  $I_{LOAD} = 10\text{mA}$ , 5V MODE,  
AC COUPLED

LOAD-TRANSIENT RESPONSE

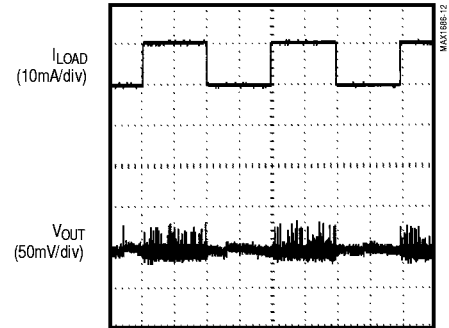

$I_{LOAD} = 0$  TO  $10\text{mA}$ , 5V MODE, AC COUPLED

START-UP WAVEFORM  
(3V MODE,  $R_L = 500\Omega$ )

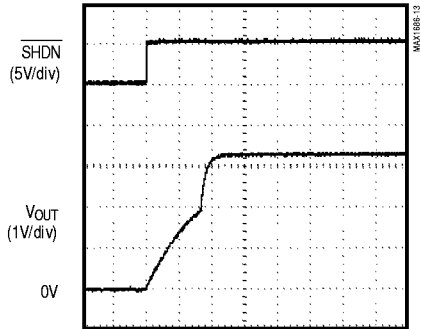

START-UP WAVEFORM  
(5V MODE,  $R_L = 500\Omega$ )

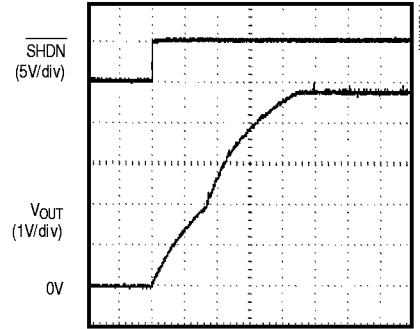

3V MODE TO 5V MODE  
WAVEFORM ( $R_L = 500\Omega$ )

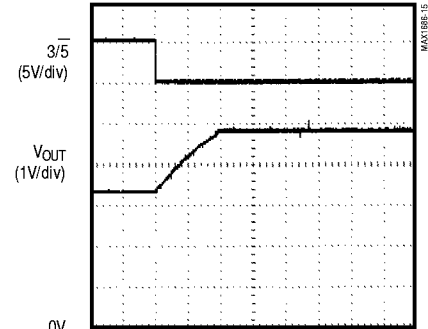

SHUTDOWN WAVEFORM  
(3V MODE, NO LOAD)

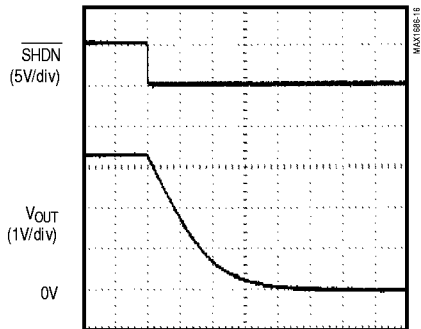

$R_L = 500\Omega$

SHUTDOWN WAVEFORM  
(5V MODE, NO LOAD)

