

MMA043AA Datasheet
0.5 GHz–12 GHz GaAs pHEMT MMIC Wideband
Low-Noise Amplifier



**Microsemi Corporate Headquarters**

One Enterprise, Aliso Viejo,
CA 92656 USA

Within the USA: +1 (800) 713-4113

Outside the USA: +1 (949) 380-6100

Fax: +1 (949) 215-4996

Email: sales.support@microsemi.com

www.microsemi.com

©2016 Microsemi Corporation. All rights reserved. Microsemi and the Microsemi logo are registered trademarks of Microsemi Corporation. All other trademarks and service marks are the property of their respective owners.

Microsemi makes no warranty, representation, or guarantee regarding the information contained herein or the suitability of its products and services for any particular purpose, nor does Microsemi assume any liability whatsoever arising out of the application or use of any product or circuit. The products sold hereunder and any other products sold by Microsemi have been subject to limited testing and should not be used in conjunction with mission-critical equipment or applications. Any performance specifications are believed to be reliable but are not verified, and Buyer must conduct and complete all performance and other testing of the products, alone and together with, or installed in, any end-products. Buyer shall not rely on any data and performance specifications or parameters provided by Microsemi. It is the Buyer's responsibility to independently determine suitability of any products and to test and verify the same. The information provided by Microsemi hereunder is provided "as is, where is" and with all faults, and the entire risk associated with such information is entirely with the Buyer. Microsemi does not grant, explicitly or implicitly, to any party any patent rights, licenses, or any other IP rights, whether with regard to such information itself or anything described by such information. Information provided in this document is proprietary to Microsemi, and Microsemi reserves the right to make any changes to the information in this document or to any products and services at any time without notice.

About Microsemi

Microsemi Corporation (Nasdaq: MSCC) offers a comprehensive portfolio of semiconductor and system solutions for aerospace & defense, communications, data center and industrial markets. Products include high-performance and radiation-hardened analog mixed-signal integrated circuits, FPGAs, SoCs and ASICs; power management products; timing and synchronization devices and precise time solutions, setting the world's standard for time; voice processing devices; RF solutions; discrete components; enterprise storage and communication solutions; security technologies and scalable anti-tamper products; Ethernet solutions; Power-over-Ethernet ICs and midspans; as well as custom design capabilities and services. Microsemi is headquartered in Aliso Viejo, California, and has approximately 4,800 employees globally. Learn more at www.microsemi.com.

1 Revision History

The revision history describes the changes that were implemented in the document. The changes are listed by revision, starting with the most current publication.

1.1 Revision 1.0

Revision 1.0 was the first publication of this document.

Contents

1	Revision History.....	3
1.1	Revision 1.0.....	3
2	Product Overview	7
2.1	Applications	7
2.2	Key Features.....	8
3	Electrical Specifications.....	9
3.1	Absolute Maximum Ratings	9
3.2	Typical Electrical Performance	9
3.3	Typical Performance Curves.....	10
4	Chip Outline Drawing, Die Packaging, Bond Pad, and Assembly Information	16
4.1	Chip Outline Drawing	16
4.2	Die Packaging Information	16
4.3	Bond Pad Information	17
4.4	Assembly Diagram	18
4.5	Bias Sequence Procedure.....	18
5	Handling and Die Attach Recommendations	19
6	Ordering Information	20

List of Figures

Figure 1 Functional Block Diagram	7
Figure 2 Gain vs. Frequency	10
Figure 3 Input Return Loss vs. Frequency	10
Figure 4 Output Return Loss vs. Frequency	11
Figure 5 Isolation vs. Frequency	11
Figure 6 Noise Figure vs. Frequency	12
Figure 7 P1dB vs. Frequency	12
Figure 8 OIP3 vs. Frequency.....	13
Figure 9 Gain vs. Temperature and Frequency.....	13
Figure 10 Input Return Loss vs. Temperature and Frequency.....	14
Figure 11 Output Return Loss vs. Temperature and Frequency.....	14
Figure 12 P1dB vs. Temperature and Frequency.....	15
Figure 13 OIP3 vs. Temperature and Frequency.....	15
Figure 14 Chip Outline	16
Figure 15 Assembly Diagram	18

List of Tables

Table 1 Absolute Maximum Ratings	9
Table 2 Typical Electrical Performance	9
Table 3 Die Packaging Information	16
Table 4 Bond Pad Information	17
Table 5 Ordering Information	20

2 Product Overview

The MMA043AA is a gallium arsenide (GaAs) pseudomorphic high-electron mobility transistor (pHEMT) low-noise wideband amplifier die that operates between 0.5 GHz and 12 GHz. The MMA043AA die provides 16.5 dB of gain, 1.4 dB noise figure, and 29 dBm output IP3. The amplifier draws only 55 mA of current from a 5 V supply. The RF ports are internally matched to 50 Ω , which allows for easy integration into multi-chip modules (MCMs).

The following illustration shows the primary functional diagram of the MMA043AA device.

Figure 1 Functional Block Diagram

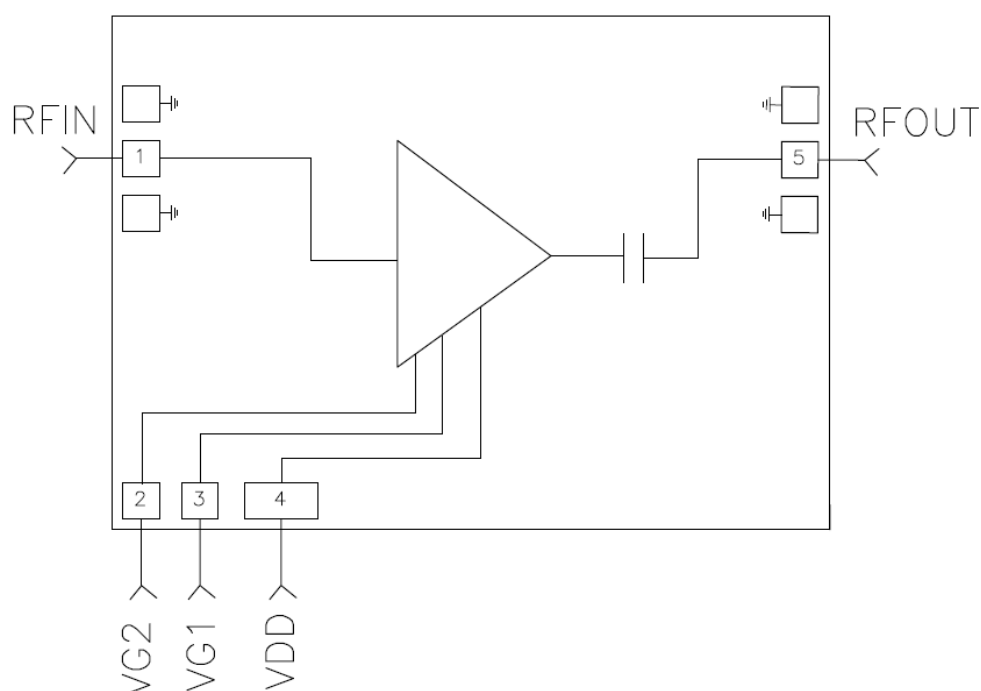

2.1 Applications

The MMA043AA device is designed for the following applications:

- Test instrumentation
- Wideband communications
- Military and space systems
- Cellular infrastructure
- Microwave radio and VSAT

2.2 Key Features

The following are key features of the MMA043AA device.

- GaAs pHEMT LNA monolithic microwave integrated circuit (MMIC)
- Low-noise figure: 1.4 dB
- High gain: 16.5 dB
- Broadband Performance: 0.5 GHz – 12 GHz
- Excellent P1dB output power (17 dBm)
- High OIP3: 29 dBm
- Compact die size: 2.2 mm × 1.35 mm × 0.1 mm

3 Electrical Specifications

3.1 Absolute Maximum Ratings

The following table shows the absolute maximum ratings of the MMA043AA device.

Table 1 Absolute Maximum Ratings

Parameter	Rating
Storage temperature	–65 °C to 150 °C
Operating temperature	–55 °C to 85 °C
Drain bias voltage (V_{DD})	5.5 V
Gate bias voltage (V_{G1})	–1.5 V to 0 V
Gate bias voltage (V_{G2})	0 V to 2.5 V
RF input power	12 dBm
Channel temperature	150 °C
ESD sensitivity (HBM)	
Thermal impedance	

3.2 Typical Electrical Performance

The following table shows the typical electrical performance of the MMA043AA device at 25 °C, where V_{DD} is 5 V. Unless otherwise indicated, all measurements are derived from the RF probed die according to the assembly diagram shown in [Assembly Diagram](#).

Table 2 Typical Electrical Performance

Parameter	Min	Typ	Max	Units
Operational frequency range		0.5	12	GHz
Gain	15.4	16.5	17.2	dB
Gain variation over temperature		0.01		dB/°C
Noise figure	1.2	1.4	2.1	dB
Input return loss	7.5	10		dB
Output return loss	12	13		dB
Output power for 1 dB compression, P1dB	16.5	17	18.5	dBm
Output third order intercept, OIP3	27.5	29		dBm
V_{DD}		5	5.5	V
Supply current (I_{DD}); $V_{DD} = 5$ V $V_{G2} = 1.7$ V typ $V_{G1} = -0.4$ V, set for nominal current		55		mA

3.3 Typical Performance Curves

The following graphs show the typical performance curves of the MMA043AA device.

Figure 2 Gain vs. Frequency

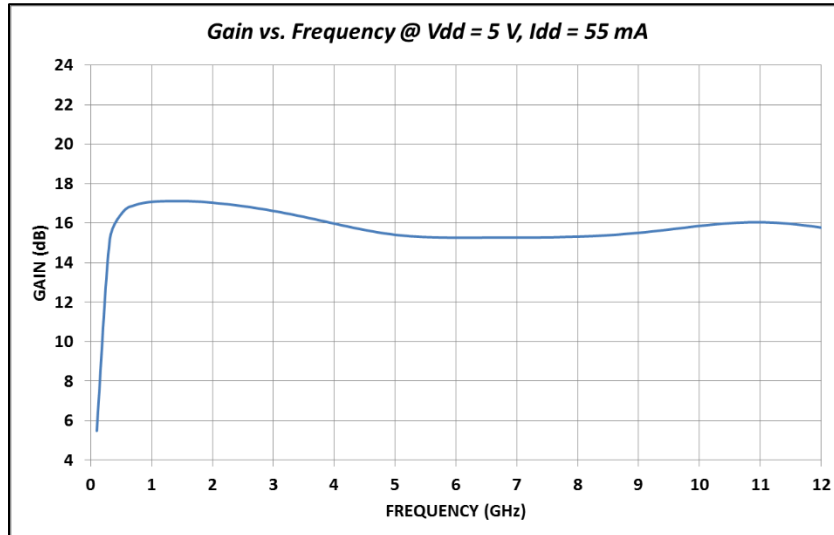

Figure 3 Input Return Loss vs. Frequency

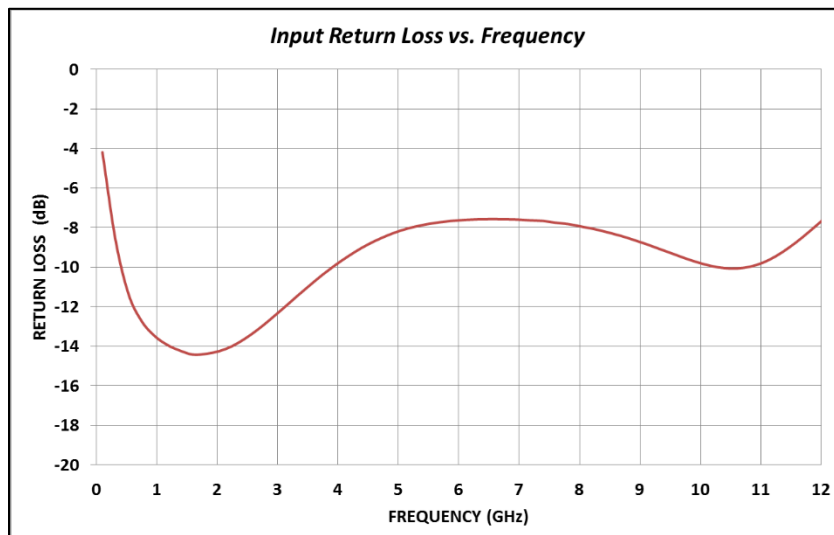

Figure 4 Output Return Loss vs. Frequency

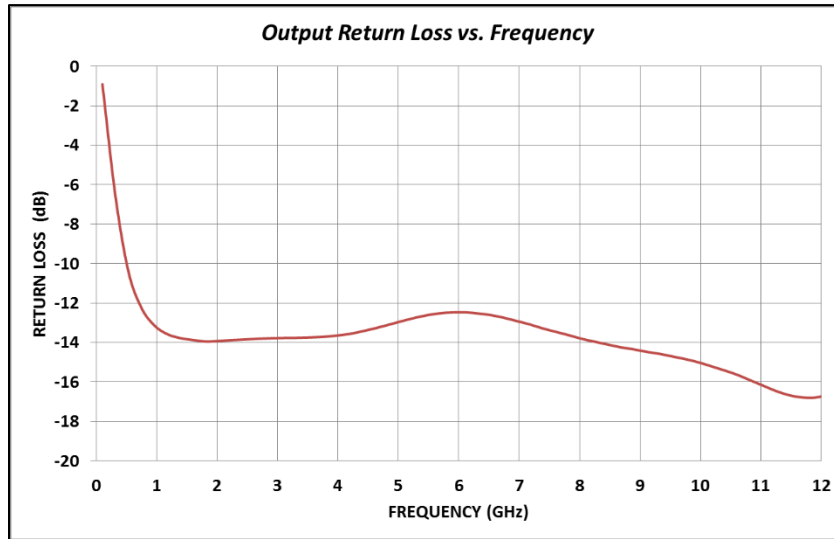

Figure 5 Isolation vs. Frequency

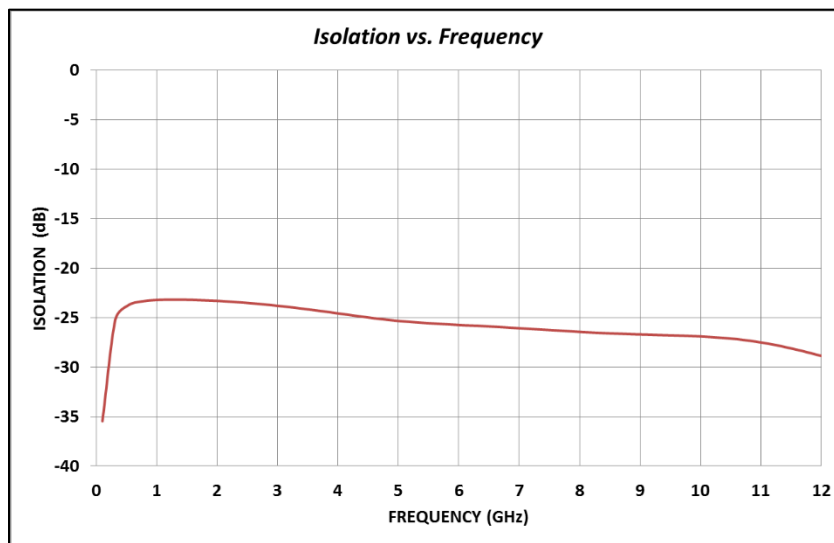

Figure 6 Noise Figure vs. Frequency

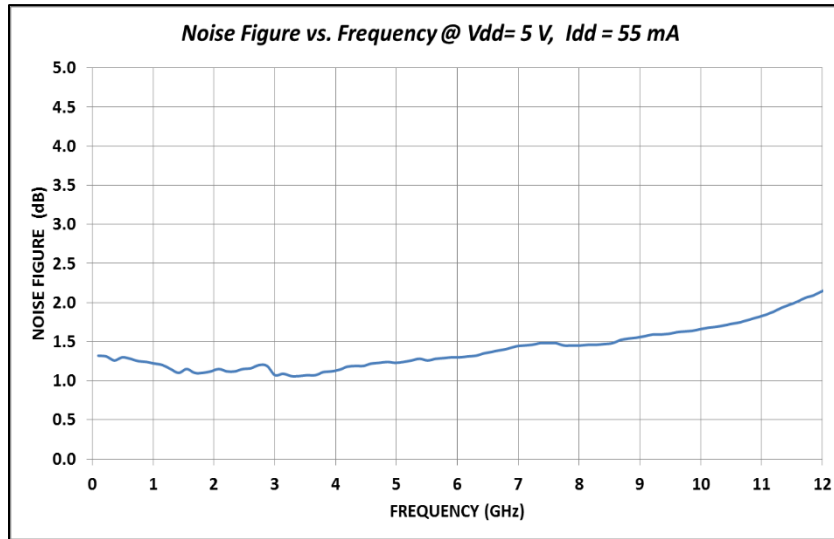

Figure 7 P1dB vs. Frequency

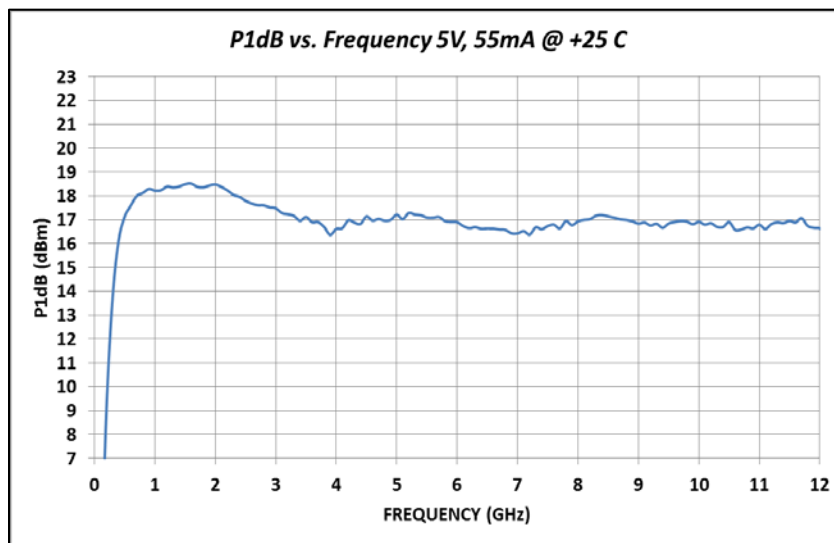

Figure 8 OIP3 vs. Frequency

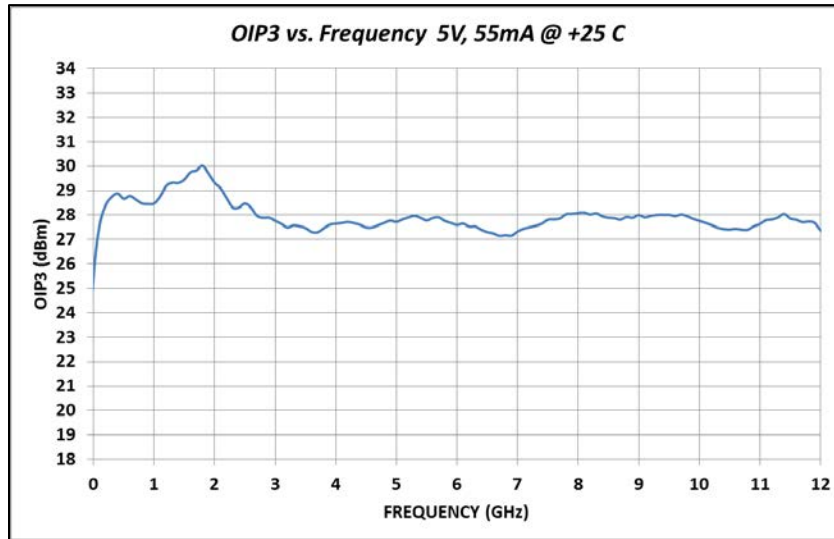

Figure 9 Gain vs. Temperature and Frequency

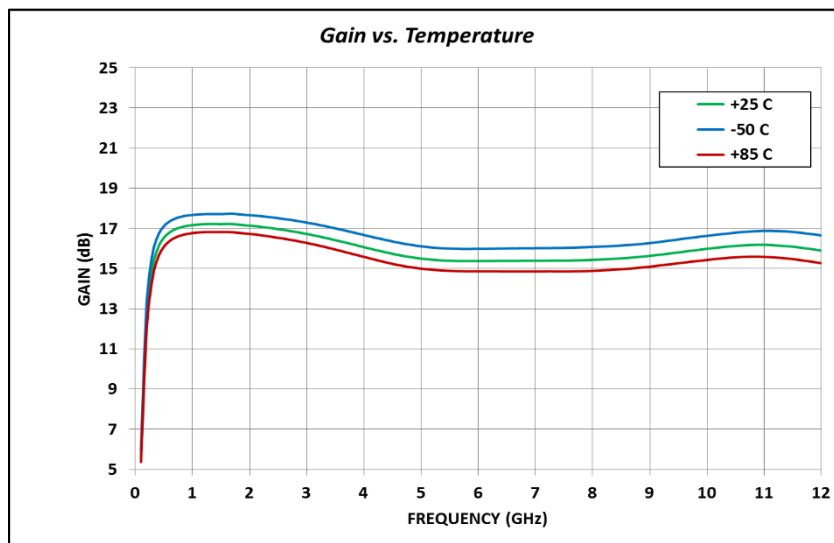

Figure 10 Input Return Loss vs. Temperature and Frequency

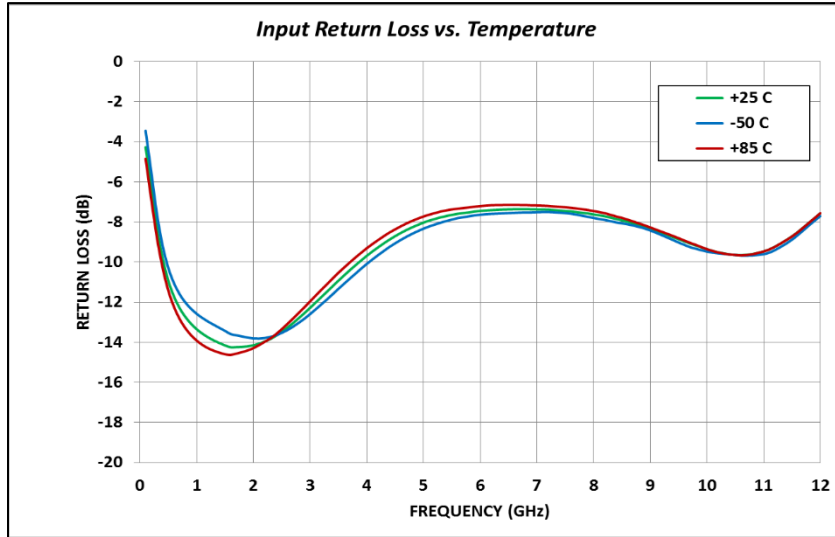

Figure 11 Output Return Loss vs. Temperature and Frequency

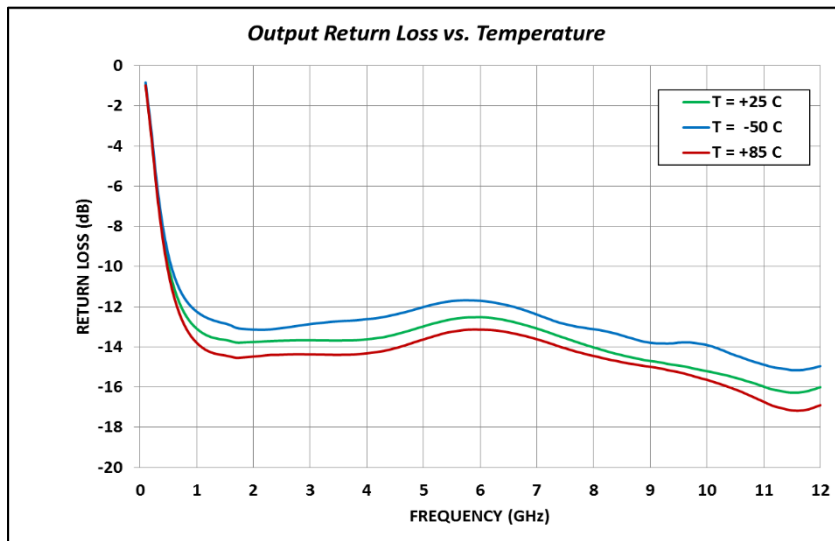

Figure 12 P1dB vs. Temperature and Frequency

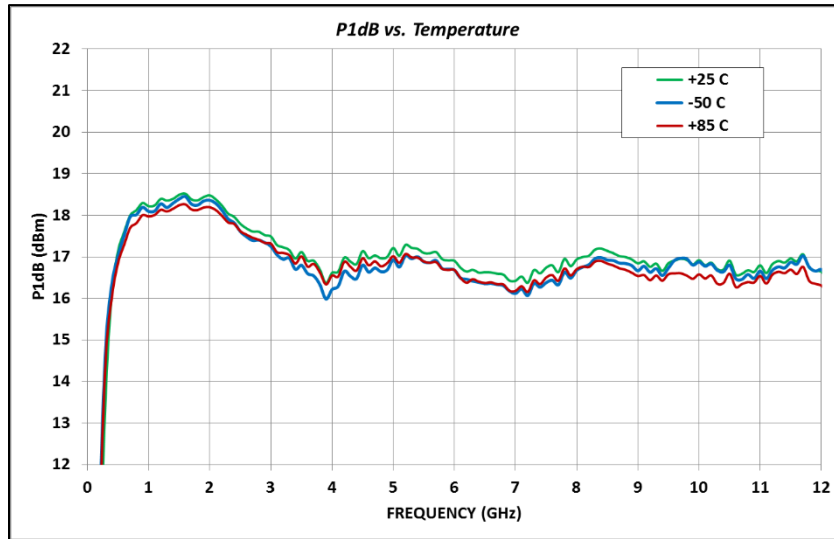
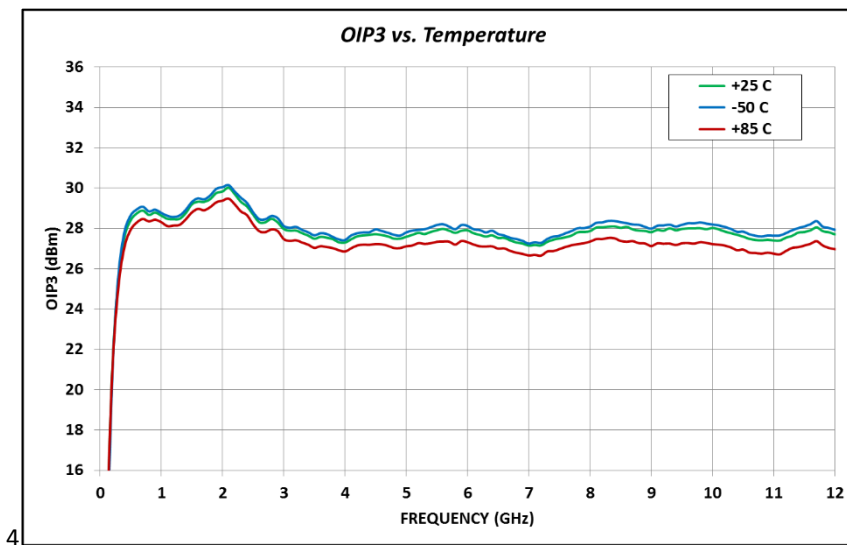

Figure 13 OIP3 vs. Temperature and Frequency



4 Chip Outline Drawing, Die Packaging, Bond Pad, and Assembly Information

4.1 Chip Outline Drawing

The following illustration shows the chip outline of the MMA043AA device. Dimensions are shown in inches and millimeters. The minimum bond pad size is $100\ \mu\text{m} \times 100\ \mu\text{m}$. Both the bond pad surface and the backside metal are $3\ \mu\text{m}$ gold. The die thickness is $100\ \mu\text{m}$. The backside is the DC/RF ground. The airbridge keepout region is in crosshatch, and the unlabeled pads should not be bonded.

Figure 14 Chip Outline

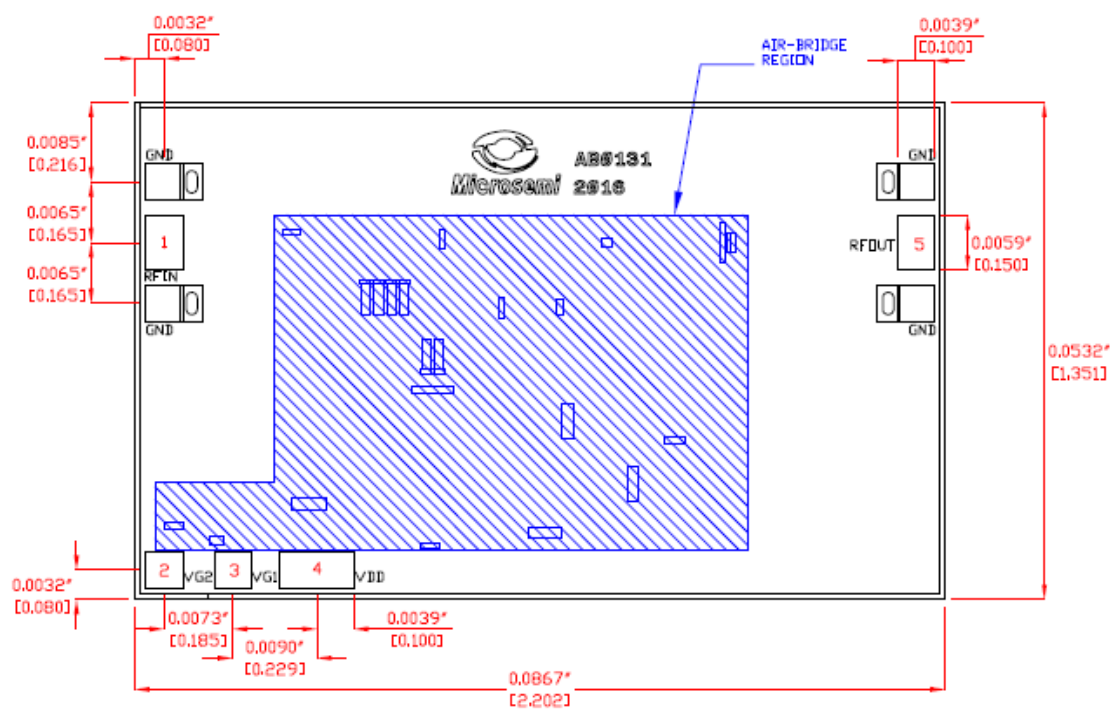

4.2 Die Packaging Information

The following table shows the chip outline of the MMA043AA device. For additional packaging information, contact your Microsemi sales representative.

Table 3 Die Packaging Information

Standard Format	Optional Format
Waffle pack	Gel pack
50–100 pieces per pack	50 pieces per pack

4.3 Bond Pad Information

The following table shows the bond pad information for the MMA043AA device.

Table 4 Bond Pad Information

Bond Pad Number	Bond Pad Name	Description
1	RF _{IN}	This bond pad is DC-coupled and matched to 50 Ω. External >300 pF DC blocking capacitor is required.
2	V _{G2}	Gate 2 supply voltage for the amplifier. See Assembly Diagram for required external components.
3	V _{G1}	Gate 1 supply voltage for the amplifier. See Assembly Diagram for required external components.
4	V _{DD}	Drain supply voltage for the amplifier. See Assembly Diagram for required external components.
5	RF _{OUT}	This bond pad is AC-coupled and matched to 50 Ω.
Backside paddle	RF/DC GND	RF/DC ground.

4.4 Assembly Diagram

The following illustration shows the assembly diagram of the MMA043AA device. The carrier plate is gold plated. It is necessary to attach components using conductive epoxy. The bypass chip caps are ceramic and must be assembled within 10 mils of the die. Use 1 mil Au bond wires. An input blocking capacitor greater than 300 pF is required external to the MMIC.

Figure 15 Assembly Diagram

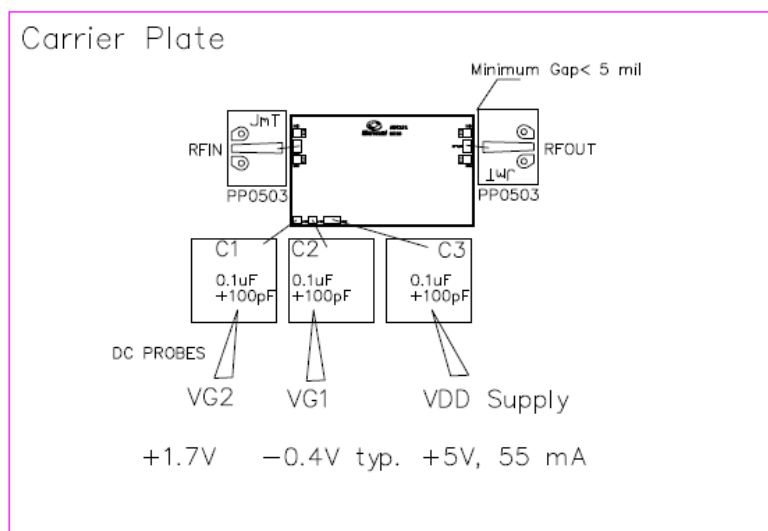

BOM: C1, C2, C3: Presidio VB series dual caps (100 pF + 0.1 μ F)

P/N: MVB4040X104MEK5C1B; 40 mils \times 40 mils \times 17 mils

4.5 Bias Sequence Procedure

The following lists show the bias sequence procedures for the MMA043AA device.

Turn on:

1. Set V_{G1} (-ve) to -1 V
2. Set V_{DD} to 5 V
3. Set V_{G2} to 1.7 V
4. Increase V_{G1} to achieve I_{dq} of 55 mA
5. Apply RF input

Turn off:

1. Turn off RF input
2. Reduce V_{G1} to -1 V to achieve I_{dq} of 0 mA
3. Decrease V_{G2} to 0 V
4. Decrease V_{DD} to 0 V

5 Handling and Die Attach Recommendations

Gallium arsenide integrated circuits are sensitive to electrostatic discharge (ESD) and can be damaged by static electricity. It is recommended to follow all procedures and guidelines outlined in Microsemi application note [AN01 GaAs MMIC Handling and Die Attach Recommendations](#).

6 Ordering Information

The following table shows the ordering information for the MMA043AA device.

Table 5 Ordering Information

Part Number	Package
MMA043AA	Die