

F1471

0.5W High Linearity RF Amplifier 400MHz to 4200MHz

The F1471 is a high linearity RF Driver Amplifier designed to operate within the 400MHz to 4200MHz frequency band. Using a single 5V power supply and only 130mA of I_{CQ} , the F1471 provides 15dB of gain and 3.8dB of noise figure, and 29dBm OP1dB at 3600MHz.

The F1471 is packaged in a 3 × 3 mm, 16-VFQFPN package, with matched 50Ω input and output impedances for ease of integration into the signal path.

Competitive Advantage

- Excellent linearity maintained over large bandwidths
- OIP3 linearity configurable with bias current adjustments
- Exceptional OP1dB performance maintained at low bias currents
- Robust ESD Performance
 - 1.5kV HBM ESD rating
 - 1kV CDM ESD rating
- Includes on-chip DC overvoltage and RF overdrive protection

Features

- RF range: 400MHz to 4200MHz
- 15dB typical gain at 3600MHz
- 3.8dB NF at 3600MHz
- +29dBm output P1dB at 3600MHz
- 5V power supply
- Adjustable DC bias
- Bias control compatible for 3.3V and 5V VREF operation allowing power-down mode for power savings
- 50Ω single-ended input and output impedances
- Internal DC overvoltage protection
- Internal RF overdrive protection
- On-chip ESD protection
- Operating temperature (T_{EP}) range: -40°C to +115°C
- 3 × 3 mm, 16-VFQFPN package

Applications

- 4G/5G cellular base stations
- Multi-mode, multi-carrier transmitters
- Active antenna systems
- General purpose wireless

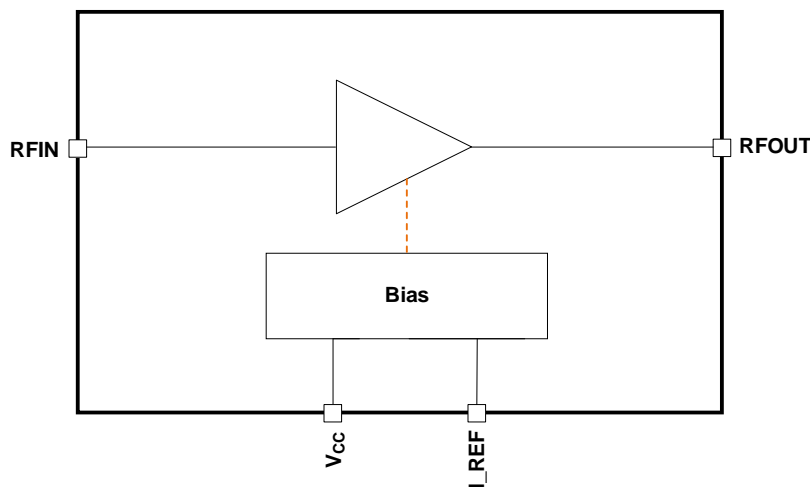

Figure 1. Block Diagram

Contents

1. Pin Information	4
1.1 Pin Configuration	4
1.2 Pin Descriptions	4
2. Specifications	5
2.1 Absolute Maximum Ratings	5
2.2 Recommended Operating Conditions	5
2.3 Electrical Characteristics	6
2.3.1. General	6
2.3.2. 2300MHz to 2900MHz	6
2.3.3. 3300MHz to 3900MHz	7
2.3.4. 3800MHz to 4200MHz	8
2.4 Thermal Characteristics	8
3. Typical Operating Conditions (TOC)	9
4. Typical Performance Characteristics	10
4.1 2300MHz to 2900MHz	10
4.2 3300MHz to 3900MHz	11
4.3 3800MHz to 4200MHz	12
5. Programming	14
6. Applications Information	14
6.1 Power Supplies	14
7. Evaluation Kit Information	14
7.1 Evaluation Kit Circuit	15
7.2 Bill of Materials	16
7.3 Evaluation Kit Operation	19
7.3.1. Power Supply Setup	19
7.3.2. Shunt Jumper Setup	19
7.3.3. Power-On Procedure	19
7.3.4. Power-Off Procedure	19
8. Package Outline Drawings	20
9. Ordering Information	20
10. Marking Diagram	20
11. Revision History	20

Figures

Figure 1. Block Diagram	1
Figure 2. Gain	10
Figure 3. Reverse Isolation	10
Figure 4. Input Return Loss	10
Figure 5. Output Return Loss	10
Figure 6. OIP3	10

Figure 7. OIP3 vs Tone Power (2.6GHz).....	10
Figure 8. OP1dB (2.6GHz)	11
Figure 9. Noise Figure	11
Figure 10. Gain	11
Figure 11. Reverse Isolation.....	11
Figure 12. Input Return Loss	11
Figure 13. Output Return Loss	11
Figure 14. OIP3	12
Figure 15. OIP3 vs Tone Power (3.6GHz).....	12
Figure 16. OP1dB (3.6GHz)	12
Figure 17. Noise Figure	12
Figure 18. Gain	12
Figure 19. Reverse Isolation.....	12
Figure 20. Input Return Loss	13
Figure 21. Output Return Loss	13
Figure 22. OIP3	13
Figure 23. OIP3 vs Tone Power (4GHz).....	13
Figure 24. OP1dB (4GHz)	13
Figure 25. Noise Figure	13
Figure 26. Evaluation Kit Photo	14
Figure 27. Electrical Schematic for the Evaluation Kit.....	15

Tables

Table 1. STBY Truth Table	14
Table 2. Evaluation Kit Bill of Material (BOM) – 2300MHz to 2900MHz Tune	16
Table 3. Evaluation Kit Bill of Material (BOM) – 3300MHz to 3900MHz Tune	17
Table 4. Evaluation Kit Bill of Material (BOM) – 3800MHz to 4200MHz Tune	18

1. Pin Information

1.1 Pin Configuration

16 Ld 3 x 3 mm VFQFPN Package
Top View

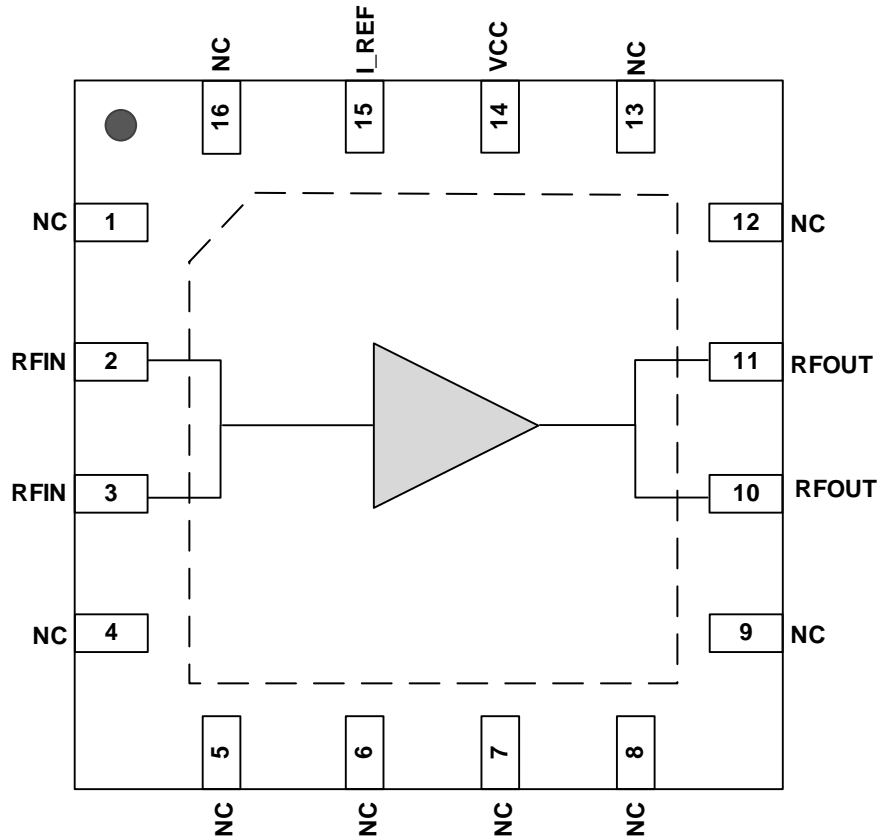

1.2 Pin Descriptions

Number	Name	Description
1, 4, 5, 6, 7, 8, 9, 12, 13, 16	NC	No internal connection. Renesas highly recommends connecting these pins to a ground via, which is located as close to the pin as possible.
2, 3	RFIN	RF input internally matched to 50Ω. Must use an external DC block.
10, 11	RFOUT	RF output. Pull up to V _{CC} through inductor. Must use an external DC block.
14	VCC	Connect pin directly to VCC. Renesas recommends placing a 1000pF decoupling capacitor as close to this pin as possible.
15	I_REF	Reference current and STBY pin. Connect an external resistor (reference BOM) to V _{REF} to set the quiescent current of the device. Setting V _{REF} < 2V disables the amplifier.
	EPAD	Exposed paddle. Internally connected to ground. Solder this exposed paddle to a printed circuit board (PCB) pad that uses multiple ground vias to provide heat transfer out of the device into the PCB ground planes. These multiple ground vias are also required to achieve the specified RF performance.

2. Specifications

2.1 Absolute Maximum Ratings

The absolute maximum ratings are stress ratings only. Stresses greater than those listed below can cause permanent damage to the device. Functional operation of the F1471 at absolute maximum ratings is not implied. Exposure to absolute maximum rating conditions may affect device reliability.

Parameter	Symbol	Minimum	Maximum	Units
V_{CC} to GND	V_{CC}	0	8.0	V
V_{REF} to GND	$V_{REF}^{[b]}$	0	5.5	V
RFIN Externally Applied DC Voltage	V_{RFIN}		8.0	V
RFOUT Externally Applied DC Voltage	V_{RFOUT}		8.0	V
Maximum CW input power applied for 24 hours $f = 2.6\text{GHz}$, $T_{EP} = +115^{\circ}\text{C}$, input/output VSWR < 2:1 based on 50 Ω system ^[a]	P_{MAXIN}		18	dBm
Junction Temperature	T_{JMAX}		+175	$^{\circ}\text{C}$
Storage Temperature Range	T_{STOR}	-65	+150	$^{\circ}\text{C}$
Lead Temperature (soldering, 10s)	T_{LEAD}		+260	$^{\circ}\text{C}$
Electrostatic Discharge – HBM (JEDEC/ESDA JS-001-2012)	V_{ESDHBM}		1500	V
Electrostatic Discharge – CDM (JEDEC 22-C101F)	V_{ESDCDM}		1000	V

[a] Exposure to these maximum RF levels can result in significantly higher I_{CC} current draw due to overdriving the amplifier stages.

[b] V_{REF} conditions apply when V_{CC} is applied

2.2 Recommended Operating Conditions

Parameter	Symbol	Condition	Minimum	Typical	Maximum	Units
Power Supply Voltage	V_{CC}		4.75		5.25	V
Reference Voltage	V_{REF}	Powered On		3.3 or 5 ^[a]		V
		Powered Off	0	1.8	2	
Operating Temperature Range	T_{EPAD}	Exposed Paddle	-40		+115	$^{\circ}\text{C}$
RF Frequency Range	f_{RF}		400		4200	MHz
RFIN Port Impedance	Z_{RFI}	Single-ended		50		Ω
RFOUT Port Impedance	Z_{RFO}	Single-ended		50		Ω

[a] Refer to R5 value in the BOM.

2.3 Electrical Characteristics

See the Electrical Schematic. Specifications apply when operated as a TX amplifier with tuning optimized for desired band of interest, $V_{CC} = +5.0V$, $V_{REF} = +3.3V$, $T_{EPAD} = +25^{\circ}C$, $R_{BSET} = 174\Omega$, (R_5 in the electrical schematic), $Z_S = Z_L = 50\Omega$, Evaluation Board (EVKit) traces and connectors are de-embedded, unless otherwise stated.

2.3.1. General

Parameter	Symbol	Condition	Minimum	Typical	Maximum	Units
Quiescent Current ^[b]	I_{CQ}			130	160 ^[a]	mA
Reference Bias Current ^[b]	I_{REF}			2		mA
	I_{REF_STBY}	$V_{REF} < 2V$		500		μA
Standby Switching Time	T_{ON}	50% STBY control to within 0.5dB of the on-state final gain value		200		ns
	T_{OFF}	50% STBY control to $I_{CC} < 10mA$		200		ns

2.3.2. 2300MHz to 2900MHz

See the Electrical Schematic. Specifications apply when operated as a TX amplifier with tuning optimized for the 2300MHz to 2900MHz band, $f_{RF} = 2600MHz$, $V_{CC} = +5.0V$, $V_{REF} = +3.3V$, $T_{EPAD} = +25^{\circ}C$, $R_{BSET} = 174\Omega$, (R_5 in the electrical schematic), $Z_S = Z_L = 50\Omega$, Evaluation Board (EVKit) traces and connectors are de-embedded, unless otherwise stated.

Parameter	Symbol	Condition	Minimum	Typical	Maximum	Units
Gain	G			16		dB
Gain Flatness	G_{FLAT}	$f_{RF} = 2300MHz$ to 2900MHz		1		dB
Gain Variation Over Temp	G_{TEMP}	$T_{EPAD} = -40^{\circ}C$ to $+115^{\circ}C$, referenced to $T_{EPAD} = 25^{\circ}C$		+0.5/-1		dB
STBY Mode Gain	G_{STBY}	$V_{REF} < 2V$		-16		dB
RF Input Return Loss	RL_{RFIN}			12		dB
RF Output Return Loss	RL_{RFOUT}			12		dB
Reverse Isolation	ISO_{REV}			27		dB
Noise Figure	NF			4		dB
Output Third Order Intercept Point	OIP3	$P_{OUT} = +18dBm/$ tone 1MHz tone separation		38		dBm
Output 1dB Compression Point	OP1dB			28.5		dBm
ACLR	ACLR	$P_{out} = +18dBm$, LTE 20MHz, 9dB PAR		-48		dBc

Parameter	Symbol	Condition	Minimum	Typical	Maximum	Units
Stability	K	K-Factor ^[b] T _{EPAD} = -40°C to +115°C V _{CC} = 4.75V to 5.25V Up to 20GHz	1			

[a] Specifications in the minimum/maximum columns that are shown in **bold italics** are confirmed by test. Specifications in these columns that are not shown in bold italics are confirmed by design characterization.

[b] K-Factor calculated taking the matching circuit into consideration, no de-embedding applied.

2.3.3. 3300MHz to 3900MHz

See the Electrical Schematic. Specifications apply when operated as a TX amplifier with tuning optimized for the 3300MHz to 3900MHz band, f_{RF} = 3600MHz, V_{CC} = +5.0V, V_{REF} = +3.3V, T_{EPAD} = +25°C, R_{BSET} = 174Ω, (R5 in the electrical schematic), Z_S = Z_L = 50Ω, Evaluation Board (EVKit) traces and connectors are de-embedded, unless otherwise stated.

Parameter	Symbol	Condition	Minimum	Typical	Maximum	Units
Gain	G		13^[a]	15		dB
Gain Flatness	G _{FLAT}	f _{RF} = 3300MHz to 3900MHz		1		dB
Gain Variation Over Temp	G _{TEMP}	T _{EPAD} = -40°C to +115°C, referenced to T _{EPAD} = 25°C		+0.5/-1		dB
STBY Mode Gain	G _{STBY}	V _{REF} < 2V		-14		dB
RF Input Return Loss	RL _{RFIN}			14		dB
RF Output Return Loss	RL _{RFOUT}			12		dB
Reverse Isolation	ISO _{REV}			25		dB
Noise Figure	NF			3.8		dB
Output Third Order Intercept Point	OIP3	P _{OUT} = +18dBm/tone 1MHz tone separation		38		dBm
		P _{OUT} = +18dBm/tone 1MHz tone separation V _{CC} = 4.75V to 5.25V T _{EPAD} = -40°C to +115°C	32			dBm
Output 1dB Compression Point	OP1dB			29		dBm
		V _{CC} = 4.75V to 5.25V T _{EPAD} = -40°C to +115°C	26			dBm
ACLR	ACLR	P _{out} = +18dBm, LTE 20MHz, 9dB PAR		-47		dBc
Stability	K	K-Factor ^[b] T _{EPAD} = -40°C to +115°C V _{CC} = 4.75V to 5.25V Up to 20GHz	1			

[a] Specifications in the minimum/maximum columns that are shown in **bold italics** are confirmed by test. Specifications in these columns that are not shown in bold italics are confirmed by design characterization.

[b] K-Factor calculated taking the matching circuit into consideration, no de-embedding applied.

2.3.4. 3800MHz to 4200MHz

See the Electrical Schematic. Specifications apply when operated as a TX amplifier with tuning optimized for the 3800MHz to 4200MHz band, $f_{RF} = 4000\text{MHz}$, $V_{CC} = +5.0\text{V}$, $V_{REF} = +3.3\text{V}$, $T_{EPAD} = +25^\circ\text{C}$, $R_{BSET} = 174\Omega$, (R5 in the electrical schematic), $Z_S = Z_L = 50\Omega$, Evaluation Board (EVKit) traces and connectors are de-embedded, unless otherwise stated.

Parameter	Symbol	Condition	Minimum	Typical	Maximum	Units
Gain	G			14		dB
Gain Flatness	G_{FLAT}	$f_{RF} = 3800\text{MHz to } 4200\text{MHz}$		1.2		dB
Gain Variation Over Temp	G_{TEMP}	$T_{EPAD} = -40^\circ\text{C to } +115^\circ\text{C}$, referenced to $T_{EPAD} = 25^\circ\text{C}$		+0.5/-1		dB
STBY Mode Gain	G_{STBY}	$V_{REF} < 2\text{V}$		-13		dB
RF Input Return Loss	RL_{RFIN}			15		dB
RF Output Return Loss	RL_{RFOUT}			9		dB
Reverse Isolation	ISO_{REV}			25		dB
Noise Figure	NF			3.8		dB
Output Third Order Intercept Point	OIP3	$P_{OUT} = +18\text{dBm/tone}$ 1MHz tone separation		37		dBm
Output 1dB Compression Point	OP1dB			28.5		dBm
ACLR	ACLR	$P_{out} = +18\text{dBm}$, LTE 20MHz, 9dB PAR		-44		dBc
Stability	K	K-Factor ^[b] $T_{EPAD} = -40^\circ\text{C to } +115^\circ\text{C}$ $V_{CC} = 4.75\text{V to } 5.25\text{V}$ Up to 20GHz	1			

- [a] Specifications in the minimum/maximum columns that are shown in **bold italics** are confirmed by test. Specifications in these columns that are not shown in bold italics are confirmed by design characterization.
- [b] K-Factor calculated taking the matching circuit into consideration, no de-embedding applied.

2.4 Thermal Characteristics

Parameter	Symbol	Value	Units
Junction to Ambient Thermal Resistance.	θ_{JA}	48.6	$^\circ\text{C/W}$
Junction to Case Thermal Resistance. (Case is defined as the exposed paddle)	θ_{JC-BOT}	4.3	$^\circ\text{C/W}$
Moisture Sensitivity Rating (Per J-STD-020)		MSL 1	

3. Typical Operating Conditions (TOC)

Unless otherwise noted, the following conditions apply for the TOC graphs on the following pages:

- $V_{CC} = 5.0V$
- $Z_L = Z_S = 50\Omega$ Single-ended
- $f_{RF} = 2600MHz$ (set 1)
- $f_{RF} = 3600MHz$ (set 2)
- $f_{RF} = 4000MHz$ (set 3)
- $T_{EP} = +25^{\circ}C$
- $V_{REF} = 3.3V$
- 1MHz Tone Spacing
- All temperatures are referenced to the exposed paddle.
- ACLR measurements used with LTE signal, 20MHz, PAR = 9dB at 0.01% probability.
- Evaluation Kit traces and connector losses are de-embedded

4. Typical Performance Characteristics

4.1 2300MHz to 2900MHz

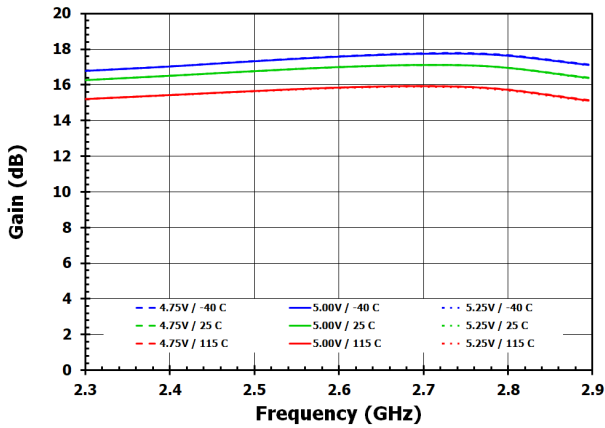

Figure 2. Gain

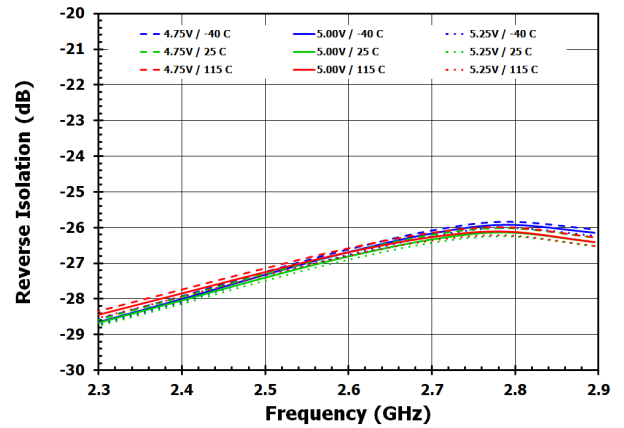

Figure 3. Reverse Isolation

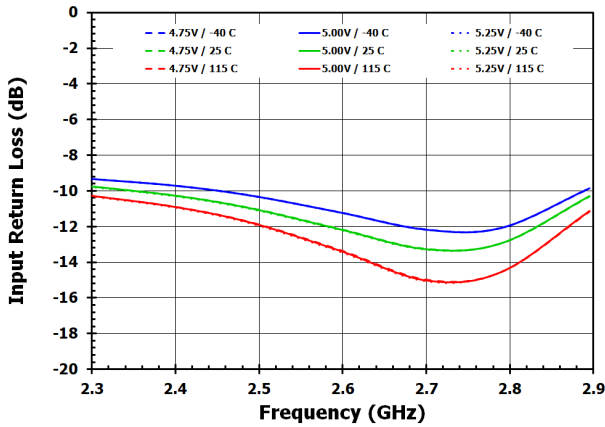

Figure 4. Input Return Loss

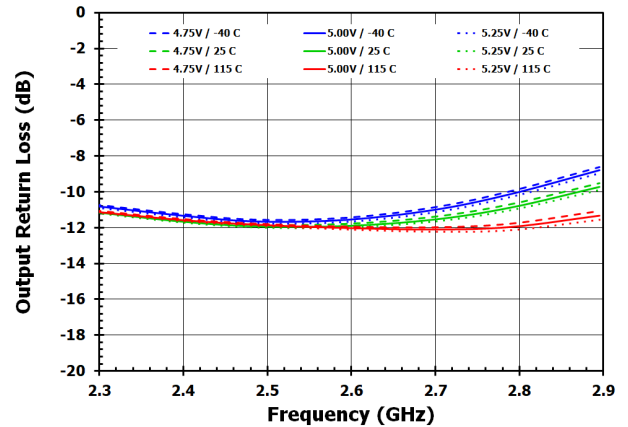

Figure 5. Output Return Loss

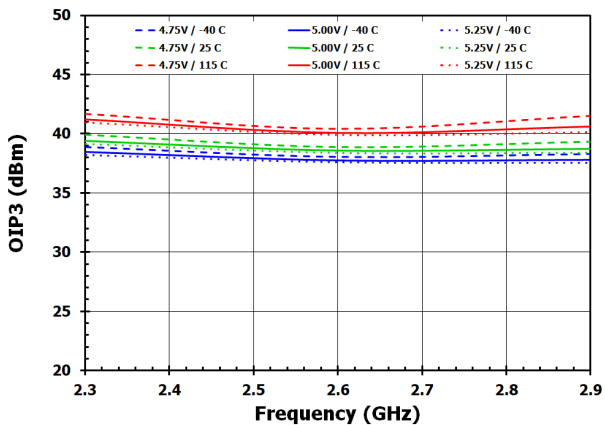

Figure 6. OIP3

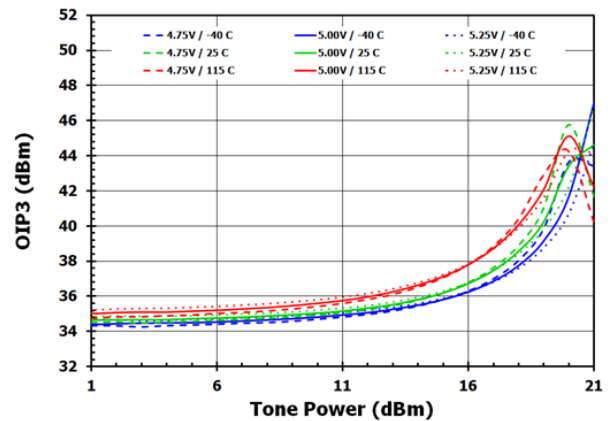

Figure 7. OIP3 vs Tone Power (2.6GHz)

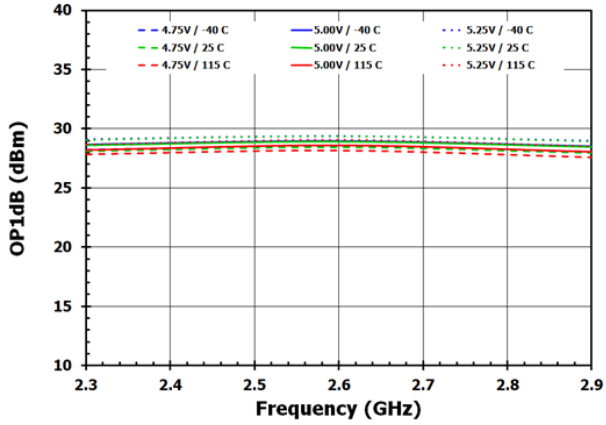

Figure 8. OP1dB (2.6GHz)

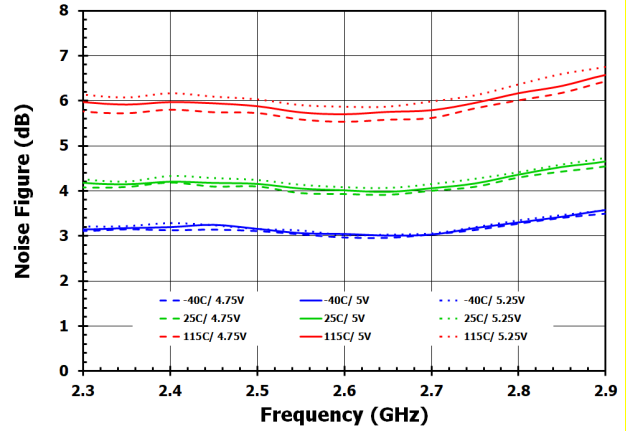

Figure 9. Noise Figure

4.2 3300MHz to 3900MHz

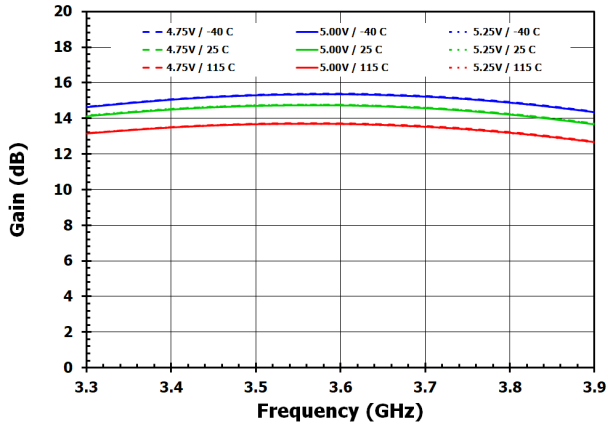

Figure 10. Gain

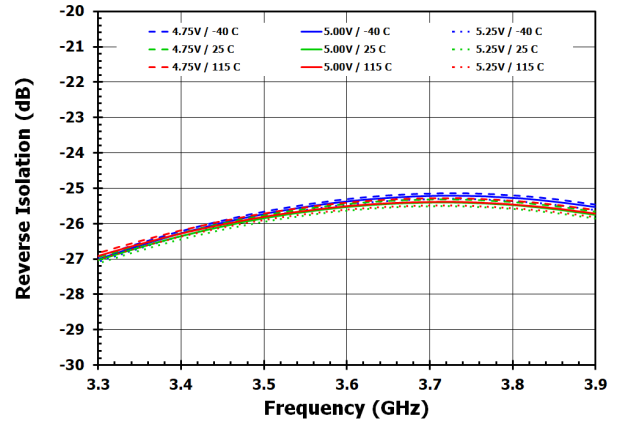

Figure 11. Reverse Isolation

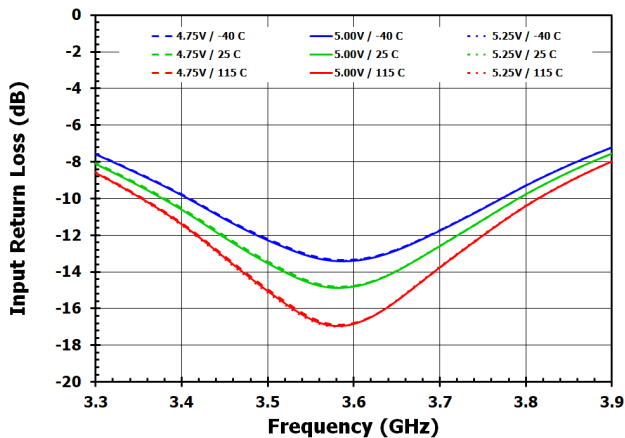

Figure 12. Input Return Loss

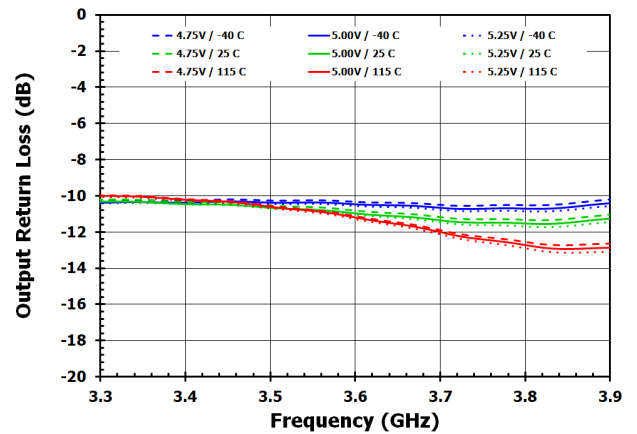

Figure 13. Output Return Loss

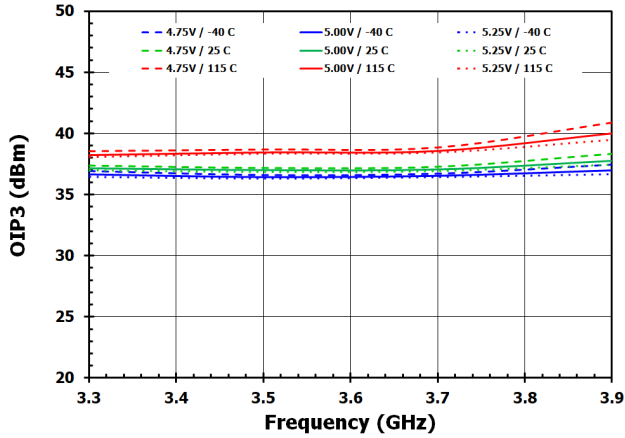

Figure 14. OIP3

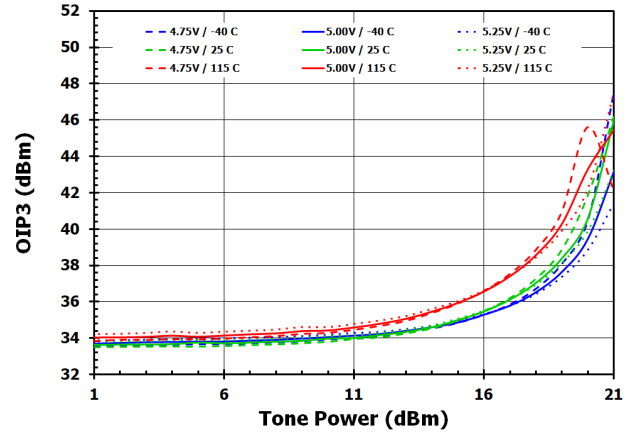

Figure 15. OIP3 vs Tone Power (3.6GHz)

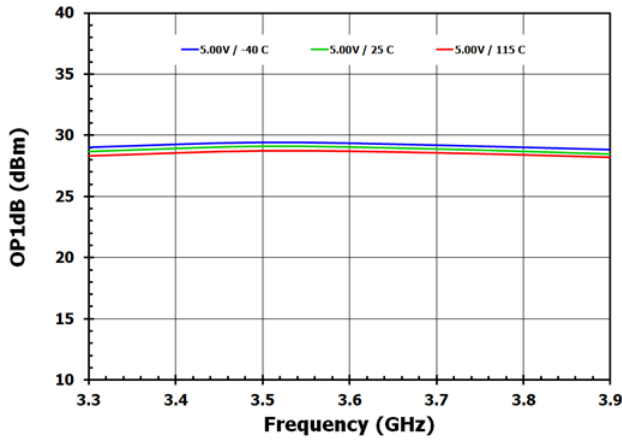

Figure 16. OP1dB (3.6GHz)

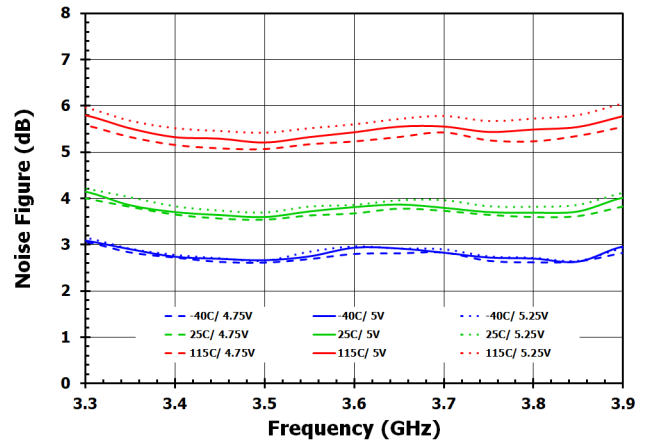

Figure 17. Noise Figure

4.3 3800MHz to 4200MHz

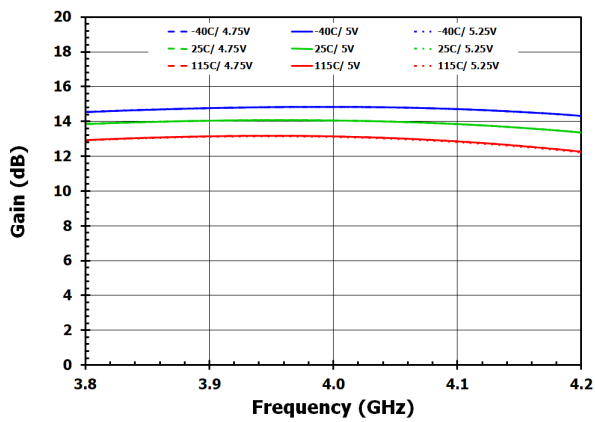

Figure 18. Gain

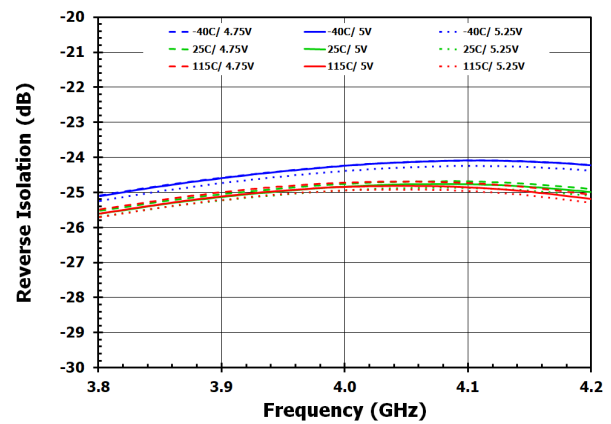

Figure 19. Reverse Isolation

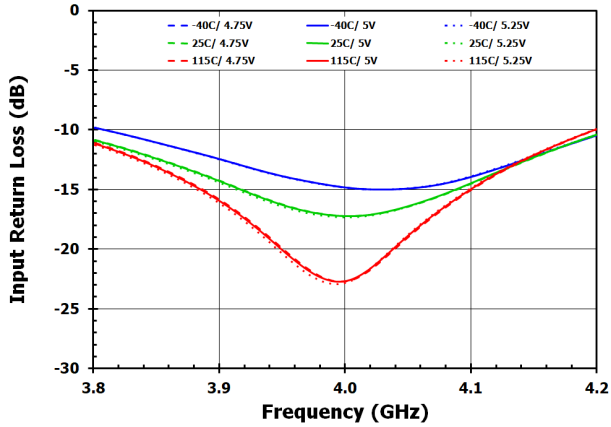

Figure 20. Input Return Loss

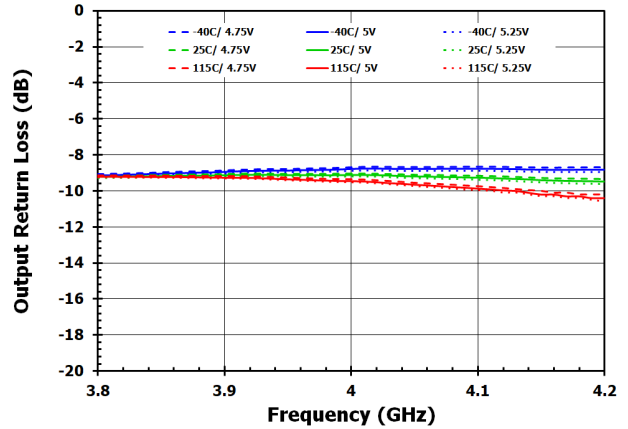

Figure 21. Output Return Loss

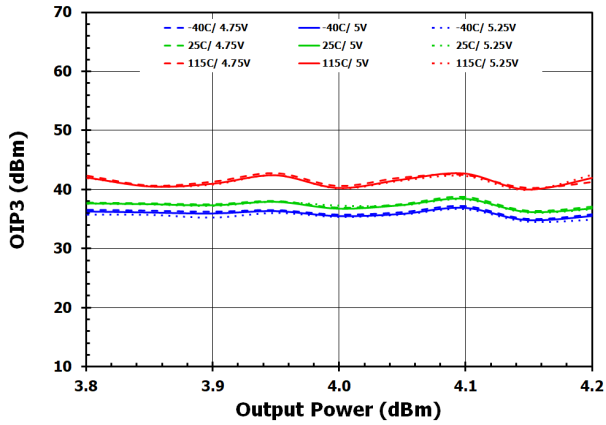

Figure 22. OIP3

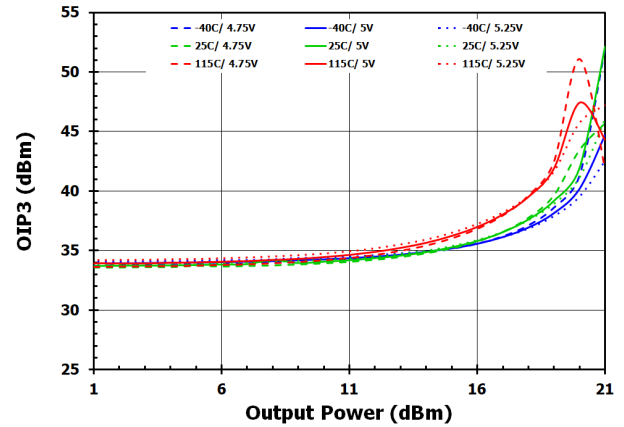

Figure 23. OIP3 vs Tone Power (4GHz)

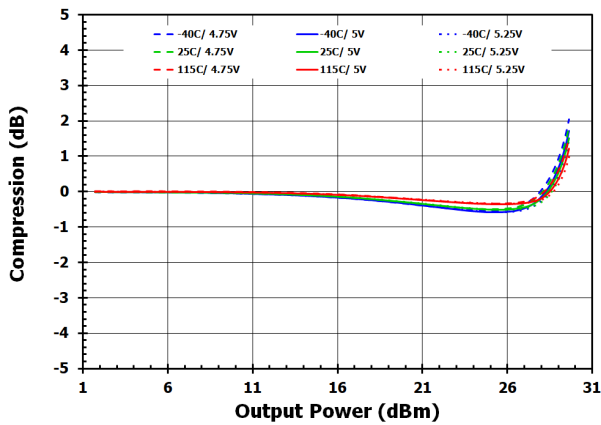

Figure 24. OP1dB (4GHz)

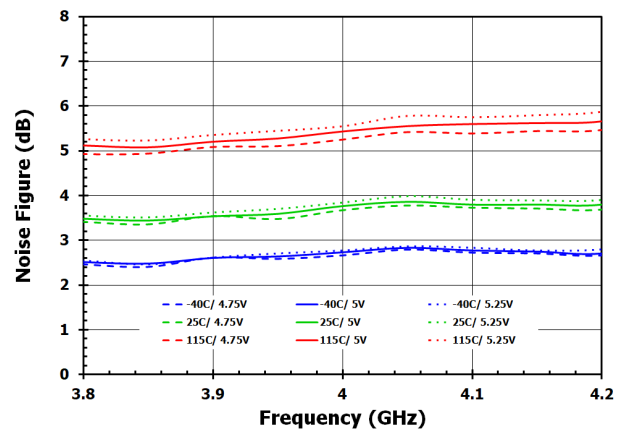

Figure 25. Noise Figure

5. Programming

The F1471 includes a STBY feature as defined in the following table.

Table 1. STBY Truth Table

V _{REF} Voltage	State	Condition
V _{REF} = 5V	Full operation	R _{BSET} = See R5 in band specific BOM
V _{REF} = 3.3V	Full operation	R _{BSET} = See R5 in band specific BOM
V _{REF} < 2V	Amplifier OFF	R _{BSET} = See R5 in band specific BOM

6. Applications Information

The F1471 has been optimized for use in high performance RF applications from 400MHz to 4200MHz.

6.1 Power Supplies

Use a common V_{CC} power supply for all power supply pins. To minimize noise and fast transients, de-coupling capacitors to all supply pins. Supply noise can degrade noise figure and fast transients can trigger ESD clamps causing them to fail. Supply voltage changes or transients should have a slew rate smaller than 1V/20μs. In addition, keep all control pins at 0V (±0.3V) while the supply voltage ramps or while it returns to zero.

7. Evaluation Kit Information

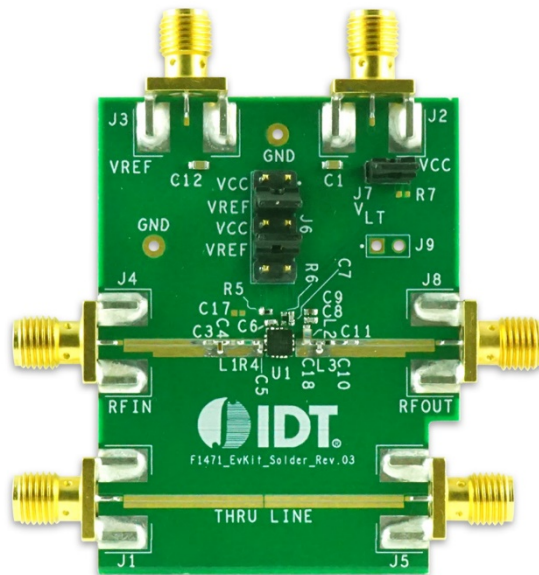

Figure 26. Evaluation Kit Photo

Note: See the Evaluation Kit Operation section for proper setup and configuration

7.1 Evaluation Kit Circuit

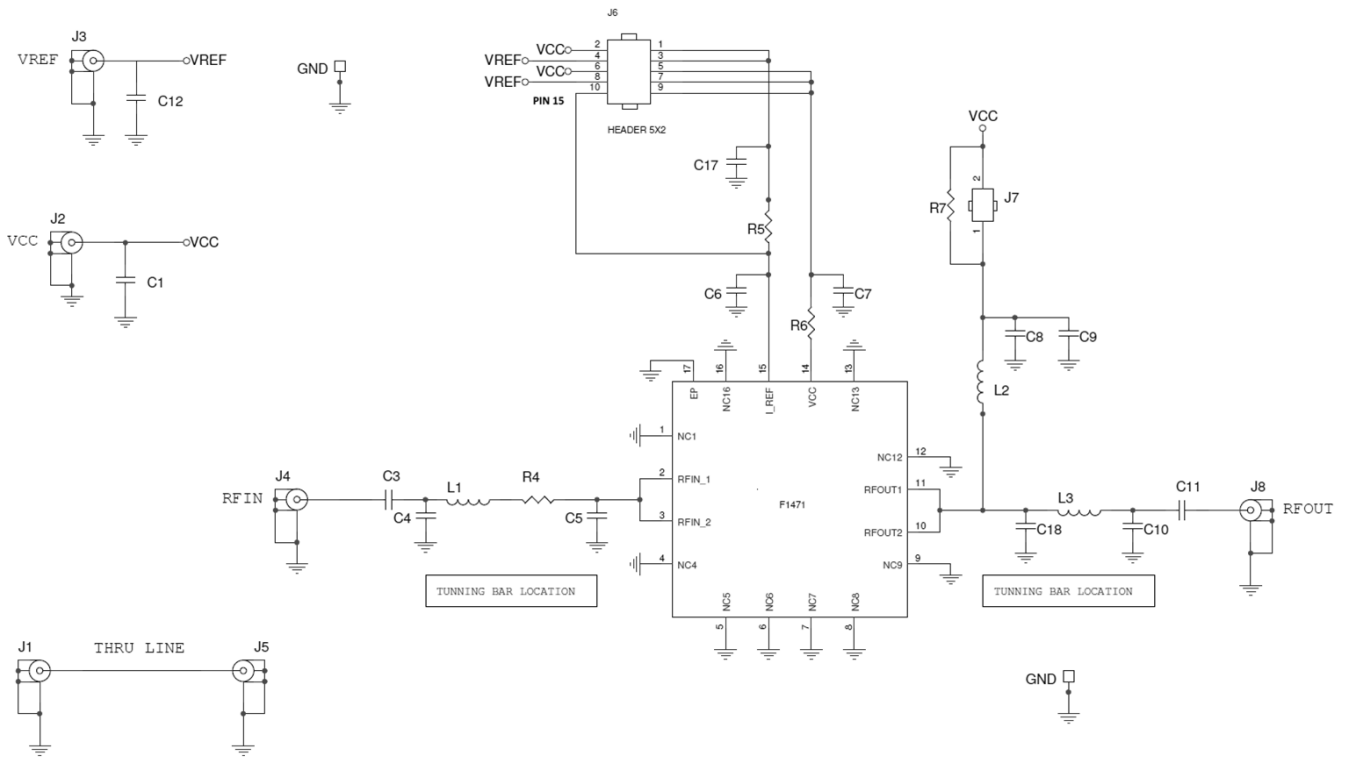

Figure 27. Electrical Schematic for the Evaluation Kit

7.2 Bill of Materials

Table 2. Evaluation Kit Bill of Material (BOM) – 2300MHz to 2900MHz Tune

Part Reference	Qty	Description	Manufacturer Part #	Manufacturer
C4	1	4.7nH \pm 0.1nH, 160mA, film Inductor (0402)	LQP15MN4N7B02	Murata
C5	1	3.1pF \pm 0.05pF, 50V, C0G Ceramic Capacitor (0402)	GJM1555C1H3R1WB01	Murata
C3, C6, C7, C8, C11	5	1000pF \pm 5%, 50V, C0G Ceramic Capacitor (0402)	GRM1555C1H102JA01	Murata
C1, C12	2	47uF \pm 20%, 10V, C0G Ceramic Capacitor (0805)	GRM21BR61A476ME15	Murata
C9	1	100nF \pm 10%, 50V, C0G Ceramic Capacitor (0402)	GRM1555C81H104KE14	Murata
C10	1	0.9pF \pm 0.05pF, 50V, C0G Ceramic Capacitor (0402)	GRM1555C1HR90W	Murata
C18	1	1.3pF \pm 0.05pF, 50V, C0G Ceramic Capacitor (0402)	GJM1555C1H1R3WB01	Murata
L1	1	1.2pF \pm 0.05pF, 50V, C0G Ceramic Capacitor (0402)	GRM1555C1H1R20WA01	Murata
L2	1	3.9nH \pm 2%, 250MHz, Ceramic Chip Inductor (0603)	0603CS-3N9XGE	Coilcraft
L3	1	1.2nH \pm 0.05nH, Inductor (0402)	LQP15MN1N2W	Murata
R4	1	5.1 Ω \pm 1% 0.063W, 1/16W Resistor (0402)	CRCW04025R10FKED	Vishay Dale
R5	1	Vref at 3.3V: 174 Ω \pm 0.5%, 0.063W, 1/16W Resistor (0402)	TNPW0402174RDEED	Vishay Dale
		Vref at 5V: 2.5k Ω \pm 0.1%, 0.063W, 1/16W Resistor (0402)	TNPW04022K52BEED	Vishay Dale
R6	1	0 Ω Jumper 0.063W, 1/16W Chip Resistor (0402)	CRCW04020000Z0ED	Vishay Dale
R7		DNP		
J2, J3, J4, J8	4	Edge Launch SMA (0.375-inch pitch ground, tab, 50 Ω)	142-0701-851	Emerson Johnson
J6	1	CONN HEADER VERT DBL 5x2 POS GOLD	961210-6404-AR	3M
J7	1	CONN HEADER VERT SGL 2x1 POS GOLD	961102-6404-AR	3M
EVB	1	F1471_Evkit_Solder_Rev.03		Renesas
Module	1	F1471YAA		Renesas

Table 3. Evaluation Kit Bill of Material (BOM) – 3300MHz to 3900MHz Tune

Part Reference	Qty	Description	Manufacturer Part #	Manufacturer
C4	1	5.6nH \pm 0.1nH, 160mA, film Inductor (0402)	LQP15MN5N6B02	Murata
C5	1	1.3pF \pm 0.05pF, 50V, C0G Ceramic Capacitor (0402)	GJM1555C1H1R3WB01	Murata
C3, C6, C7, C8, C11	5	1000pF \pm 5%, 50V, C0G Ceramic Capacitor (0402)	GRM1555C1H102JA01	Murata
C1, C12	2	47 μ F \pm 20%, 10V, C0G Ceramic Capacitor (0805)	GRM21BR61A476ME15	Murata
C9	1	100nF \pm 10%, 50V, C0G Ceramic Capacitor (0402)	GRM1555C81H104KE14	Murata
C10	1	DNI		
C18	1	1.2pF \pm 0.05pF, 50V, C0G Ceramic Capacitor (0402)	GJM1555C1H1R2WB01	Murata
L1	1	0.5pF \pm 0.05pF, 50V, C0G Ceramic Capacitor (0402)	GRM1555C1HR50WA01	Murata
L2	1	3.3nH \pm 2%, 250 MHz, Ceramic Chip Inductor (0603)	0603CS-3N3XGE	Coilcraft
L3, R6	2	0 Ω Jumper 0.063W, 1/16W Chip Resistor (0402)	CRCW04020000Z0ED	Vishay Dale
R4	1	1 Ω \pm 1% 0.063W, 1/16W Resistor (0402)	CRCW04021R00FKED	Vishay Dale
R5	1	Vref at 3.3V: 174 Ω \pm 0.5%, 0.063W, 1/16W Resistor (0402)	TNPW0402174RDEED	Vishay Dale
		Vref at 5V: 2.5k Ω \pm 0.1%, 0.063W, 1/16W Resistor (0402)	TNPW04022K52BEED	Vishay Dale
R7		DNP		
J2, J3, J4, J8	4	Edge Launch SMA (0.375 inch pitch ground, tab, 50 Ω)	142-0701-851	Emerson Johnson
J6	1	CONN HEADER VERT DBL 5x2 POS GOLD	961210-6404-AR	3M
J7	1	CONN HEADER VERT SGL 2x1 POS GOLD	961102-6404-AR	3M
EVB	1	F1471_Evkit_Solder_Rev.03		Renesas
Module	1	F1471YAA		Renesas

Table 4. Evaluation Kit Bill of Material (BOM) – 3800MHz to 4200MHz Tune

Part Reference	Qty	Description	Manufacturer Part #	Manufacturer
C4	1	5.1nH \pm 0.1nH, 160mA, film Inductor (0402)	LQP15MN5N1B02	Murata
C5	1	1.2pF \pm 0.05pF, 50V, C0G Ceramic Capacitor (0402)	GJM1555C1H1R2WB01	Murata
C3, C6, C7, C8, C11	5	1000pF \pm 5%, 50V, C0G Ceramic Capacitor (0402)	GRM1555C1H102JA01	Murata
C1, C12	2	47uF \pm 20%, 10V, C0G Ceramic Capacitor (0805)	GRM21BR61A476ME15	Murata
C9	1	100nF \pm 10%, 50V, C0G Ceramic Capacitor (0402)	GRM1555C81H104KE14	Murata
C10	1	DNI		
C18	1	1.0pF \pm 0.05pF, 50V, C0G Ceramic Capacitor (0402)	GJM1555C1H1R0WB01	Murata
L1, L3, R6	3	0 Ω Jumper 0.063W, 1/16W Chip Resistor (0402)	CRCW04020000Z0ED	Vishay Dale
L2	1	3.3nH \pm 2%, 250MHz, Ceramic Chip Inductor (0603)	0603CS-3N3XGE	Coilcraft
R4	1	0.5pF \pm 0.05, 50V, COG Ceramic Capacitor (0402)	GRMC1HR50WA01	Murata
R5	1	Vref at 3.3V: 174 Ω \pm 0.5%, 0.063W, 1/16W Resistor (0402)	TNPW0402174RDEED	Vishay Dale
		Vref at 5V: 2.5k Ω \pm 0.1%, 0.063W, 1/16W Resistor (0402)	TNPW04022K52BEED	Vishay Dale
R7		DNP		
J2, J3, J4, J8	4	Edge Launch SMA (0.375-inch pitch ground, tab, 50 Ω)	142-0701-851	Emerson Johnson
J6	1	CONN HEADER VERT DBL 5x2 POS GOLD	961210-6404-AR	3M
J7	1	CONN HEADER VERT SGL 2x1 POS GOLD	961102-6404-AR	3M
EVB	1	F1471_Evkit_Solder_Rev.03		Renesas
Module	1	F1471YAA		Renesas

7.3 Evaluation Kit Operation

7.3.1. Power Supply Setup

Set up a power supply in the voltage range of 4.75V to 5.25V with the power supply output disabled. The voltage is applied using the following connection (see Figure 26):

- Directly to the J2 SMA connector

Set up a control supply of either 3.3V or 5V (Use the correct value of resistance (R5) based on the applied control voltage as indicated per the BOM). The voltage is applied using the following connection (see Figure 26):

- Directly to the J3 SMA connector

7.3.2. Shunt Jumper Setup

- J7 Header Pins

- Always place the Shunt Jumper to bias the amplifier output (see Evaluation Schematic in Figure 27).

- J6 Header Pins

- J6 Header pins provide the V_{CC} and V_{REF} voltages to the DUT.
 - Always place a shunt jumper on pins 5 and 6 to provide the supplied V_{CC} to the DUT.
 - Place a shunt jumper on pins 3 and 4. In this configuration, V_{REF} is set independent to the supply voltage, V_{CC} .
 - Place a shunt jumper on pins 1 and 2. In this configuration, V_{REF} is set to the same level as the supply voltage, V_{CC} .
- Only place jumpers on Pins 3 and 4 or Pins 1 and 2 at any given time.
Important: Do not place jumpers on all four pins (1, 2, 3, and 4) simultaneously.

7.3.3. Power-On Procedure

1. Set up the voltage supplies, and Evaluation Board as described in the Power Supply Setup section.
2. Enable the V_{CC} supply.
3. Enable the V_{REF} supply.

7.3.4. Power-Off Procedure

Disable the V_{REF} supply and then disable the V_{CC} power supply.

8. Package Outline Drawings

The package outline drawings are located at the end of this document and are accessible from the Renesas website (see package links in Ordering Information). The package information is the most current data available and is subject to change without revision of this document.

9. Ordering Information

Part Number	Package	MSL Rating	Carrier Type	Temperature Range
F1471NTGI	3 × 3 × 0.75 mm 16-VFQFPN	1	Tray	-40° to +115°C
F1471NTGI8	3 × 3 × 0.75 mm 16-VFQFPN	1	Reel	-40° to +115°C
F1471EVB-0P9	Evaluation Board 700MHz – 1100MHz Tune			
F1471EVB-2P1	Evaluation Board 1700MHz – 2300MHz Tune			
F1471EVB-2P6	Evaluation Board 2300MHz – 2900MHz Tune			
F1471EVB-3P6	Evaluation Board 3300MHz – 3900MHz Tune			
F1471EVB-4P0	Evaluation Board 3800MHz – 4200MHz Tune			

10. Marking Diagram

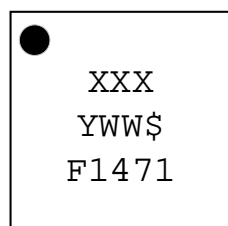

- “XXX” denotes the last 3 digits of the assembly lot number
- “Y” denotes the last digit of the year
- “WW” denotes the work week
- “\$” denotes the mark location code
- F1471 is the product name

11. Revision History

Revision	Revision Date	Description of Change
1.1	Jun.24.21	<ul style="list-style-type: none"> • Added Ordering Information for 0.9GHz and 2.1GHz Tune evaluation boards • Completed other minor changes
1.0	Oct.16.20	Initial release.

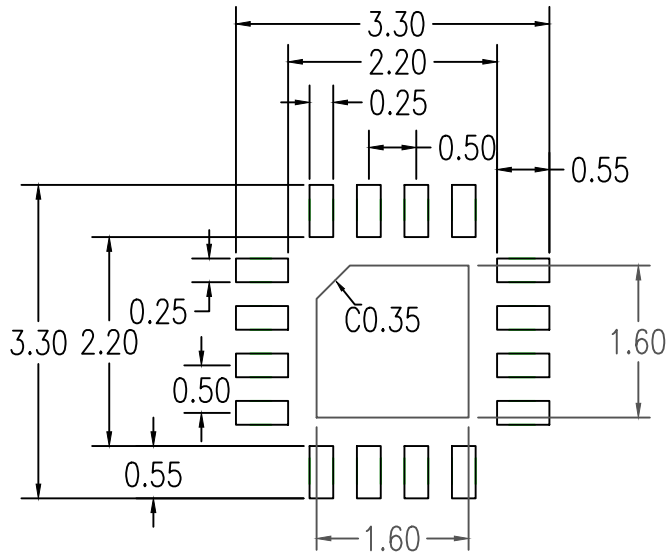

RECOMMENDED LAND PATTERN DIMENSION

NOTES:

1. ALL DIMENSION ARE IN MM. ANGLES IN DEGREES.
2. TOP DOWN VIEW. AS VIEWED ON PCB.
3. LAND PATTERN RECOMMENDATION PER IPC-7351B GENERIC REQUIREMENT FOR SURFACE MOUNT DESIGN AND LAND PATTERN.

Package Revision History		
Date Created	Rev No.	Description
July 8, 2019	Rev 03	Correct Typo Error Minimum
Sept 5, 2018	Rev 02	Add "K" Value 0.20 Minimum

IMPORTANT NOTICE AND DISCLAIMER

RENESAS ELECTRONICS CORPORATION AND ITS SUBSIDIARIES (“RENESAS”) PROVIDES TECHNICAL SPECIFICATIONS AND RELIABILITY DATA (INCLUDING DATASHEETS), DESIGN RESOURCES (INCLUDING REFERENCE DESIGNS), APPLICATION OR OTHER DESIGN ADVICE, WEB TOOLS, SAFETY INFORMATION, AND OTHER RESOURCES “AS IS” AND WITH ALL FAULTS, AND DISCLAIMS ALL WARRANTIES, EXPRESS OR IMPLIED, INCLUDING, WITHOUT LIMITATION, ANY IMPLIED WARRANTIES OF MERCHANTABILITY, FITNESS FOR A PARTICULAR PURPOSE, OR NON-INFRINGEMENT OF THIRD PARTY INTELLECTUAL PROPERTY RIGHTS.

These resources are intended for developers skilled in the art designing with Renesas products. You are solely responsible for (1) selecting the appropriate products for your application, (2) designing, validating, and testing your application, and (3) ensuring your application meets applicable standards, and any other safety, security, or other requirements. These resources are subject to change without notice. Renesas grants you permission to use these resources only for development of an application that uses Renesas products. Other reproduction or use of these resources is strictly prohibited. No license is granted to any other Renesas intellectual property or to any third party intellectual property. Renesas disclaims responsibility for, and you will fully indemnify Renesas and its representatives against, any claims, damages, costs, losses, or liabilities arising out of your use of these resources. Renesas' products are provided only subject to Renesas' Terms and Conditions of Sale or other applicable terms agreed to in writing. No use of any Renesas resources expands or otherwise alters any applicable warranties or warranty disclaimers for these products.

(Rev.1.0 Mar 2020)

Corporate Headquarters

TOYOSU FORESIA, 3-2-24 Toyosu,
Koto-ku, Tokyo 135-0061, Japan
www.renesas.com

Contact Information

For further information on a product, technology, the most up-to-date version of a document, or your nearest sales office, please visit:
www.renesas.com/contact/

Trademarks

Renesas and the Renesas logo are trademarks of Renesas Electronics Corporation. All trademarks and registered trademarks are the property of their respective owners.