



Heterojunction Bipolar Transistor Technology (InGaP HBT)

Broadband High Linearity Amplifier

The MMG3015NT1 is a general purpose amplifier that is internally input and output matched. It is designed for a broad range of Class A, small-signal, high linearity, general purpose applications. It is suitable for applications with frequencies from 0 to 6000 MHz such as cellular, PCS, BWA, WLL, PHS, CATV, VHF, UHF, UMTS and general small-signal RF.

Features

- Frequency: 0-6000 MHz
- P1dB: 20.5 dBm @ 900 MHz
- Small-Signal Gain: 15.5 dB @ 900 MHz
- Third Order Output Intercept Point: 36 dBm @ 900 MHz
- Single 5 V Supply
- Active Bias Control
- Internally Matched to 50 Ohms
- Cost-effective SOT-89 Surface Mount Plastic Package
- In Tape and Reel. T1 Suffix = 1,000 Units, 12 mm Tape Width, 7-inch Reel.

MMG3015NT1

**0-6000 MHz, 15.5 dB
 20.5 dBm
 InGaP HBT GPA**



Table 1. Typical Performance (1)

Characteristic	Symbol	900 MHz	2140 MHz	3500 MHz	Unit
Small-Signal Gain (S21)	G _p	15.5	14.5	12.5	dB
Input Return Loss (S11)	IRL	-15	-19	-19	dB
Output Return Loss (S22)	ORL	-13	-9	-7	dB
Power Output @1dB Compression	P1dB	20.5	20.5	18.5	dBm
Third Order Output Intercept Point	OIP3	36	33.5	30.5	dBm

1. V_{CC} = 5 Vdc, T_A = 25°C, 50 ohm system.

Table 2. Maximum Ratings

Rating	Symbol	Value	Unit
Supply Voltage	V _{CC}	7	V
Supply Current	I _{CC}	300	mA
RF Input Power	P _{in}	12	dBm
Storage Temperature Range	T _{stg}	-65 to +150	°C
Junction Temperature	T _J	175	°C

Table 3. Thermal Characteristics

Characteristic	Symbol	Value (2)	Unit
Thermal Resistance, Junction to Case Case Temperature 95°C, 5 Vdc, 95 mA, no RF applied	R _{θJC}	41.5	°C/W

2. Refer to AN1955, *Thermal Measurement Methodology of RF Power Amplifiers*. Go to <http://www.freescale.com/rf>.
 Select Documentation/Application Notes - AN1955.

Table 4. Electrical Characteristics ($V_{CC} = 5$ Vdc, 900 MHz, $T_A = 25^\circ\text{C}$, 50 ohm system, in Freescale Application Circuit)

Characteristic	Symbol	Min	Typ	Max	Unit
Small-Signal Gain (S21)	G_p	14	15.5	—	dB
Input Return Loss (S11)	IRL	—	-15	—	dB
Output Return Loss (S22)	ORL	—	-13	—	dB
Power Output @ 1dB Compression	P1dB	—	20.5	—	dBm
Third Order Output Intercept Point	OIP3	—	36	—	dBm
Noise Figure	NF	—	5.6	—	dB
Supply Current	I_{CC}	80	95	120	mA
Supply Voltage	V_{CC}	—	5	—	V

Table 5. Functional Pin Description

Pin Number	Pin Function
1	RF_{in}
2	Ground
3	RF_{out}/DC Supply

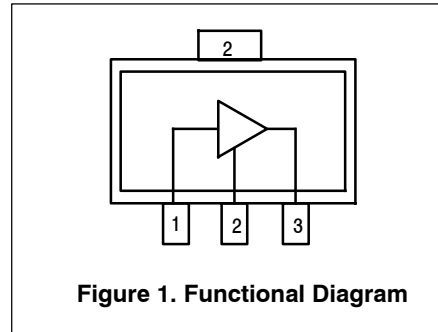
**Table 6. ESD Protection Characteristics**

Test Methodology	Class
Human Body Model (per JESD 22-A114)	1C
Machine Model (per EIA/JESD 22-A115)	A
Charge Device Model (per JESD 22-C101)	IV

Table 7. Moisture Sensitivity Level

Test Methodology	Rating	Package Peak Temperature	Unit
Per JESD 22-A113, IPC/JEDEC J-STD-020	1	260	$^\circ\text{C}$

50 OHM TYPICAL CHARACTERISTICS

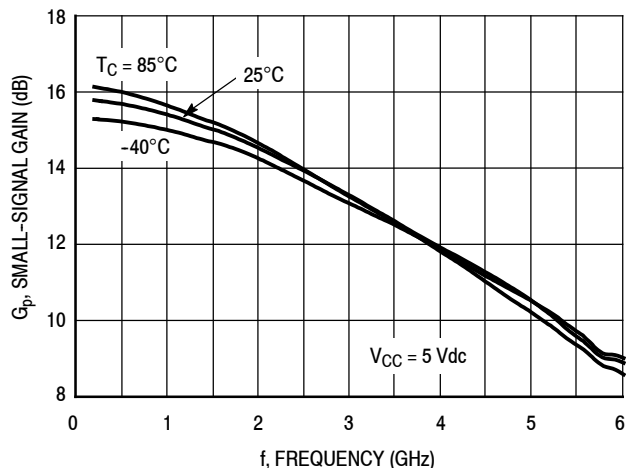

Figure 2. Small-Signal Gain (S21) versus Frequency

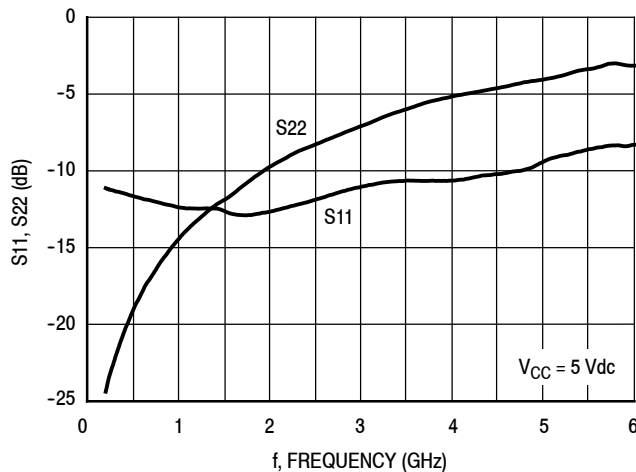

Figure 3. Input/Output Loss versus Frequency

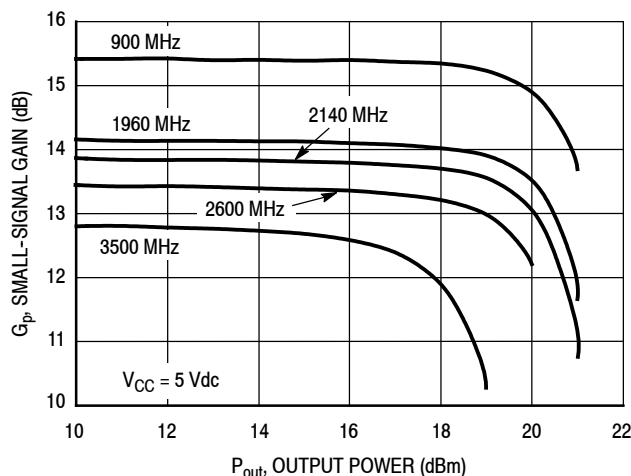

Figure 4. Small-Signal Gain versus Output Power

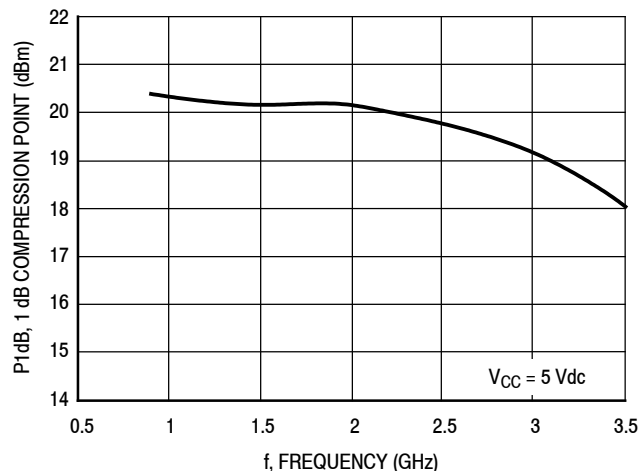

Figure 5. P1dB versus Frequency

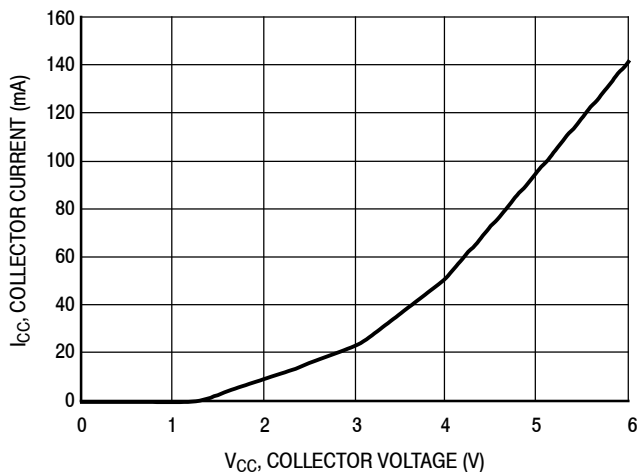

Figure 6. Collector Current versus Collector Voltage

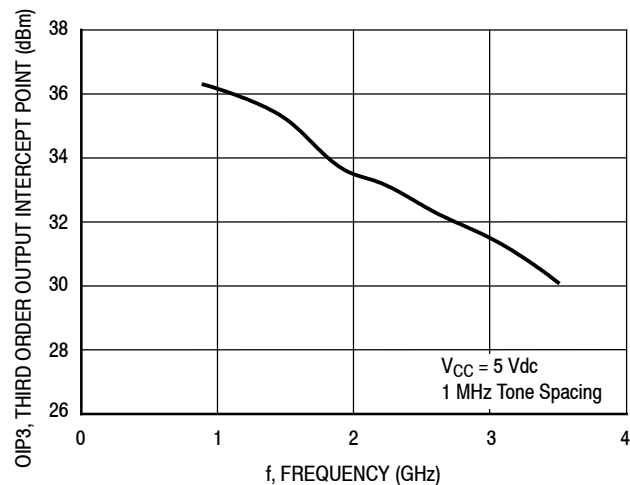

Figure 7. Third Order Output Intercept Point versus Frequency

50 OHM TYPICAL CHARACTERISTICS

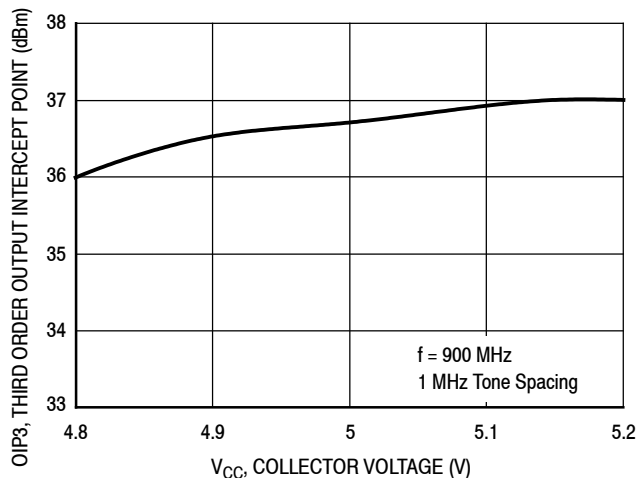

Figure 8. Third Order Output Intercept Point versus Collector Voltage

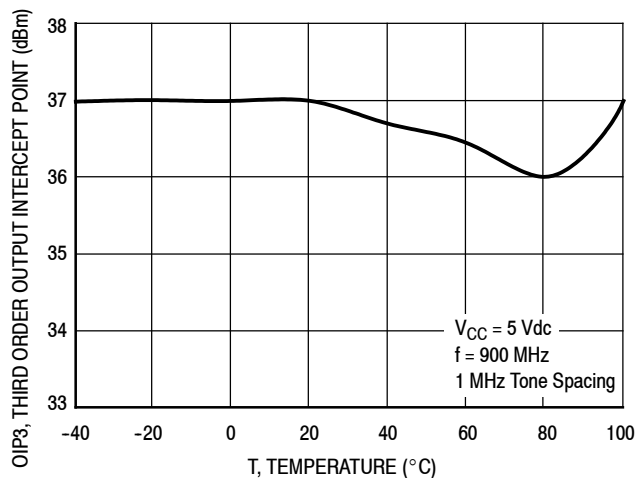

Figure 9. Third Order Output Intercept Point versus Case Temperature

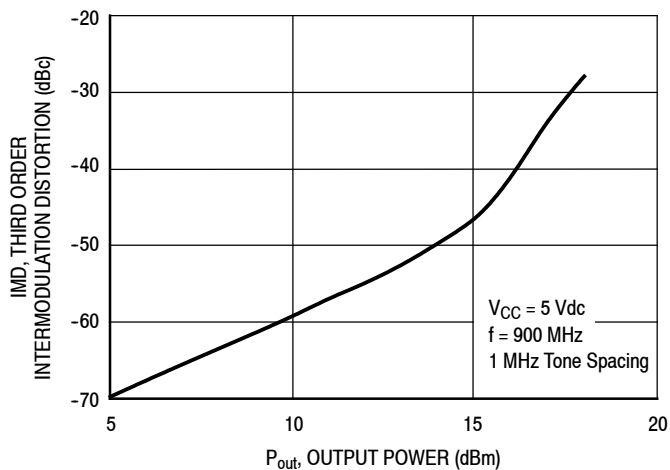

Figure 10. Third Order Intermodulation Distortion versus Output Power

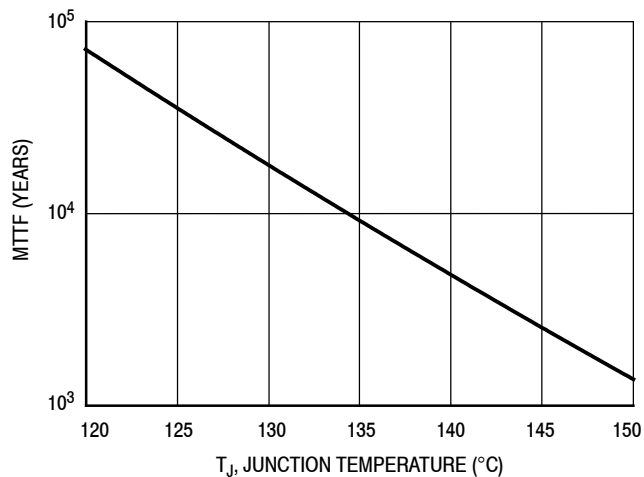

Figure 11. MTTF versus Junction Temperature
NOTE: The MTTF is calculated with $V_{CC} = 5 \text{ Vdc}$, $I_{CC} = 95 \text{ mA}$

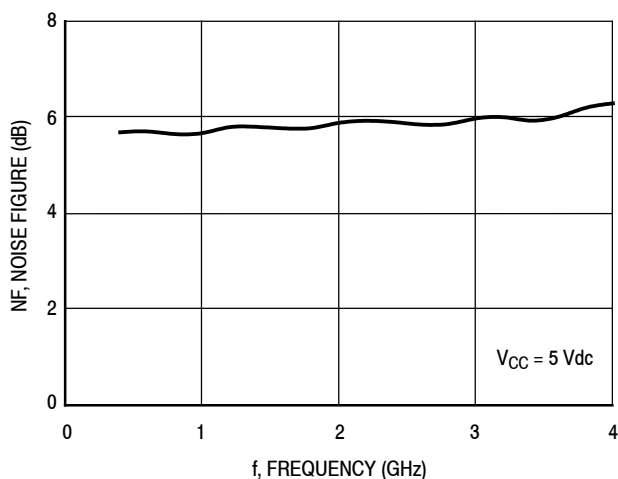

Figure 12. Noise Figure versus Frequency

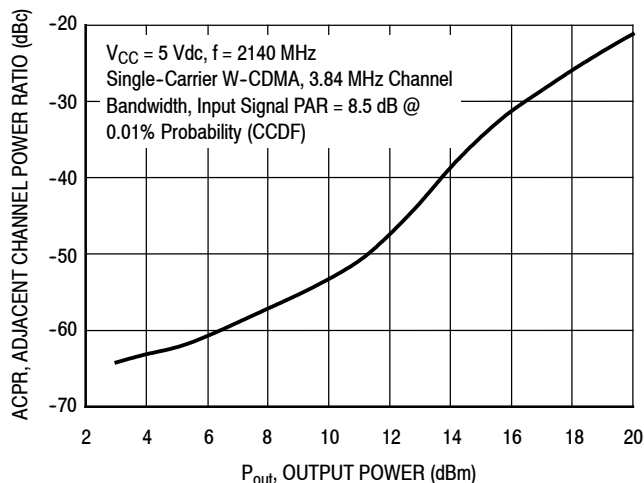

Figure 13. Single-Carrier W-CDMA Adjacent Channel Power Ratio versus Output Power

50 OHM APPLICATION CIRCUIT: 40-800 MHz

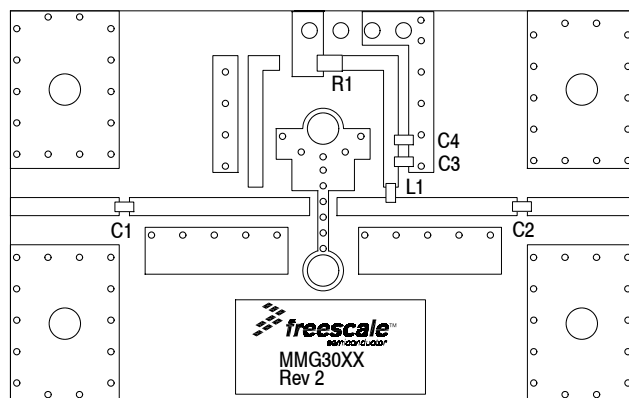
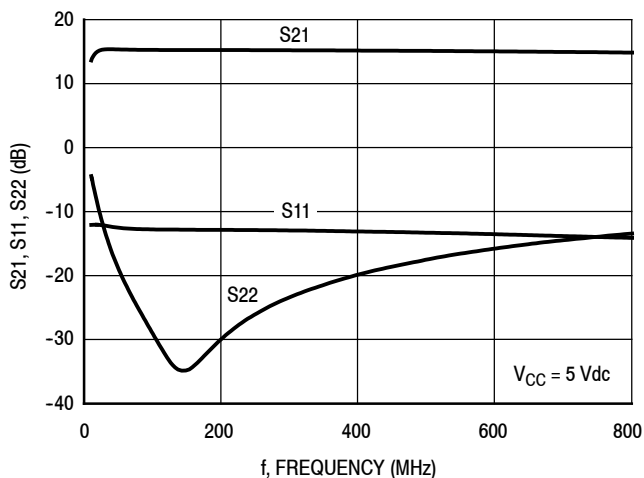
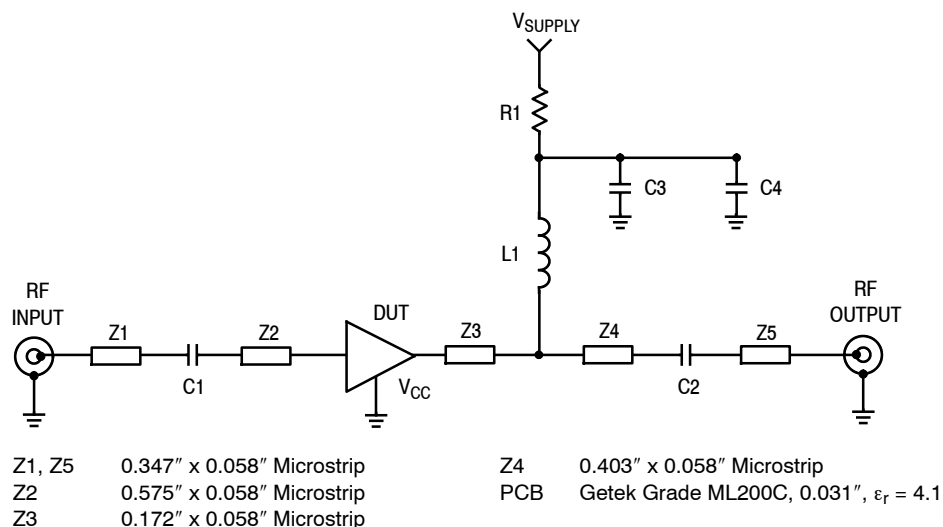

Table 8. 50 Ohm Test Circuit Component Designations and Values

Part	Description	Part Number	Manufacturer
C1, C2	0.01 μ F Chip Capacitors	C0603C103J5RAC	Kemet
C3	0.1 μ F Chip Capacitor	C0603C104J5RAC	Kemet
C4	1 μ F Chip Capacitor	C0603C105J5RAC	Kemet
L1	470 nH Chip Inductor	BK2125HM471-T	Taiyo Yuden
R1	0 Ω , 1/10 W Chip Resistor	CRCW06030000FKEA	Vishay

50 OHM APPLICATION CIRCUIT: 800-3600 MHz

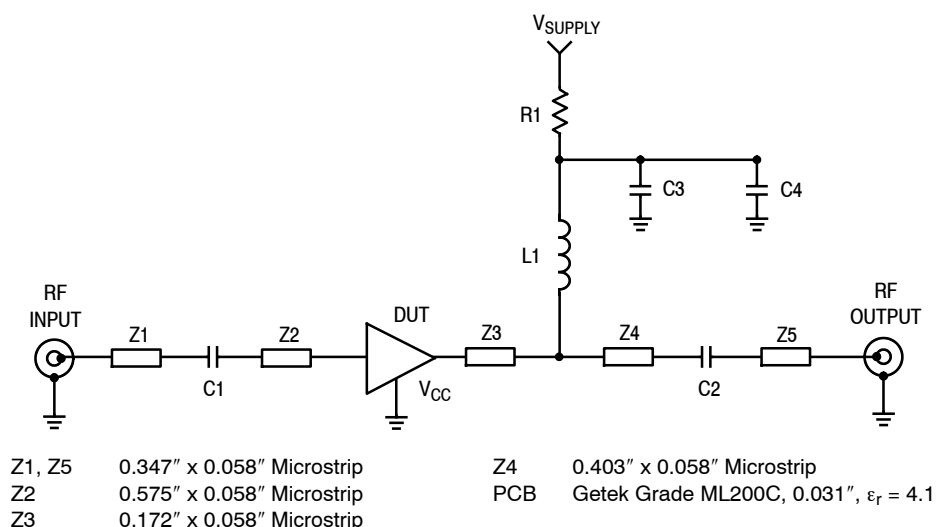

Figure 17. 50 Ohm Test Circuit Schematic

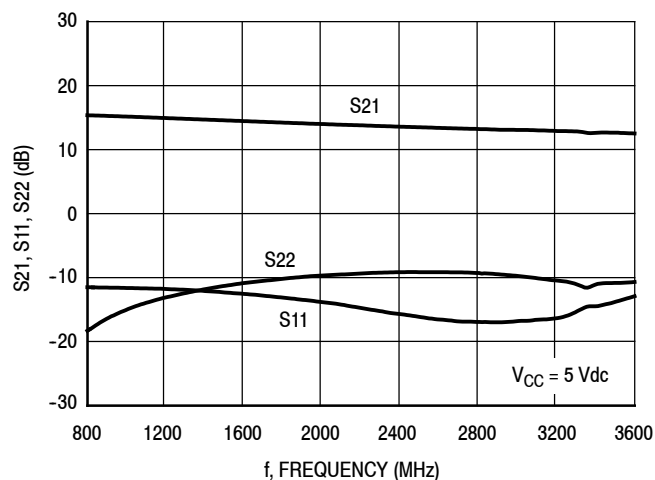

Figure 18. S21, S11 and S22 versus Frequency

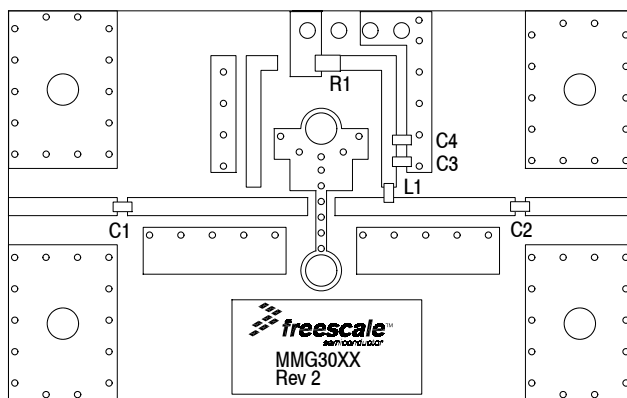

Figure 19. 50 Ohm Test Circuit Component Layout

Table 9. 50 Ohm Test Circuit Component Designations and Values

Part	Description	Part Number	Manufacturer
C1, C2	150 pF Chip Capacitors	C0603C151J5RAC	Kemet
C3	0.1 μ F Chip Capacitor	C0603C104J5RAC	Kemet
C4	1 μ F Chip Capacitor	C0603C105J5RAC	Kemet
L1	56 nH Chip Inductor	HK160856NJ-T	Taiyo Yuden
R1	0 Ω , 1/10 W Chip Resistor	CRCW06030000FKEA	Vishay

50 OHM TYPICAL CHARACTERISTICS

Table 10. Common Emitter S-Parameters ($V_{CC} = 5 \text{ Vdc}$, $T_A = 25^\circ\text{C}$, 50 Ohm System)

f MHz	S ₁₁		S ₂₁		S ₁₂		S ₂₂	
	S ₁₁	∠ φ	S ₂₁	∠ φ	S ₁₂	∠ φ	S ₂₂	∠ φ
200	0.28	174.23	6.17	171.48	0.08	-2.66	0.06	-43.26
250	0.28	172.92	6.16	169.36	0.08	-3.32	0.07	-50.81
300	0.27	171.92	6.15	167.25	0.08	-3.93	0.08	-56.75
350	0.27	170.57	6.14	165.15	0.08	-4.60	0.09	-62.45
400	0.27	169.49	6.12	163.07	0.08	-5.22	0.09	-67.13
450	0.26	168.53	6.11	160.97	0.08	-5.85	0.10	-71.09
500	0.26	167.16	6.10	158.87	0.08	-6.50	0.11	-74.88
550	0.26	165.92	6.08	156.78	0.08	-7.14	0.12	-77.99
600	0.26	164.77	6.06	154.73	0.08	-7.76	0.13	-81.75
650	0.26	163.38	6.05	152.65	0.08	-8.41	0.14	-85.06
700	0.25	162.57	6.03	150.58	0.08	-9.03	0.14	-88.16
750	0.25	161.36	6.01	148.53	0.08	-9.64	0.15	-91.28
800	0.25	160.35	5.99	146.50	0.08	-10.26	0.16	-93.96
850	0.25	159.29	5.97	144.45	0.08	-10.88	0.17	-96.90
900	0.25	158.03	5.95	142.41	0.08	-11.52	0.18	-99.99
950	0.24	157.14	5.93	140.38	0.08	-12.14	0.18	-102.70
1000	0.24	156.02	5.91	138.38	0.08	-12.78	0.19	-105.47
1050	0.24	154.89	5.88	136.37	0.08	-13.38	0.20	-108.27
1150	0.24	153.09	5.83	132.34	0.08	-14.64	0.21	-114.23
1200	0.24	152.30	5.80	130.37	0.08	-15.28	0.22	-117.17
1250	0.24	151.41	5.77	128.39	0.08	-15.94	0.22	-120.26
1300	0.24	150.63	5.75	126.41	0.08	-16.57	0.23	-123.42
1350	0.24	150.09	5.72	124.46	0.08	-17.17	0.24	-126.34
1400	0.24	149.52	5.69	122.50	0.08	-17.81	0.24	-129.61
1450	0.24	149.15	5.67	120.54	0.08	-18.46	0.25	-132.32
1500	0.23	148.71	5.65	118.61	0.08	-19.07	0.26	-134.63
1550	0.23	147.76	5.62	116.65	0.08	-19.73	0.26	-136.77
1600	0.23	146.51	5.60	114.72	0.08	-20.39	0.27	-138.90
1650	0.23	145.11	5.57	112.79	0.08	-21.04	0.28	-141.13
1900	0.23	138.41	5.41	103.23	0.08	-24.38	0.31	-152.46
2150	0.24	132.77	5.23	93.77	0.08	-27.79	0.35	-163.83
2400	0.25	128.41	5.05	84.48	0.08	-31.33	0.38	-175.54
2650	0.26	124.16	4.87	75.21	0.08	-35.09	0.40	172.45
2900	0.28	119.27	4.69	66.04	0.08	-39.03	0.43	161.50
2950	0.28	118.39	4.65	64.24	0.08	-39.86	0.44	159.35
3000	0.28	117.49	4.62	62.43	0.09	-40.65	0.44	157.23
3050	0.28	116.75	4.59	60.59	0.09	-41.48	0.45	154.83
3100	0.29	116.03	4.55	58.77	0.09	-42.33	0.46	152.37
3150	0.29	115.21	4.52	56.97	0.09	-43.16	0.46	150.02
3200	0.29	114.41	4.48	55.15	0.09	-44.01	0.47	147.68
3250	0.29	113.69	4.44	53.36	0.09	-44.83	0.48	145.58
3300	0.29	112.97	4.41	51.59	0.09	-45.67	0.48	143.48
3350	0.29	112.24	4.37	49.84	0.09	-46.48	0.49	141.43

(continued)

50 OHM TYPICAL CHARACTERISTICS

Table 10. Common Emitter S-Parameters ($V_{CC} = 5 \text{ Vdc}$, $T_A = 25^\circ\text{C}$, 50 Ohm System) (continued)

f MHz	S ₁₁		S ₂₁		S ₁₂		S ₂₂	
	S ₁₁	∠ φ	S ₂₁	∠ φ	S ₁₂	∠ φ	S ₂₂	∠ φ
3400	0.29	111.50	4.34	48.07	0.09	-47.31	0.49	139.46
3450	0.29	110.37	4.30	45.96	0.09	-48.32	0.50	137.08
3500	0.29	109.50	4.27	44.53	0.09	-49.01	0.50	135.57
3550	0.29	108.57	4.23	42.83	0.09	-49.82	0.51	133.81
3600	0.29	107.57	4.20	41.14	0.09	-50.64	0.52	132.08

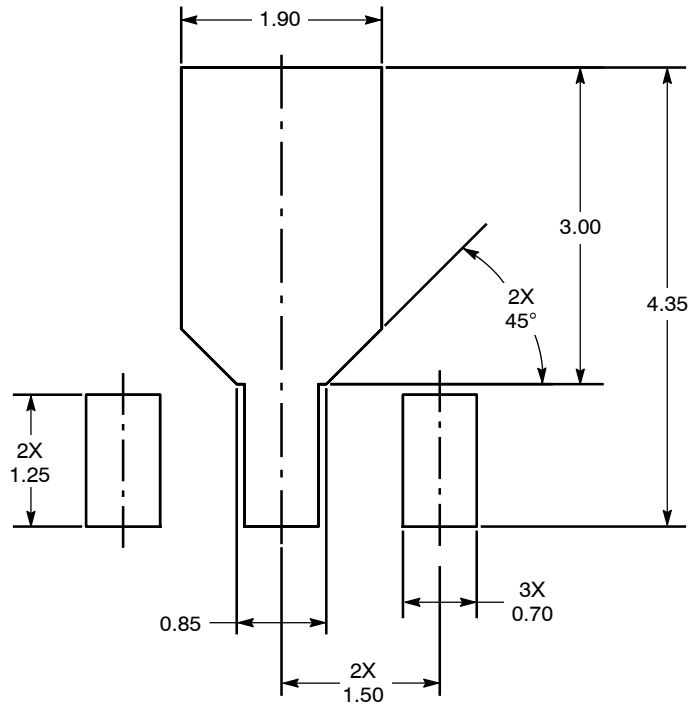

Figure 20. PCB Pad Layout for SOT-89A

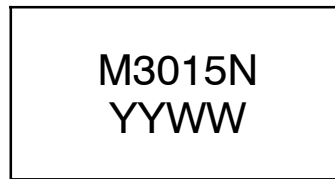
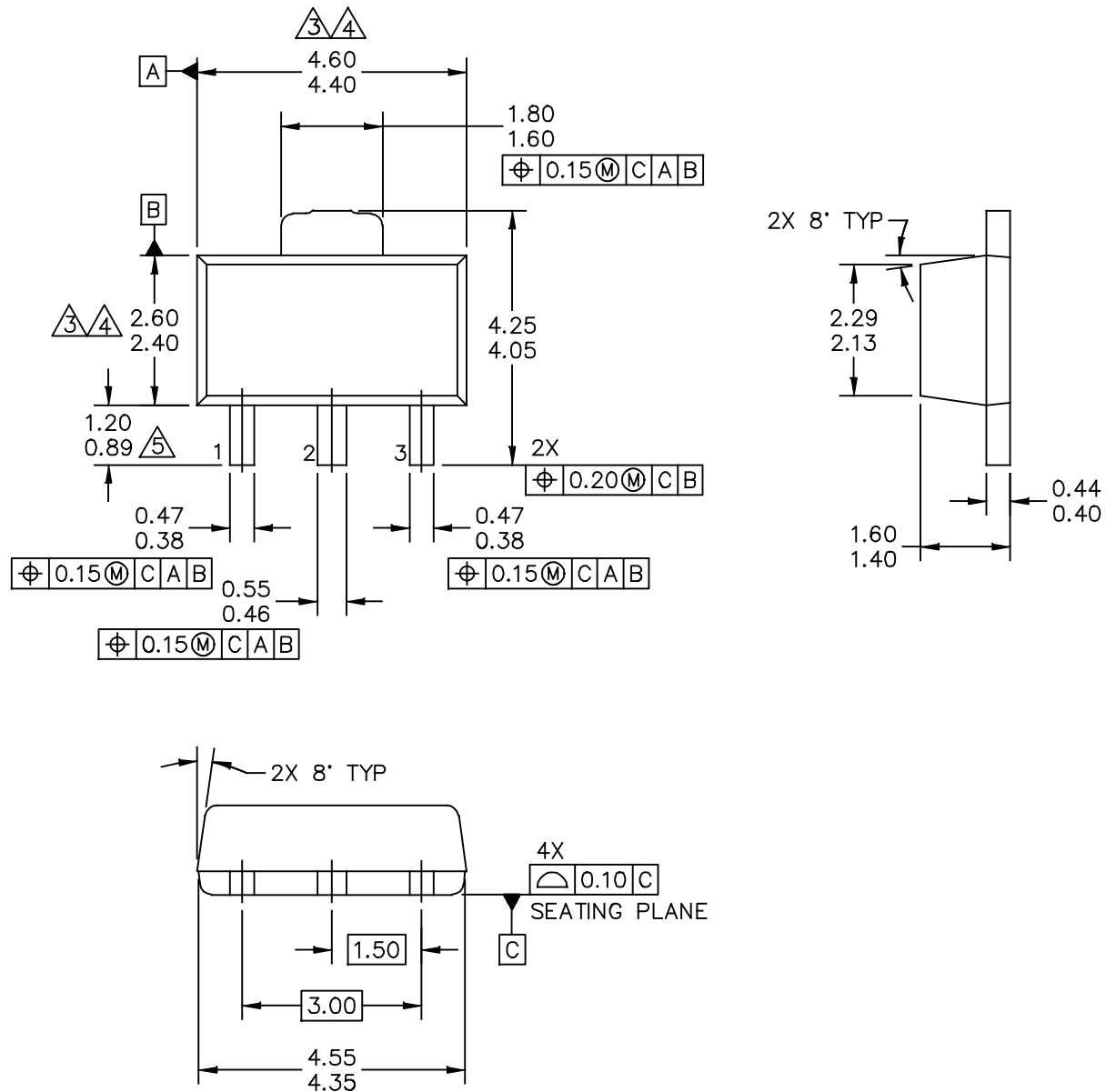
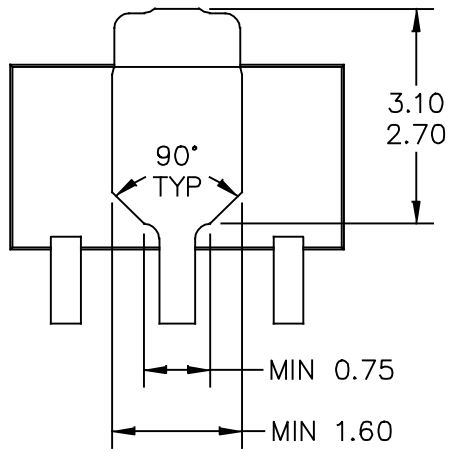

Figure 21. Product Marking

PACKAGE DIMENSIONS



© FREESCALE SEMICONDUCTOR, INC. ALL RIGHTS RESERVED.	MECHANICAL OUTLINE	PRINT VERSION NOT TO SCALE
TITLE: SOT-89A, 3 LEAD, 4.5 X 2.5 PKG, 1.5 MM PITCH	DOCUMENT NO: 98ASA00241D	REV: 0
	CASE NUMBER: 2142-01	15 JUL 2010
	STANDARD: NON-JEDEC	



BOTTOM VIEW

© FREESCALE SEMICONDUCTOR, INC. ALL RIGHTS RESERVED.	MECHANICAL OUTLINE	PRINT VERSION NOT TO SCALE	
TITLE: SOT-89A, 3 LEAD, 4.5 X 2.5 PKG, 1.5 MM PITCH	DOCUMENT NO: 98ASA00241D	REV: 0	
	CASE NUMBER: 2142-01	15 JUL 2010	
	STANDARD: NON-JEDEC		

NOTES:

1. DIMENSIONING AND TOLERANCING PER ASME Y14.5M – 1994.

2. ALL DIMENSIONS ARE IN MILLIMETERS.

3. DIMENSIONS DOES NOT INCLUDE MOLD FLASH. PROTRUSIONS OR GATE BURRS. MOLD FLASH, PROTRUSIONS OR GATE BURRS SHALL NOT EXCEED 0.5 MM PER END. DIMENSION DOES NOT INCLUDE INTERLEAD FLASH OR PROTRUSION. INTERLEAD FLASH OR PROTRUSION SHALL NOT EXCEED 0.5 MM PER SIDE.

4. DIMENSION ARE DETERMINED AT THE OUTMOST EXTREMES OF THE PLASTIC BODY EXCLUSIVE OF MOLD FLASH, TIE BAR BURRS, GATE BURRS AND INTERLEAD FLASH, BUT INCLUDING ANY MISMATCH BETWEEN THE TOP AND BOTTOM OF THE PLASTIC BODY.

5. TERMINAL NUMBERS ARE SHOWN FOR REFERENCE ONLY.

© FREESCALE SEMICONDUCTOR, INC. ALL RIGHTS RESERVED.	MECHANICAL OUTLINE	PRINT VERSION NOT TO SCALE	
TITLE: SOT-89A, 3 LEAD, 4.5 X 2.5 PKG, 1.5 MM PITCH	DOCUMENT NO: 98ASA00241D	REV: 0	
	CASE NUMBER: 2142-01	15 JUL 2010	
	STANDARD: NON-JEDEC		

PRODUCT DOCUMENTATION, SOFTWARE AND TOOLS

Refer to the following resources to aid your design process.

Application Notes

- AN1955: Thermal Measurement Methodology of RF Power Amplifiers
- AN3100: General Purpose Amplifier and MMIC Biasing

Software

- .s2p File

Development Tools

- Printed Circuit Boards

For Software and Tools, do a Part Number search at <http://www.freescale.com>, and select the “Part Number” link. Go to Software & Tools on the part’s Product Summary page to download the respective tool.

FAILURE ANALYSIS

At this time, because of the physical characteristics of the part, failure analysis is limited to electrical signature analysis. In cases where Freescale is contractually obligated to perform failure analysis (FA) services, full FA may be performed by third party vendors with moderate success. For updates contact your local Freescale Sales Office.

REVISION HISTORY

The following table summarizes revisions to this document.

Revision	Date	Description
0	Aug. 2007	<ul style="list-style-type: none">• Initial Release of Data Sheet
1	Apr. 2008	<ul style="list-style-type: none">• Removed Footnote 2, Continuous voltage and current applied to device, from Table 2, Maximum Ratings, p. 1• Corrected Fig. 13, Single-Carrier W-CDMA Adjacent Channel Power Ratio versus Output Power y-axis (ACPR) unit of measure to dBc, p. 5• Updated Part Numbers in Tables 8, 9, Component Designations and Values, to latest RoHS compliant part numbers, pp. 6, 7
2	Feb. 2012	<ul style="list-style-type: none">• Corrected temperature at which Θ_{JC} is measured from 25°C to 95°C and added “no RF applied” to Thermal Characteristics table to indicate that thermal characterization is performed under DC test with no RF signal applied, p. 1• Table 6, ESD Protection Characteristics, removed the word “Minimum” after the ESD class rating. ESD ratings are characterized during new product development but are not 100% tested during production. ESD ratings provided in the data sheet are intended to be used as a guideline when handling ESD sensitive devices, p. 3• Removed I_{CC} bias callout from applicable graphs and Table 10, Common Emitter S-Parameters heading as bias is not a controlled value, pp. 4-9• Added .s2p File availability to Product Software and Printed Circuit Boards to Development Tools, p. 14
3	Sept. 2012	<ul style="list-style-type: none">• Replaced the PCB Pad Layout drawing, the package isometric and mechanical outline for Case 1514-02 (SOT-89) with Case 2142-01 (SOT-89) as a result of the device transfer from a Freescale wafer fab to an external GaAs wafer fab and new assembly site. The new assembly and test site’s SOT-89 package has slight dimensional differences, pp. 1, 10-13. Refer to PCN13337, <i>GaAs Fab Transfer</i>.• Added Fig. 21, Product Marking, p. 10
4	Sept. 2014	<ul style="list-style-type: none">• Table 2, Maximum Ratings: updated Junction Temperature from 150°C to 175°C to reflect recent test results of the device, p. 1• Added Failure Analysis information, p. 13

How to Reach Us:

Home Page:
freescale.com

Web Support:
freescale.com/support

Information in this document is provided solely to enable system and software implementers to use Freescale products. There are no express or implied copyright licenses granted hereunder to design or fabricate any integrated circuits based on the information in this document.

Freescale reserves the right to make changes without further notice to any products herein. Freescale makes no warranty, representation, or guarantee regarding the suitability of its products for any particular purpose, nor does Freescale assume any liability arising out of the application or use of any product or circuit, and specifically disclaims any and all liability, including without limitation consequential or incidental damages. "Typical" parameters that may be provided in Freescale data sheets and/or specifications can and do vary in different applications, and actual performance may vary over time. All operating parameters, including "typicals," must be validated for each customer application by customer's technical experts. Freescale does not convey any license under its patent rights nor the rights of others. Freescale sells products pursuant to standard terms and conditions of sale, which can be found at the following address: freescale.com/SalesTermsandConditions.

Freescale and the Freescale logo are trademarks of Freescale Semiconductor, Inc., Reg. U.S. Pat. & Tm. Off. All other product or service names are the property of their respective owners.

© 2007–2008, 2012, 2014 Freescale Semiconductor, Inc.

