

MOSFET– N & P-Channel, POWERTRENCH® 20 V



ON Semiconductor®

www.onsemi.com

FDG6332C

General Description

The N & P-Channel MOSFETs are produced using ON Semiconductor's advanced POWERTRENCH process that has been especially tailored to minimize on-state resistance and yet maintain superior switching performance.

These devices have been designed to offer exceptional power dissipation in a very small footprint for applications where the bigger more expensive TSSOP-8 and SSOP-6 packages are impractical.

Features

- $Q1$ 0.7 A, 20 V
 - ◆ $R_{DS(ON)} = 300 \text{ m}\Omega @ V_{GS} = 4.5 \text{ V}$
 - ◆ $R_{DS(ON)} = 400 \text{ m}\Omega @ V_{GS} = 2.5 \text{ V}$
- $Q2$ -0.6 A, -20 V
 - ◆ $R_{DS(ON)} = 420 \text{ m}\Omega @ V_{GS} = -4.5 \text{ V}$
 - ◆ $R_{DS(ON)} = 630 \text{ m}\Omega @ V_{GS} = -2.5 \text{ V}$
- Low Gate Charge
- High Performance Trench Technology for Extremely Low $R_{DS(ON)}$
- SC70-6 Package: Small Footprint (51% Smaller than SSOT-6); Low Profile (1 mm Thick)
- These Devices are Pb-Free and are RoHS Compliant

Applications

- DC/DC Converter
- Load Switch
- LCD Display Inverter

ABSOLUTE MAXIMUM RATINGS ($T_A = 25^\circ\text{C}$ unless otherwise noted)

Symbol	Parameter	Q1	Q2	Units	
V_{DSS}	Drain-Source Voltage	20	-20	V	
V_{GSS}	Gate-Source Voltage	± 12	± 12	V	
I_D	Drain Current	Continuous (Note 1)	0.7	-0.6	A
		Pulsed	2.1	-2	
P_D	Power Dissipation for Single Operation (Note 1)	0.3		W	
T_J, T_{STG}	Operating and Storage Junction Temperature Range	-55 to 150		$^\circ\text{C}$	

Stresses exceeding those listed in the Maximum Ratings table may damage the device. If any of these limits are exceeded, device functionality should not be assumed, damage may occur and reliability may be affected.

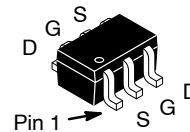

SC-88/SC70-6/SOT-363
CASE 419B-02

MARKING DIAGRAM

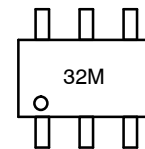

32 = Specific Device Code
M = Assembly Operation Month

PIN CONNECTIONS

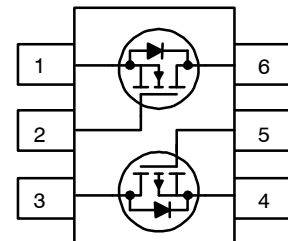

Complementary

ORDERING INFORMATION

See detailed ordering and shipping information on page 2 of this data sheet.

FDG6332C

THERMAL CHARACTERISTICS

Symbol	Parameter	Ratings	Unit
$R_{\theta JA}$	Thermal Resistance, Junction-to-Ambient (Note 1)	415	$^{\circ}\text{C}/\text{W}$

1. $R_{\theta JA}$ is the sum of the junction-to-case and case-to-ambient thermal resistance where the case thermal reference is defined as the solder mounting surface of the drain pins. $R_{\theta JC}$ is guaranteed by design while $R_{\theta CA}$ is determined by the user's board design. $R_{\theta JA} = 415^{\circ}\text{C}/\text{W}$ on minimum pad mounting on FR-4 board in still air.

ORDERING INFORMATION

Device Marking	Device	Reel Size	Tape Width	Shipping†
32	FDG6332C	7"	8 mm	3000 / Tape & Reel

†For information on tape and reel specifications, including part orientation and tape sizes, please refer to our Tape and Reel Packaging Specifications Brochure, BRD8011/D.

ELECTRICAL CHARACTERISTICS ($T_A = 25^{\circ}\text{C}$ unless otherwise noted)

Symbol	Parameter	Test Conditions	Min	Typ	Max	Unit
--------	-----------	-----------------	-----	-----	-----	------

OFF CHARACTERISTICS

BV_{DSS}	Drain-Source Breakdown Voltage	Q1	$V_{GS} = 0\text{ V}, I_D = 250\ \mu\text{A}$	20	-	-	V
		Q2	$V_{GS} = 0\text{ V}, I_D = -250\ \mu\text{A}$	-20	-	-	
$\Delta BV_{DSS} / \Delta T_J$	Breakdown Voltage Temperature Coefficient	Q1	$I_D = 250\ \mu\text{A}$, Referenced to 25°C	-	14	-	$\text{mV}/^{\circ}\text{C}$
		Q2	$I_D = -250\ \mu\text{A}$, Referenced to 25°C	-	-14	-	
I_{DSS}	Zero Gate Voltage Drain Current	Q1	$V_{DS} = 16\text{ V}, V_{GS} = 0\text{ V}$	-	-	1	μA
		Q2	$V_{DS} = -16\text{ V}, V_{GS} = 0\text{ V}$	-	-	-1	
I_{GSSF} / I_{GSSR}	Gate-Body Leakage, Forward	$V_{DS} = \pm 12\text{ V}, V_{GS} = 0\text{ V}$		-	-	± 100	nA
I_{GSSF} / I_{GSSR}	Gate-Body Leakage, Reverse	$V_{GS} = \pm 12\text{ V}, V_{DS} = 0\text{ V}$		-	-	± 100	nA

ON CHARACTERISTICS (Note 2)

$V_{GS(th)}$	Gate Threshold Voltage	Q1	$V_{DS} = V_{GS}, I_D = 250\ \mu\text{A}$	0.6	1.1	1.5	V
		Q2	$V_{DS} = V_{GS}, I_D = -250\ \mu\text{A}$	-0.6	-1.2	-1.5	
$\Delta V_{GS(th)} / \Delta T_J$	Gate Threshold Voltage Temperature Coefficient	Q1	$I_D = 250\ \mu\text{A}$, Referenced to 25°C	-	-2.8	-	$\text{mV}/^{\circ}\text{C}$
		Q2	$I_D = -250\ \mu\text{A}$, Referenced to 25°C	-	3	-	
$R_{DS(on)}$	Static Drain-Source On-Resistance	Q1	$V_{GS} = 4.5\text{ V}, I_D = 0.7\text{ A}$	-	180	300	m Ω
			$V_{GS} = 2.5\text{ V}, I_D = 0.6\text{ A}$	-	293	400	
			$V_{GS} = 4.5\text{ V}, I_D = 0.7\text{ A}, T_J = 125^{\circ}\text{C}$	-	247	442	
		Q2	$V_{GS} = -4.5\text{ V}, I_D = -0.6\text{ A}$	-	300	420	
			$V_{GS} = -2.5\text{ V}, I_D = -0.5\text{ A}$	-	470	630	
			$V_{GS} = -4.5\text{ V}, I_D = -0.6\text{ A}, T_J = 125^{\circ}\text{C}$	-	400	700	
g_{FS}	Forward Transconductance	Q1	$V_{DS} = 5\text{ V}, I_D = 0.7\text{ A}$	-	2.8	-	S
		Q2	$V_{DS} = -5\text{ V}, I_D = -0.6\text{ A}$	-	1.8	-	
$I_{D(on)}$	On-State Drain Current	Q1	$V_{GS} = 4.5\text{ V}, V_{DS} = 5\text{ V}$	1	-	-	A
		Q2	$V_{GS} = -4.5\text{ V}, V_{DS} = -5\text{ V}$	-2	-	-	

DYNAMIC CHARACTERISTICS

C_{iss}	Input Capacitance	Q1	$V_{DS} = 10\text{ V}, V_{GS} = 0\text{ V}, f = 1.0\text{ MHz}$	-	113	-	pF
		Q2	$V_{DS} = -10\text{ V}, V_{GS} = 0\text{ V}, f = 1.0\text{ MHz}$	-	114	-	
C_{oss}	Output Capacitance	Q1	$V_{DS} = 10\text{ V}, V_{GS} = 0\text{ V}, f = 1.0\text{ MHz}$	-	34	-	pF
		Q2	$V_{DS} = -10\text{ V}, V_{GS} = 0\text{ V}, f = 1.0\text{ MHz}$	-	24	-	

FDG6332C

ELECTRICAL CHARACTERISTICS ($T_A = 25^\circ\text{C}$ unless otherwise noted) (continued)

Symbol	Parameter	Test Conditions	Min	Typ	Max	Unit
--------	-----------	-----------------	-----	-----	-----	------

DYNAMIC CHARACTERISTICS

C_{rss}	Reverse Transfer Capacitance	Q1	V _{DS} = 10 V, V _{GS} = 0 V, f = 1.0 MHz	-	16	-	pF
		Q2	V _{DS} = -10 V, V _{GS} = 0 V, f = 1.0 MHz	-	9	-	

SWITCHING CHARACTERISTICS (Note 2)

$t_{d(on)}$	Turn-On Delay Time	Q1	For Q1 V _{DS} = 10 V, I _D = 1 A, V _{GS} = 4.5 V, R _{GEN} = 6 Ω For Q2 V _{DS} = -10 V, I _D = -1 A, V _{GS} = -4.5 V, R _{GEN} = 6 Ω	-	5	10	ns	
		Q2		-	5.5	11		
t_r	Turn-On Rise Time	Q1		-	7	15	ns	
		Q2		-	14	25		
$t_{d(off)}$	Turn-Off Delay Time	Q1		-	9	18	ns	
		Q2		-	6	12		
t_f	Turn-Off Fall Time	Q1		-	1.5	3	ns	
		Q2		-	1.7	3.4		
Q_g	Total Gate Charge	Q1		For Q1 V _{DS} = 10 V, I _D = 0.7 A, V _{GS} = 4.5 V, R _{GEN} = 6 Ω For Q2 V _{DS} = -10 V, I _D = -0.6 A, V _{GS} = -4.5 V, R _{GEN} = 6 Ω	-	1.1	1.5	nC
		Q2			-	1.4	2	
Q_{gs}	Gate-Source Charge	Q1	-		0.24	-	nC	
		Q2	-		0.3	-		
Q_{gd}	Gate-Drain Charge	Q1	-		0.3	-	nC	
		Q2	-		0.4	-		

DRAIN-SOURCE DIODE CHARACTERISTICS AND MAXIMUM RATINGS

I_S	Maximum Continuous Drain-Source Diode Forward Current	Q1		-	-	0.25	A
		Q2		-	-	-0.25	
V_{SD}	Drain-Source Diode Forward Voltage	Q1	V _{GS} = 0 V, I _S = 0.25 A (Note 2)	-	0.74	1.2	V
		Q2	V _{GS} = 0 V, I _S = -0.25 A (Note 2)	-	-0.77	-1.2	

Product parametric performance is indicated in the Electrical Characteristics for the listed test conditions, unless otherwise noted. Product performance may not be indicated by the Electrical Characteristics if operated under different conditions.

2. Pulse Test: Pulse Width $\leq 300 \mu\text{s}$, Duty Cycle $\leq 2.0\%$

TYPICAL PERFORMANCE CHARACTERISTICS: N-CHANNEL

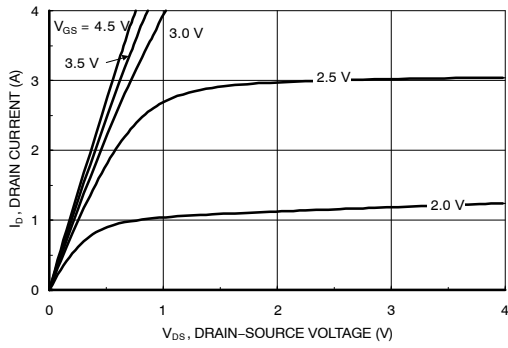

Figure 1. On-Region Characteristics

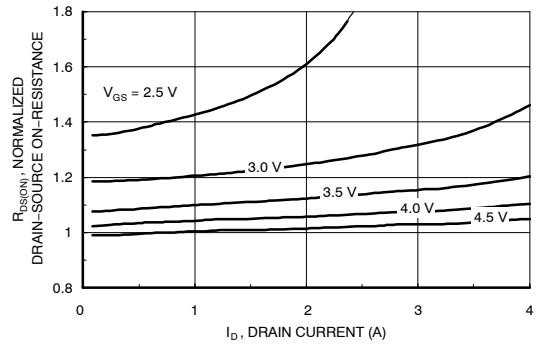

Figure 2. On-Resistance Variation with Drain Current and Gate Voltage

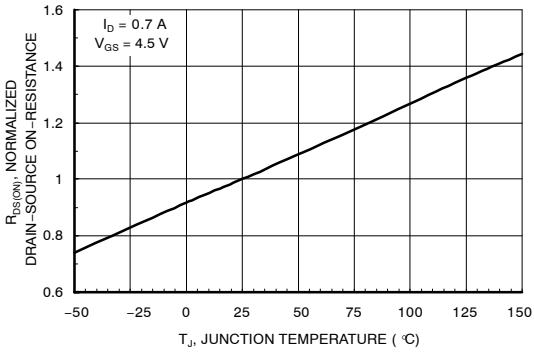

Figure 3. On-Resistance Variation with Temperature

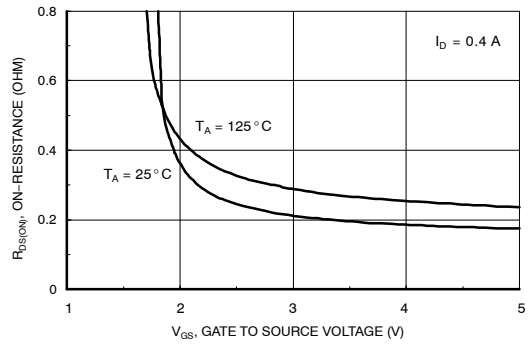

Figure 4. On-Resistance Variation with Gate-to-Source Voltage

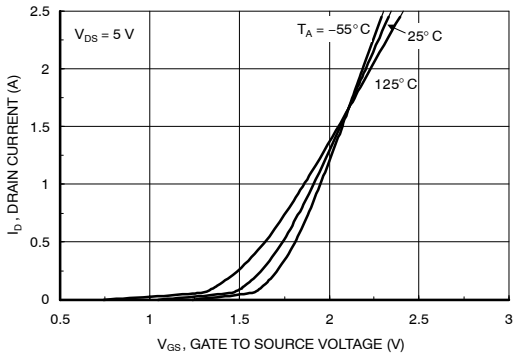

Figure 5. Transfer Characteristics

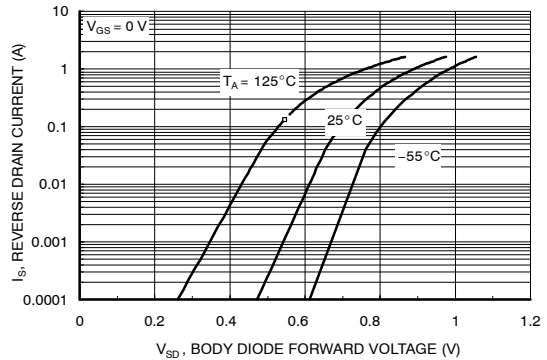

Figure 6. Body Diode Forward Voltage Variation with Source Current and Temperature

TYPICAL PERFORMANCE CHARACTERISTICS: N-CHANNEL (continued)

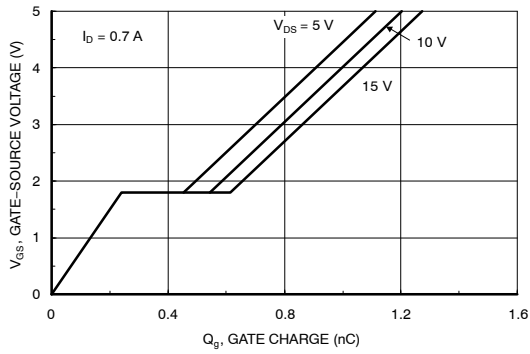

Figure 7. Gate Charge Characteristics

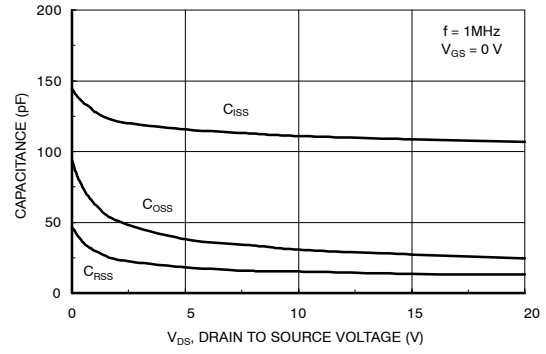

Figure 8. Capacitance Characteristics

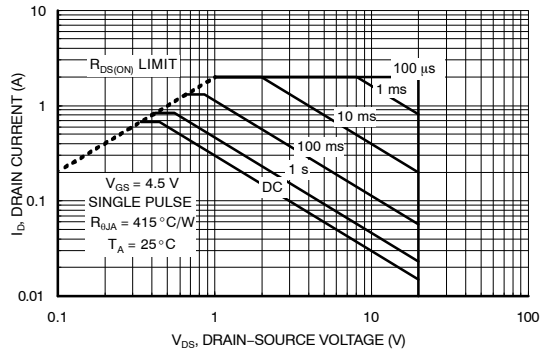

Figure 9. Maximum Safe Operating Area

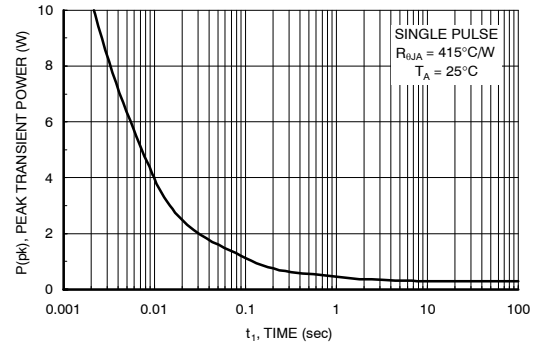

Figure 10. Single Pulse Maximum Power Dissipation

TYPICAL PERFORMANCE CHARACTERISTICS: P-CHANNEL

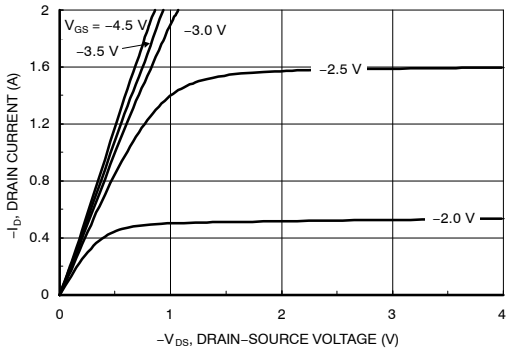

Figure 11. On-Region Characteristics

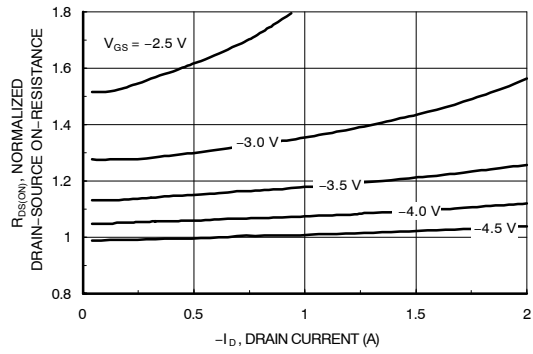

Figure 12. On-Resistance Variation with Drain Current and Gate Voltage

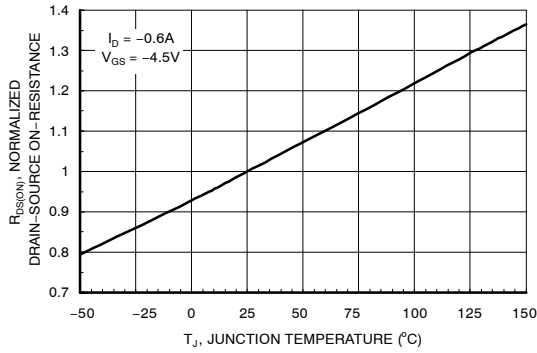

Figure 13. On-Resistance Variation with Temperature

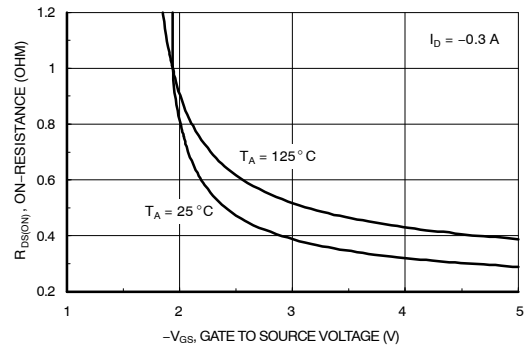

Figure 14. On-Resistance Variation with Gate-to-Source Voltage

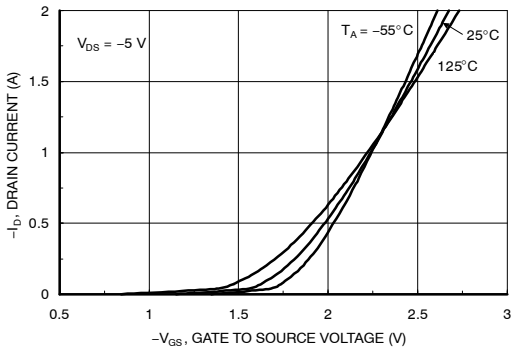

Figure 15. Transfer Characteristics

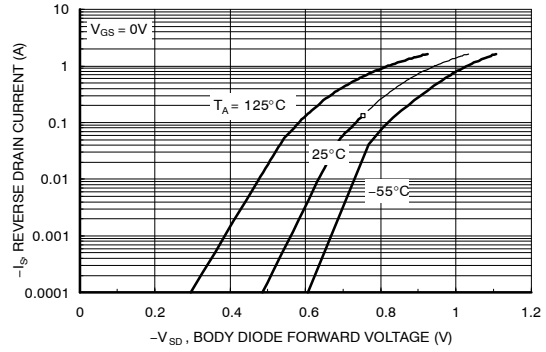

Figure 16. Body Diode Forward Voltage Variation with Source Current and Temperature

TYPICAL PERFORMANCE CHARACTERISTICS: P-CHANNEL (continued)

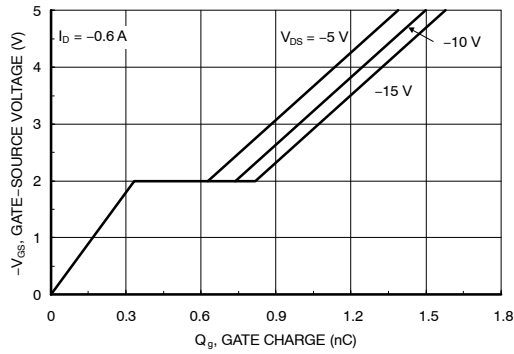

Figure 17. Gate Charge Characteristics

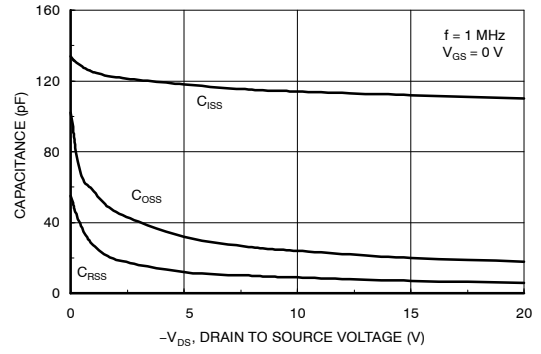

Figure 18. Capacitance Characteristics

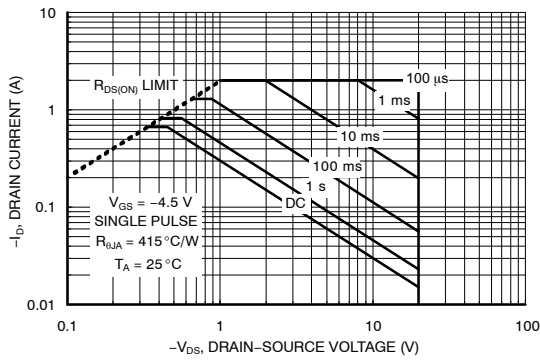

Figure 19. Maximum Safe Operating Area

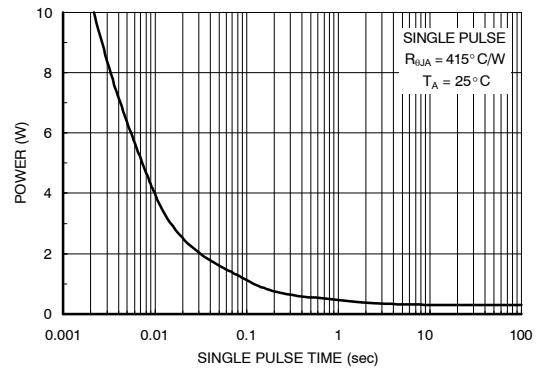
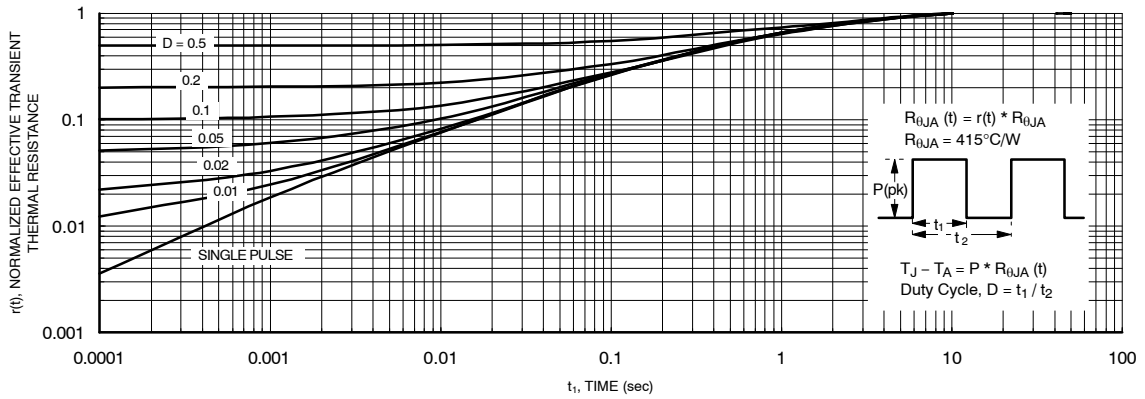

Figure 20. Single Pulse Maximum Power Dissipation



Thermal characterization performed using the conditions described in Note 1.
Transient thermal response will change depending on the circuit board design.

Figure 21. Transient Thermal Response Curve



1
 SCALE 2:1

SC-88/SC70-6/SOT-363
 CASE 419B-02
 ISSUE Y

DATE 11 DEC 2012

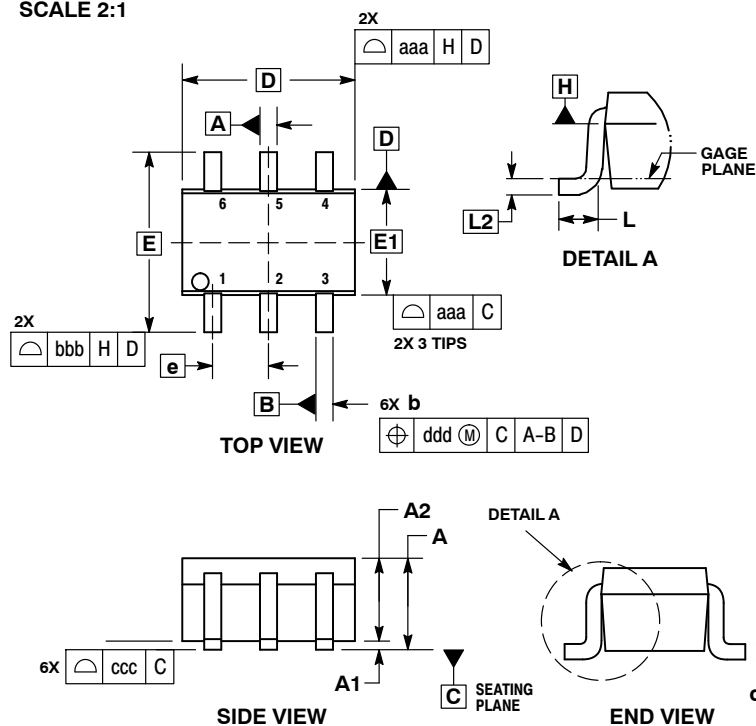

- NOTES:
1. DIMENSIONING AND TOLERANCING PER ASME Y14.5M, 1994.
 2. CONTROLLING DIMENSION: MILLIMETERS.
 3. DIMENSIONS D AND E1 DO NOT INCLUDE MOLD FLASH, PROTRUSIONS, OR GATE BURRS. MOLD FLASH, PROTRUSIONS, OR GATE BURRS SHALL NOT EXCEED 0.20 PER END.
 4. DIMENSIONS D AND E1 AT THE OUTERMOST EXTREMES OF THE PLASTIC BODY AND DATUM H.
 5. DATUMS A AND B ARE DETERMINED AT DATUM H.
 6. DIMENSIONS b AND c APPLY TO THE FLAT SECTION OF THE LEAD BETWEEN 0.08 AND 0.15 FROM THE TIP.
 7. DIMENSION b DOES NOT INCLUDE DAMBAR PROTRUSION. ALLOWABLE DAMBAR PROTRUSION SHALL BE 0.08 TOTAL IN EXCESS OF DIMENSION b AT MAXIMUM MATERIAL CONDITION. THE DAMBAR CANNOT BE LOCATED ON THE LOWER RADIUS OF THE FOOT.

DIM	MILLIMETERS			INCHES		
	MIN	NOM	MAX	MIN	NOM	MAX
A	---	---	1.10	---	---	0.043
A1	0.00	---	0.10	0.000	---	0.004
A2	0.70	0.90	1.00	0.027	0.035	0.039
b	0.15	0.20	0.25	0.006	0.008	0.010
C	0.08	0.15	0.22	0.003	0.006	0.009
D	1.80	2.00	2.20	0.070	0.078	0.086
E	2.00	2.10	2.20	0.078	0.082	0.086
E1	1.15	1.25	1.35	0.045	0.049	0.053
e	0.65 BSC			0.026 BSC		
L	0.26	0.36	0.46	0.010	0.014	0.018
L2	0.15 BSC			0.006 BSC		
aaa	0.15			0.006		
bbb	0.30			0.012		
ccc	0.10			0.004		
ddd	0.10			0.004		

GENERIC MARKING DIAGRAM*

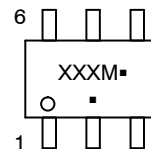

XXX = Specific Device Code
 M = Date Code*
 ▪ = Pb-Free Package

(Note: Microdot may be in either location)

*Date Code orientation and/or position may vary depending upon manufacturing location.

*This information is generic. Please refer to device data sheet for actual part marking. Pb-Free indicator, "G" or microdot "▪", may or may not be present. Some products may not follow the Generic Marking.

RECOMMENDED SOLDERING FOOTPRINT*

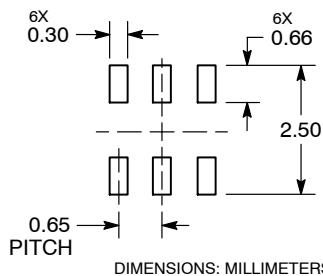

*For additional information on our Pb-Free strategy and soldering details, please download the ON Semiconductor Soldering and Mounting Techniques Reference Manual, SOLDERRM/D.

STYLES ON PAGE 2

DOCUMENT NUMBER:	98ASB42985B	Electronic versions are uncontrolled except when accessed directly from the Document Repository. Printed versions are uncontrolled except when stamped "CONTROLLED COPY" in red.
DESCRIPTION:	SC-88/SC70-6/SOT-363	PAGE 1 OF 2

ON Semiconductor and ON are trademarks of Semiconductor Components Industries, LLC dba ON Semiconductor or its subsidiaries in the United States and/or other countries. ON Semiconductor reserves the right to make changes without further notice to any products herein. ON Semiconductor makes no warranty, representation or guarantee regarding the suitability of its products for any particular purpose, nor does ON Semiconductor assume any liability arising out of the application or use of any product or circuit, and specifically disclaims any and all liability, including without limitation special, consequential or incidental damages. ON Semiconductor does not convey any license under its patent rights nor the rights of others.

SC-88/SC70-6/SOT-363
CASE 419B-02
ISSUE Y

DATE 11 DEC 2012

STYLE 1: PIN 1. EMITTER 2 2. BASE 2 3. COLLECTOR 1 4. EMITTER 1 5. BASE 1 6. COLLECTOR 2	STYLE 2: CANCELLED	STYLE 3: CANCELLED	STYLE 4: PIN 1. CATHODE 2. CATHODE 3. COLLECTOR 4. EMITTER 5. BASE 6. ANODE	STYLE 5: PIN 1. ANODE 2. ANODE 3. COLLECTOR 4. EMITTER 5. BASE 6. CATHODE	STYLE 6: PIN 1. ANODE 2 2. N/C 3. CATHODE 1 4. ANODE 1 5. N/C 6. CATHODE 2
STYLE 7: PIN 1. SOURCE 2 2. DRAIN 2 3. GATE 1 4. SOURCE 1 5. DRAIN 1 6. GATE 2	STYLE 8: CANCELLED	STYLE 9: PIN 1. EMITTER 2 2. EMITTER 1 3. COLLECTOR 1 4. BASE 1 5. BASE 2 6. COLLECTOR 2	STYLE 10: PIN 1. SOURCE 2 2. SOURCE 1 3. GATE 1 4. DRAIN 1 5. DRAIN 2 6. GATE 2	STYLE 11: PIN 1. CATHODE 2 2. CATHODE 2 3. ANODE 1 4. CATHODE 1 5. CATHODE 1 6. ANODE 2	STYLE 12: PIN 1. ANODE 2 2. ANODE 2 3. CATHODE 1 4. ANODE 1 5. ANODE 1 6. CATHODE 2
STYLE 13: PIN 1. ANODE 2. N/C 3. COLLECTOR 4. EMITTER 5. BASE 6. CATHODE	STYLE 14: PIN 1. VREF 2. GND 3. GND 4. IOUT 5. VEN 6. VCC	STYLE 15: PIN 1. ANODE 1 2. ANODE 2 3. ANODE 3 4. CATHODE 3 5. CATHODE 2 6. CATHODE 1	STYLE 16: PIN 1. BASE 1 2. EMITTER 2 3. COLLECTOR 2 4. BASE 2 5. EMITTER 1 6. COLLECTOR 1	STYLE 17: PIN 1. BASE 1 2. EMITTER 1 3. COLLECTOR 2 4. BASE 2 5. EMITTER 2 6. COLLECTOR 1	STYLE 18: PIN 1. VIN1 2. VCC 3. VOUT2 4. VIN2 5. GND 6. VOUT1
STYLE 19: PIN 1. IOUT 2. GND 3. GND 4. V CC 5. V EN 6. V REF	STYLE 20: PIN 1. COLLECTOR 2. COLLECTOR 3. BASE 4. EMITTER 5. COLLECTOR 6. COLLECTOR	STYLE 21: PIN 1. ANODE 1 2. N/C 3. ANODE 2 4. CATHODE 2 5. N/C 6. CATHODE 1	STYLE 22: PIN 1. D1 (i) 2. GND 3. D2 (i) 4. D2 (c) 5. VBUS 6. D1 (c)	STYLE 23: PIN 1. Vn 2. CH1 3. Vp 4. N/C 5. CH2 6. N/C	STYLE 24: PIN 1. CATHODE 2. ANODE 3. CATHODE 4. CATHODE 5. CATHODE 6. CATHODE
STYLE 25: PIN 1. BASE 1 2. CATHODE 3. COLLECTOR 2 4. BASE 2 5. EMITTER 6. COLLECTOR 1	STYLE 26: PIN 1. SOURCE 1 2. GATE 1 3. DRAIN 2 4. SOURCE 2 5. GATE 2 6. DRAIN 1	STYLE 27: PIN 1. BASE 2 2. BASE 1 3. COLLECTOR 1 4. EMITTER 1 5. EMITTER 2 6. COLLECTOR 2	STYLE 28: PIN 1. DRAIN 2. DRAIN 3. GATE 4. SOURCE 5. DRAIN 6. DRAIN	STYLE 29: PIN 1. ANODE 2. ANODE 3. COLLECTOR 4. EMITTER 5. BASE/ANODE 6. CATHODE	STYLE 30: PIN 1. SOURCE 1 2. DRAIN 2 3. DRAIN 2 4. SOURCE 2 5. GATE 1 6. DRAIN 1

Note: Please refer to datasheet for style callout. If style type is not called out in the datasheet refer to the device datasheet pinout or pin assignment.

DOCUMENT NUMBER:	98ASB42985B	Electronic versions are uncontrolled except when accessed directly from the Document Repository. Printed versions are uncontrolled except when stamped "CONTROLLED COPY" in red.
DESCRIPTION:	SC-88/SC70-6/SOT-363	PAGE 2 OF 2

ON Semiconductor and  are trademarks of Semiconductor Components Industries, LLC dba ON Semiconductor or its subsidiaries in the United States and/or other countries. ON Semiconductor reserves the right to make changes without further notice to any products herein. ON Semiconductor makes no warranty, representation or guarantee regarding the suitability of its products for any particular purpose, nor does ON Semiconductor assume any liability arising out of the application or use of any product or circuit, and specifically disclaims any and all liability, including without limitation special, consequential or incidental damages. ON Semiconductor does not convey any license under its patent rights nor the rights of others.

onsemi, **Onsemi**, and other names, marks, and brands are registered and/or common law trademarks of Semiconductor Components Industries, LLC dba "**onsemi**" or its affiliates and/or subsidiaries in the United States and/or other countries. **onsemi** owns the rights to a number of patents, trademarks, copyrights, trade secrets, and other intellectual property. A listing of **onsemi**'s product/patent coverage may be accessed at www.onsemi.com/site/pdf/Patent-Marking.pdf. **onsemi** reserves the right to make changes at any time to any products or information herein, without notice. The information herein is provided "as-is" and **onsemi** makes no warranty, representation or guarantee regarding the accuracy of the information, product features, availability, functionality, or suitability of its products for any particular purpose, nor does **onsemi** assume any liability arising out of the application or use of any product or circuit, and specifically disclaims any and all liability, including without limitation special, consequential or incidental damages. Buyer is responsible for its products and applications using **onsemi** products, including compliance with all laws, regulations and safety requirements or standards, regardless of any support or applications information provided by **onsemi**. "Typical" parameters which may be provided in **onsemi** data sheets and/or specifications can and do vary in different applications and actual performance may vary over time. All operating parameters, including "Typicals" must be validated for each customer application by customer's technical experts. **onsemi** does not convey any license under any of its intellectual property rights nor the rights of others. **onsemi** products are not designed, intended, or authorized for use as a critical component in life support systems or any FDA Class 3 medical devices or medical devices with a same or similar classification in a foreign jurisdiction or any devices intended for implantation in the human body. Should Buyer purchase or use **onsemi** products for any such unintended or unauthorized application, Buyer shall indemnify and hold **onsemi** and its officers, employees, subsidiaries, affiliates, and distributors harmless against all claims, costs, damages, and expenses, and reasonable attorney fees arising out of, directly or indirectly, any claim of personal injury or death associated with such unintended or unauthorized use, even if such claim alleges that **onsemi** was negligent regarding the design or manufacture of the part. **onsemi** is an Equal Opportunity/Affirmative Action Employer. This literature is subject to all applicable copyright laws and is not for resale in any manner.

PUBLICATION ORDERING INFORMATION

LITERATURE FULFILLMENT:

Email Requests to: orderlit@onsemi.com

onsemi Website: www.onsemi.com

TECHNICAL SUPPORT

North American Technical Support:

Voice Mail: 1 800-282-9855 Toll Free USA/Canada

Phone: 011 421 33 790 2910

Europe, Middle East and Africa Technical Support:

Phone: 00421 33 790 2910

For additional information, please contact your local Sales Representative