

RV1S9207A

R08DS0220EJ0100

Rev.1.00

Mar 29,2021

0.6 A OUTPUT CURRENT, HIGH CMR, IGBT GATE DRIVE,
5-PIN SSOP (LSSO5) PHOTOCOUPLER

DESCRIPTION

The RV1S9207A is an optical coupled isolator containing an AlGaAs LED on the input side and a photo diode, a signal processing circuit and power output MOS FETs on the output side on one chip.

The RV1S9207A is designed specifically for high common mode transient immunity (CMR) and high switching speed. It is suitable for driving IGBTs and MOS FETs.

FEATURES

- Small and long creepage (8.2 mm MIN, LSSO5)
- Peak output current (0.6 A MAX., 0.4 A MIN.)
- High speed switching (t_{PLH} , t_{PHL} = 150 ns MAX.)
- High common mode transient immunity (CM_H , CM_L = ± 50 kV/ μ s MIN.)
- Operating Ambient Temperature (125 °C MAX.)
- High isolation voltage (BV = 5 000 Vr.m.s.)
- Embossed tape product : RV1S9207ACCSP-10Yx#KC0 : 3 500 pcs/reel
- Pb-Free product
- Safety standard
 - UL : UL1577, Double protection
 - CSA : CAN/CSA-C22.2 No.62368-1, Reinforced insulation
 - VDE : DIN EN 60747-5-5 (Option)

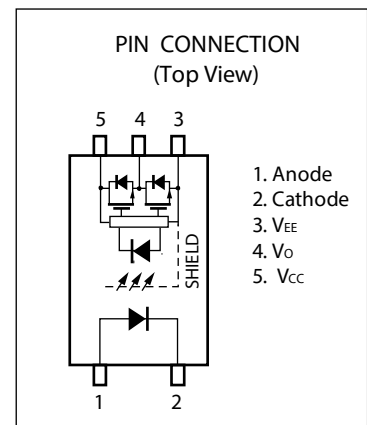

APPLICATIONS

- IGBT, Power MOS FET Gate Driver
- Industrial inverter
- AC Servo

Start of mass production
Feb.2021

PACKAGE DIMENSIONS (UNIT : mm)

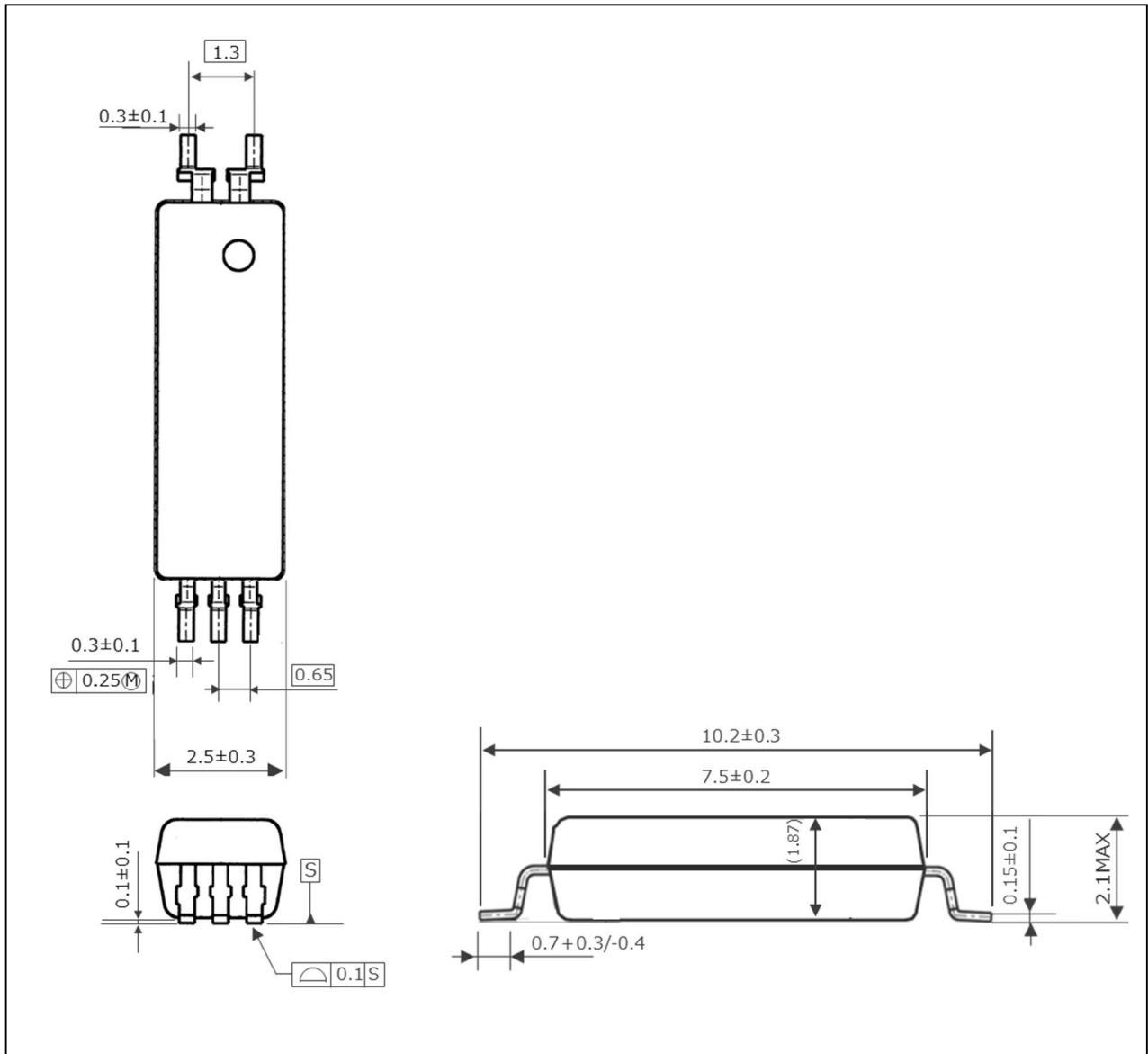

Weight :0.075g (Typ.)

PHOTOCOUPLER CONSTRUCTION

Parameter	MIN.
Air Distance	8.2 mm
Creepage Distance	8.2 mm
Isolation Distance	0.15 mm

MARKING EXAMPLE

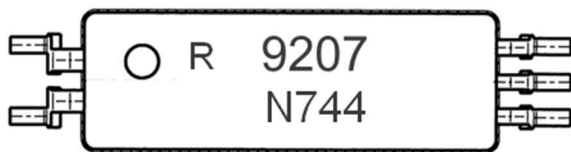

R		An initial of "Renesas"	
9207		Product Part Number *	
○		No.1 pin Mark	
N744	N	Rank Code	
	744	Assembly Lot	
		7	Last one-digit of Assembly Year
		44	Weekly Serial Code

*) Applicable type numbers listed below

RV1S 9207 ACCSP-10Yx

Marking type number. "RV1S" and "ACCSP-10Yx" are omitted from original type number.

ORDERING INFORMATION

Part Number	Order Number	Solder Plating Specification	Packing Style	Safety Standard Approval	Application Part Number*1
RV1S9207ACCSP-10YC	RV1S9207ACCSP-10YC#SC0	Pb-Free and Halogen Free (Ni/Pd/Au)	20 pcs (Tape 20 pcs cut)	Standard products (UL, CSA approved)	RV1S9207A
	RV1S9207ACCSP-10YC#KC0		Embossed Tape 3 500 pcs/reel		
RV1S9207ACCSP-10YV	RV1S9207ACCSP-10YV#SC0		20 pcs (Tape 20 pcs cut)	UL, CSA, DIN EN 60747-5-5 approved	
	RV1S9207ACCSP-10YV#KC0		Embossed Tape 3 500 pcs/reel		

Notes:*1. For the application of the Safety Standard, following part number should be used.

ABSOLUTE MAXIMUM RATINGS ($T_A = 25\text{ }^\circ\text{C}$, unless otherwise specified)

Parameter		Symbol	Ratings	Unit
Diode	Forward Current	I_F	20	mA
	Peak Transient Forward Current (Pulse Width < 1 μs)	$I_{F(\text{TRAN})}$	1.0	A
	Reverse Voltage	V_R	5	V
	Power Dissipation Derating	$\Delta P_D/^\circ\text{C}$	1.2 ($T_A \geq 110\text{ }^\circ\text{C}$)	mW/°C
	Power Dissipation	P_D	45	mW
Detector	High Level Peak Output Current *2	$I_{OH(\text{PEAK})}$	0.6	A
	Low Level Peak Output Current *2	$I_{OL(\text{PEAK})}$	0.6	A
	Supply Voltage	$V_{CC}-V_{EE}$	0 to 35	V
	Output Voltage	V_O	0 to V_{CC}	V
	Power Dissipation Derating	$\Delta P_C/^\circ\text{C}$	3.9 ($T_A \geq 85\text{ }^\circ\text{C}$)	mW/°C
	Power Dissipation	P_C	250	mW
Isolation Voltage *1		BV	5 000	Vr.m.s.
Operating Frequency		f	250	kHz
Operating Ambient Temperature		T_A	-40 to +125	°C
Storage Temperature		T_{stg}	-55 to +150	°C

Notes: *1. AC voltage for 1 minute at $T_A = 25\text{ }^\circ\text{C}$, RH = 60 % between input and output.

Pins 1-2 shorted together, 3-5 shorted together.

*2. Maximum pulse width = 10 μs , Maximum duty cycle = 0.5 %

RECOMMENDED OPERATING CONDITIONS

Parameter	Symbol	MIN.	TYP.	MAX.	Unit
Supply Voltage	$V_{CC} - V_{EE}$	10		30	V
Forward Current (ON)	$I_{F(\text{ON})}$	8	10	12	mA
Forward Voltage (OFF)	$V_{F(\text{OFF})}$	-2		0.8	V
Operating Ambient Temperature	T_A	-40		125	°C

ELECTRICAL CHARACTERISTICS (at RECOMMENDED OPERATING CONDITIONS, $V_{EE} = \text{GND}$, unless otherwise specified)

Parameter		Symbol	Conditions	MIN.	TYP.* 1	MAX.	Unit
Diode	Forward Voltage	V_F	$I_F = 10 \text{ mA}$, $T_A = 25 \text{ }^\circ\text{C}$	1.35	1.56	1.75	V
	Reverse Current	I_R	$V_R = 3 \text{ V}$, $T_A = 25 \text{ }^\circ\text{C}$			10	μA
	Input Capacitance	C_t	$V_F = 0 \text{ V}$, $f = 1 \text{ MHz}$, $T_A = 25 \text{ }^\circ\text{C}$		30		pF
Detector	High Level Output Current	I_{OH}	$V_O = (V_{CC} - 4 \text{ V})^{*2}$	0.2			A
			$V_O = (V_{CC} - 10 \text{ V})^{*3}$	0.4			
	Low Level Output Current	I_{OL}	$V_O = (V_{EE} + 2.5 \text{ V})^{*2}$	0.2			A
			$V_O = (V_{EE} + 10 \text{ V})^{*3}$	0.4			
	High Level Output Voltage	V_{OH}	$I_O = -100 \text{ mA}^{*4}$	$V_{CC} - 3.0 \text{ V}$	$V_{CC} - 1.5 \text{ V}$		V
	Low Level Output Voltage	V_{OL}	$I_O = 100 \text{ mA}$		0.25	1.0	V
	High Level Supply Current	I_{CCH}	$V_O = \text{Open}$, $I_F = 10 \text{ mA}$		1.4	2.0	mA
	Low Level Supply Current	I_{CCL}	$V_O = \text{Open}$, $V_F = 0 \text{ to } 0.8 \text{ V}$		1.3	2.0	mA
	UVLO Threshold	V_{UVLO+}	$V_O > 5 \text{ V}$, $I_F = 10 \text{ mA}$		8.6	9.8	V
V_{UVLO-}		6.8		8.2			
UVLO Hysteresis	$UVLO_{HYS}$			0.4			
Coupled	Threshold Input Current (L \rightarrow H)	I_{FLH}	$I_O = 0 \text{ mA}$, $V_O > 5 \text{ V}$		2.2	5.0	mA
	Threshold Input Voltage (H \rightarrow L)	V_{FHL}	$I_O = 0 \text{ mA}$, $V_O < 5 \text{ V}$	0.8			V

Notes: *1. Typical values at $T_A = 25 \text{ }^\circ\text{C}$, $V_{CC} - V_{EE} = 30 \text{ V}$.

*2. Maximum pulse width = 50 μs , Maximum duty cycle = 0.2 %.

*3. Maximum pulse width = 10 μs , Maximum duty cycle = 0.5 %.

*4. V_{OH} is measured with the pulse load current in this testing (Maximum pulse width = 2 ms, Maximum duty cycle = 20 %).

SWITCHING CHARACTERISTICS (at RECOMMENDED OPERATING CONDITIONS, $V_{EE} = \text{GND}$, unless otherwise specified)

Parameter	Symbol	Conditions	MIN.	TYP.* 1	MAX.	Unit
Propagation Delay Time (L \rightarrow H)	t_{PLH}	$R_g = 47 \text{ } \Omega$, $C_g = 3 \text{ nF}$, $f = 50 \text{ kHz}$, Duty Cycle = 50 %, $I_F = 10 \text{ mA}$, $V_{CC} = 30 \text{ V}$	50	100	150	ns
Propagation Delay Time (H \rightarrow L)	t_{PHL}		50	90	150	ns
Pulse Width Distortion (PWD)	$ t_{PHL} - t_{PLH} $		5	50		ns
Propagation Delay Difference Between Any Two Parts (PDD)	$t_{PHL} - t_{PLH}$		-80		80	ns
Rise Time	t_r		6			ns
Fall Time	t_f		7			ns
Common Mode Transient Immunity at High Level Output	$ CM_H $	$V_{CC} = 30 \text{ V}$, $I_F = 10 \text{ mA}$, $T_A = 25 \text{ }^\circ\text{C}$, $ V_{CM} = 1.5 \text{ kV}$	50			$\text{kV}/\mu\text{s}$
Common Mode Transient Immunity at Low Level Output	$ CM_L $	$V_{CC} = 30 \text{ V}$, $I_F = 0 \text{ mA}$, $T_A = 25 \text{ }^\circ\text{C}$, $ V_{CM} = 1.5 \text{ kV}$	50			$\text{kV}/\mu\text{s}$

Notes: *1. Typical values at $T_A = 25 \text{ }^\circ\text{C}$, $V_{CC} - V_{EE} = 30 \text{ V}$.

TEST CIRCUIT

Fig. 1 I_{OH} Test Circuit

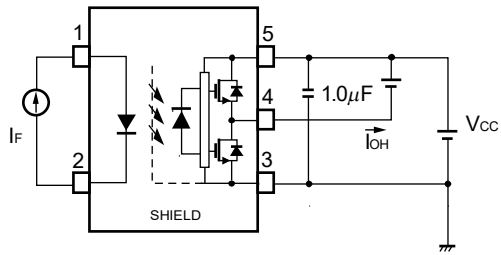

Fig. 2 I_{OL} Test Circuit

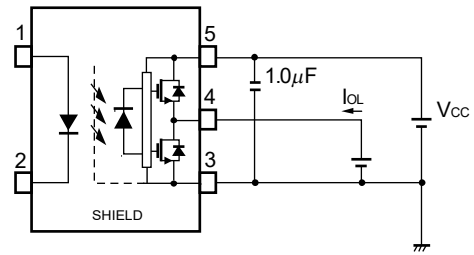

Fig. 3 V_{OH} Test Circuit

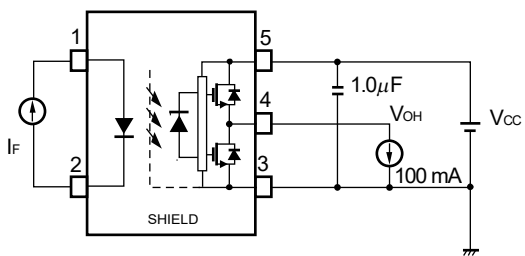

Fig. 4 V_{OL} Test Circuit

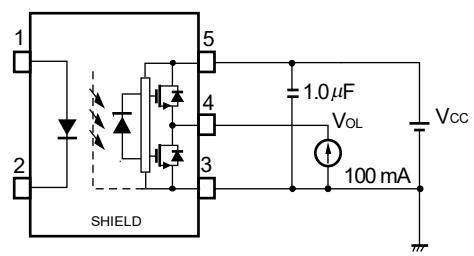

Fig. 5 I_{CCH}/I_{CCL} Test Circuit

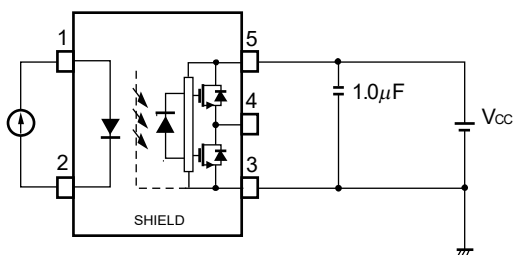

Fig. 6 UVLO Test Circuit

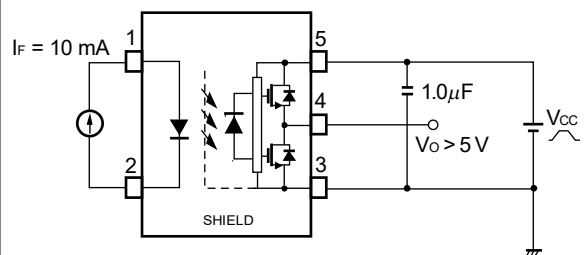

Fig. 7 I_{FLH} Test Circuit

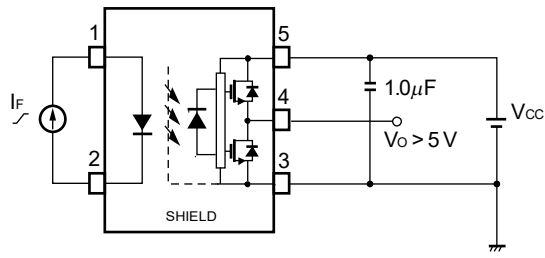

Fig. 8 t_{PLH}, t_{PHL}, t_r, t_f Test Circuit and Wave Forms

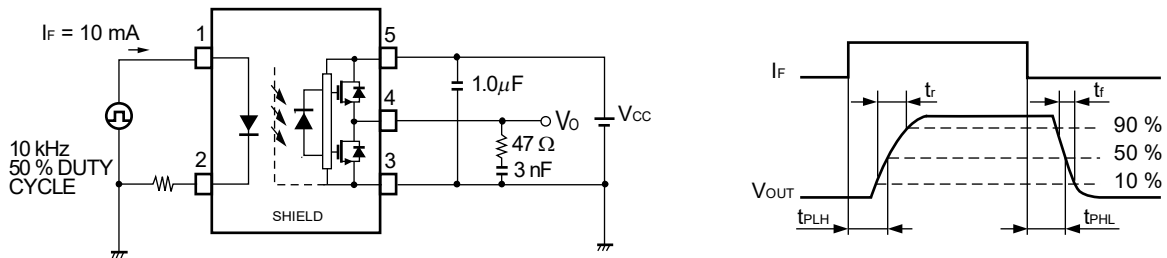
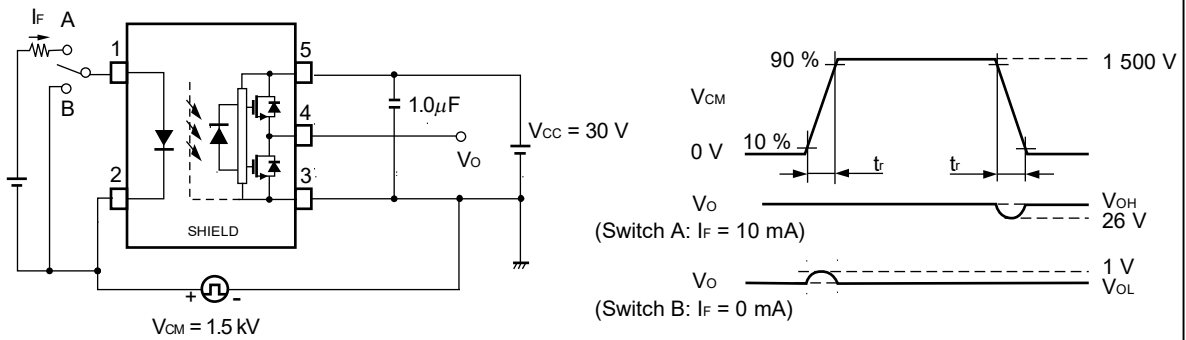
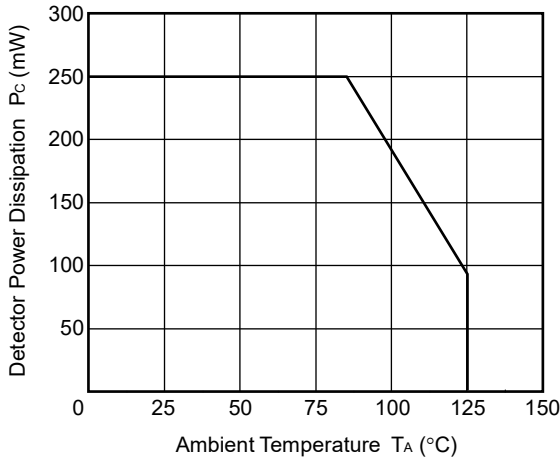

Fig. 9 CMR Test Circuit and Wave Forms



TYPICAL CHARACTERISTICS ($T_A = 25\text{ }^\circ\text{C}$, unless otherwise specified)

DETECTOR POWER DISSIPATION vs. AMBIENT TEMPERATURE



DIODE POWER DISSIPATION vs. AMBIENT TEMPERATURE

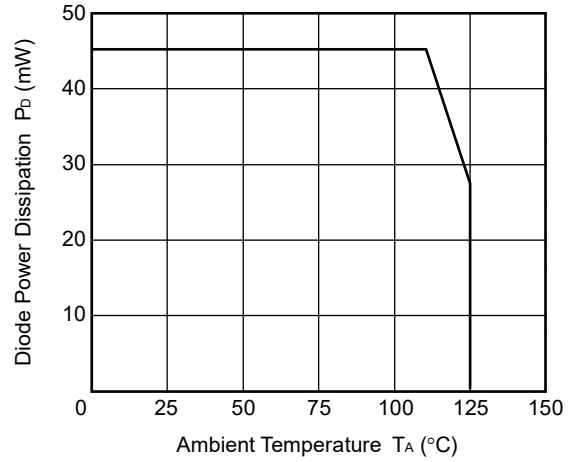

FORWARD CURRENT vs. FORWARD VOLTAGE

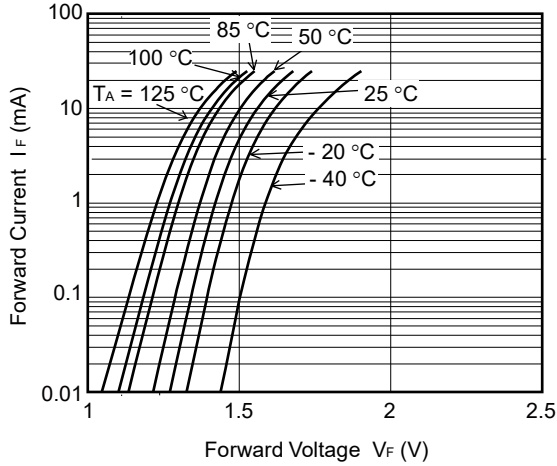

THRESHOLD INPUT CURRENT vs. AMBIENT TEMPERATURE

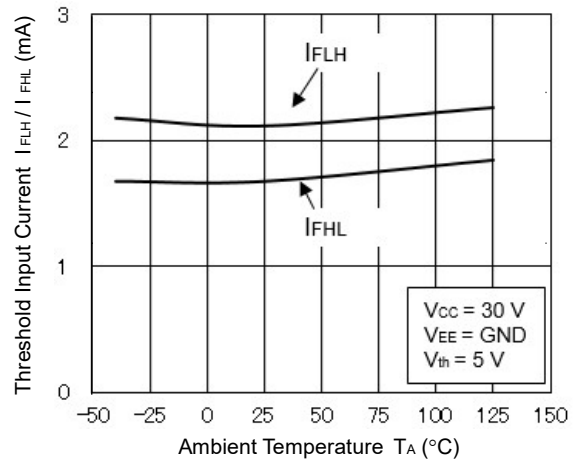

OUTPUT VOLTAGE vs. FORWARD CURRENT

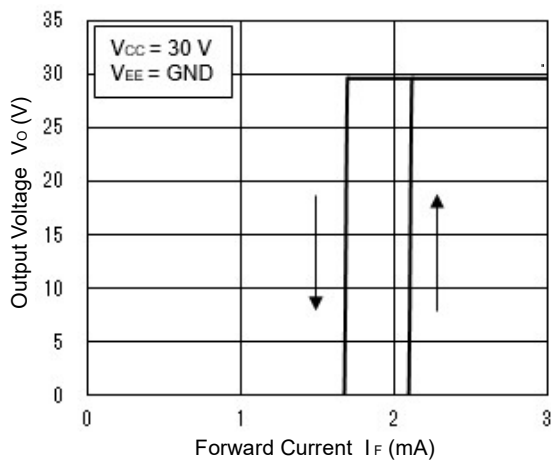

HIGH LEVEL OUTPUT CURRENT vs. HIGH LEVEL OUTPUT VOLTAGE – SUPPLY VOLTAGE

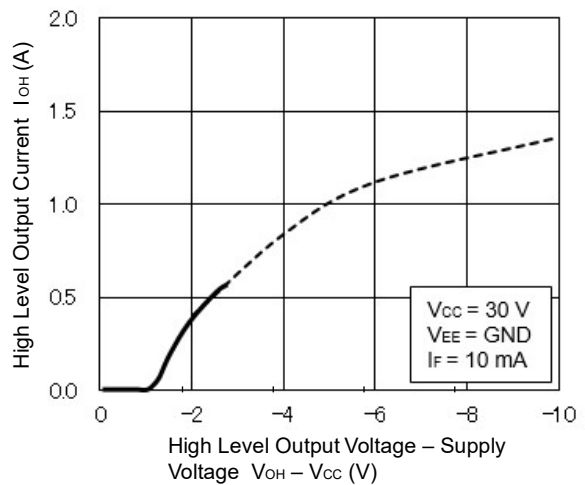

Remark The graphs indicate nominal characteristics.

TYPICAL CHARACTERISTICS (T_A = 25 °C, unless otherwise specified)

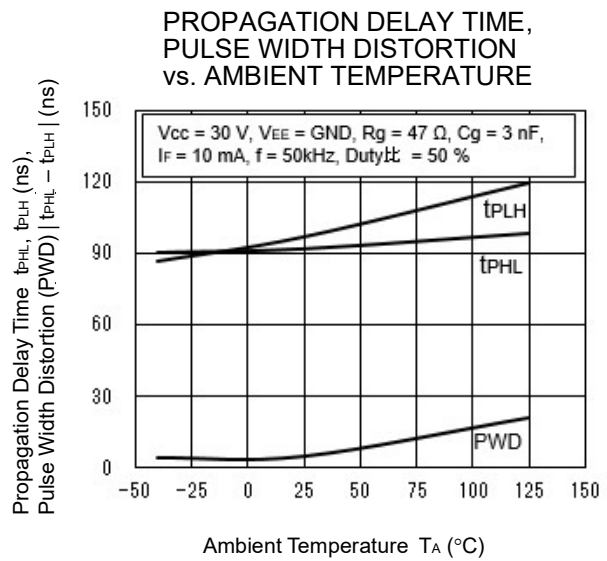
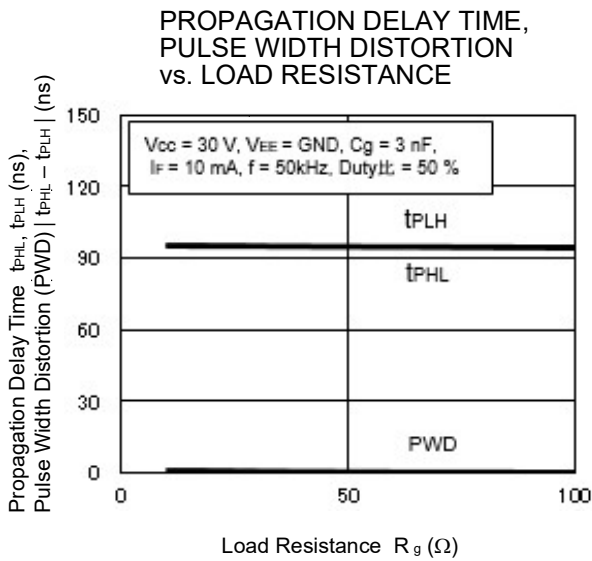
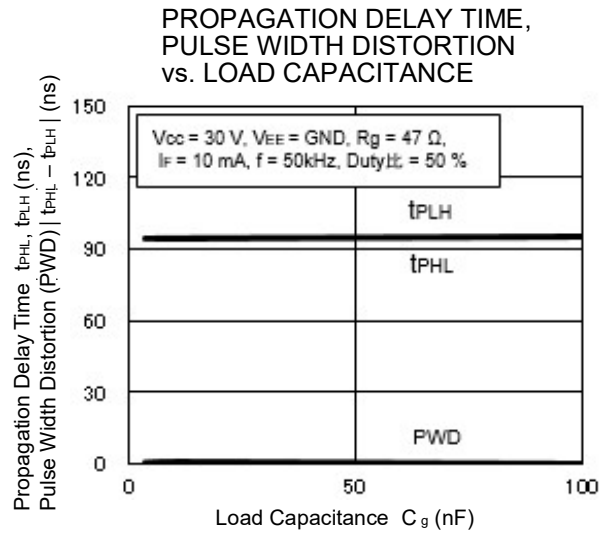
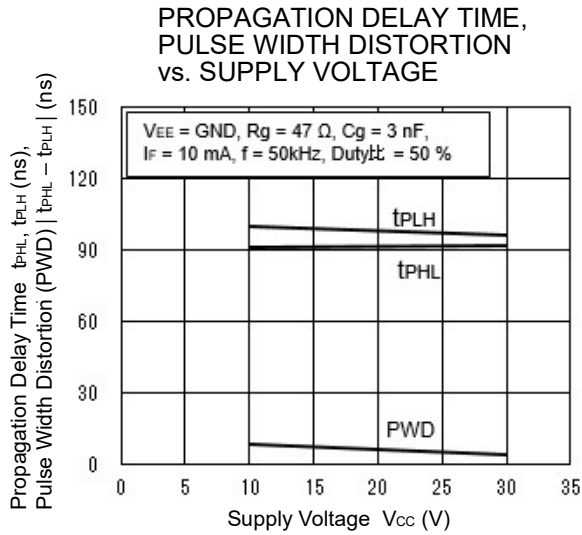
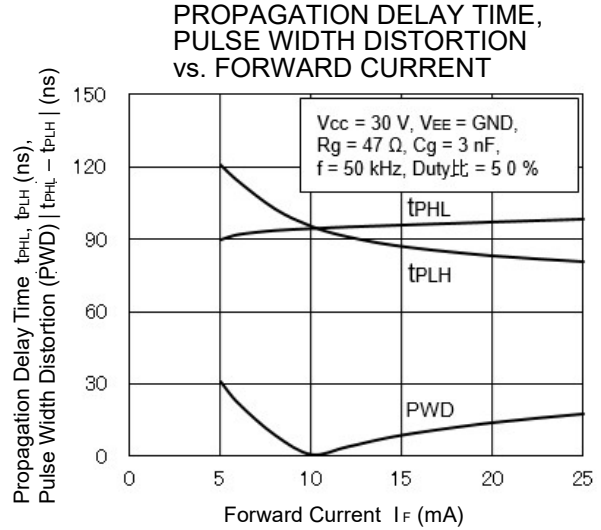
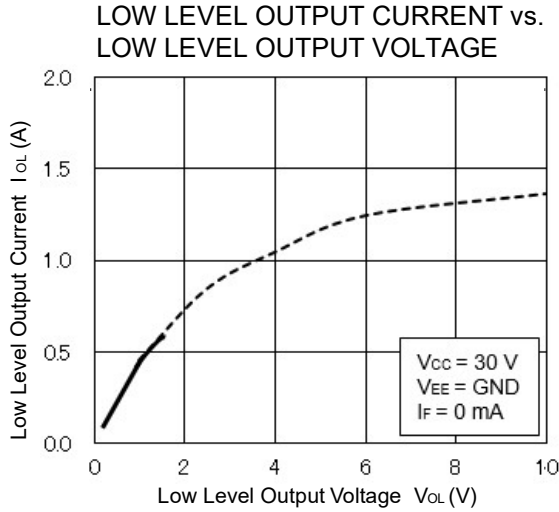

Remark The graphs indicate nominal characteristics.

TYPICAL CHARACTERISTICS (T_A = 25 °C, unless otherwise specified)

SUPPLY CURRENT vs. AMBIENT TEMPERATURE

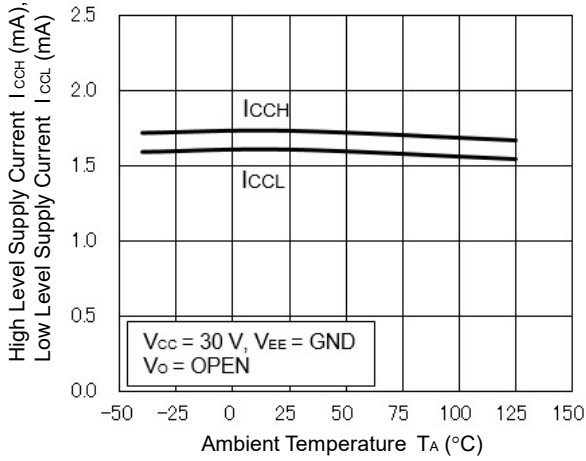

SUPPLY CURRENT vs. SUPPLY VOLTAGE

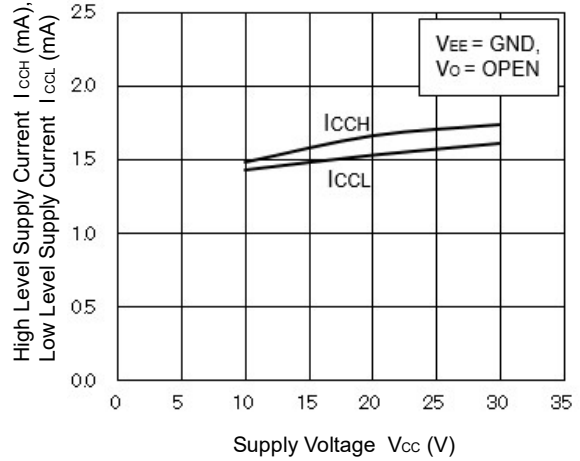

HIGH LEVEL OUTPUT VOLTAGE – SUPPLY VOLTAGE vs. AMBIENT TEMPERATURE

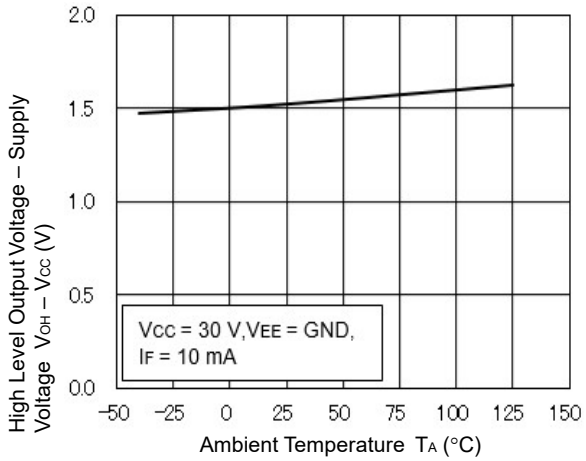

LOW LEVEL OUTPUT VOLTAGE vs. AMBIENT TEMPERATURE

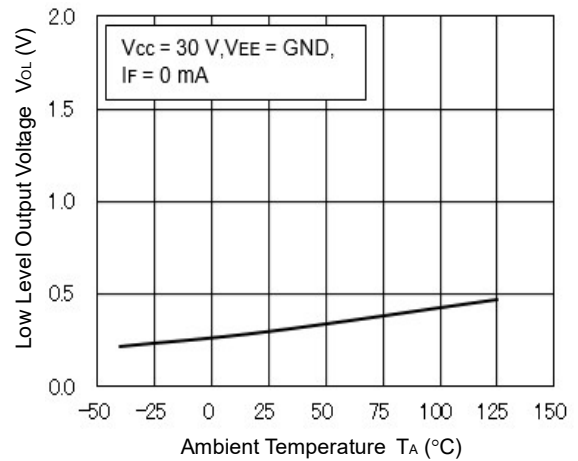

HIGH LEVEL OUTPUT CURRENT vs. AMBIENT TEMPERATURE

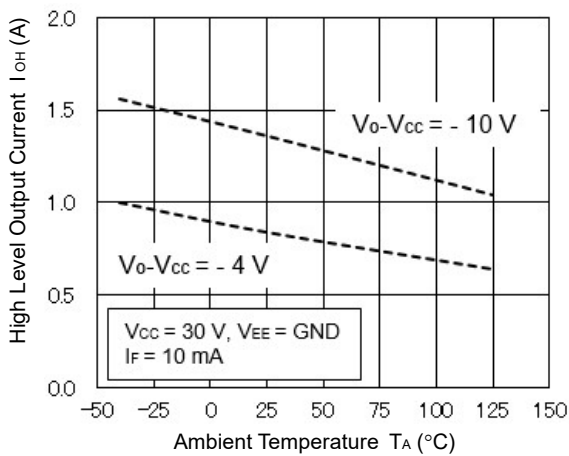

LOW LEVEL OUTPUT CURRENT vs. AMBIENT TEMPERATURE

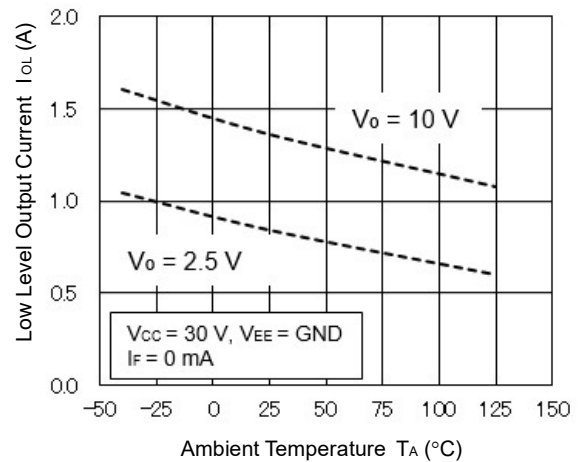

Remark The graphs indicate nominal characteristics.

TYPICAL CHARACTERISTICS (T_A = 25 °C, unless otherwise specified)

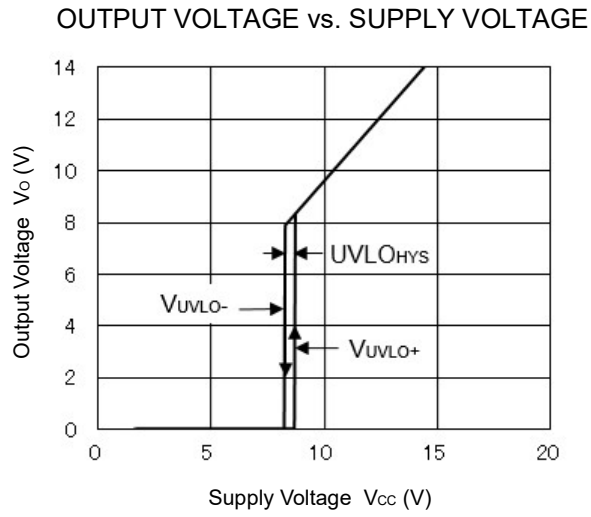

Remark The graphs indicate nominal characteristics.

TAPING SPECIFICATIONS (UNIT : mm)

Tape Direction

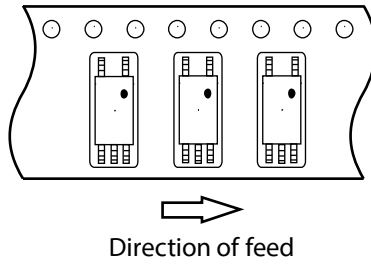

Outline and Dimensions (Tape)

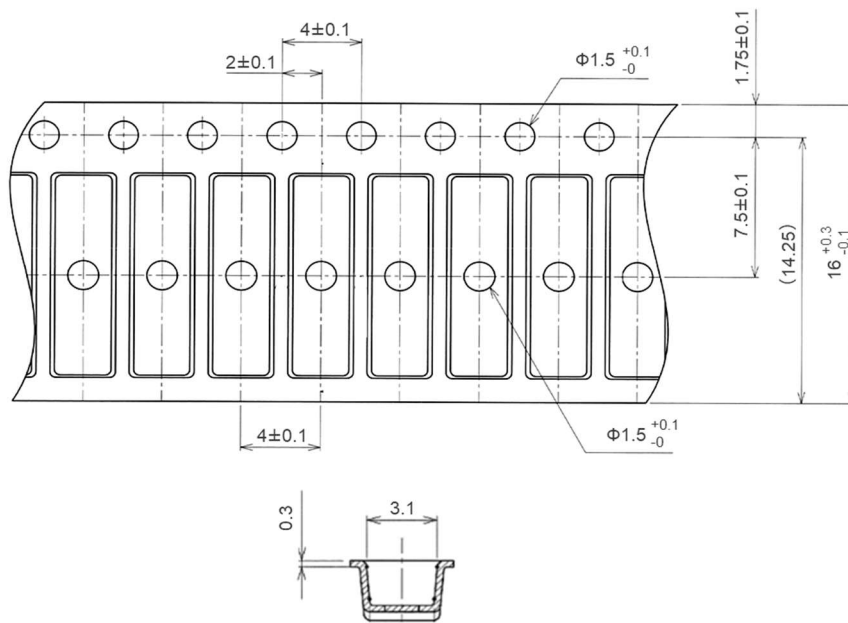

(Unit : mm)

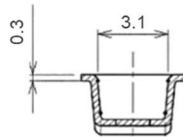
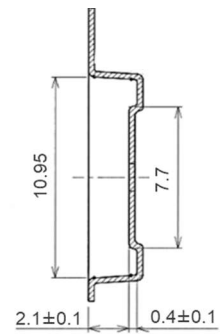

Outline and Dimensions (Reel)

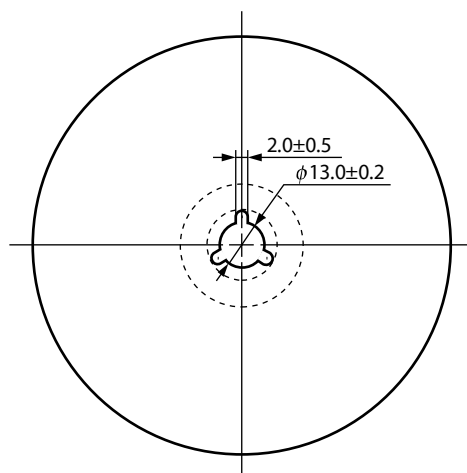

(Unit : mm)

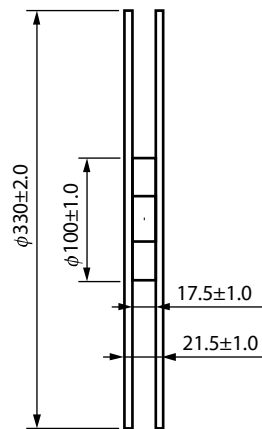

Packing: 3 500 pcs/reel

RECOMMENDED MOUNT PAD DIMENSIONS (UNIT : mm)

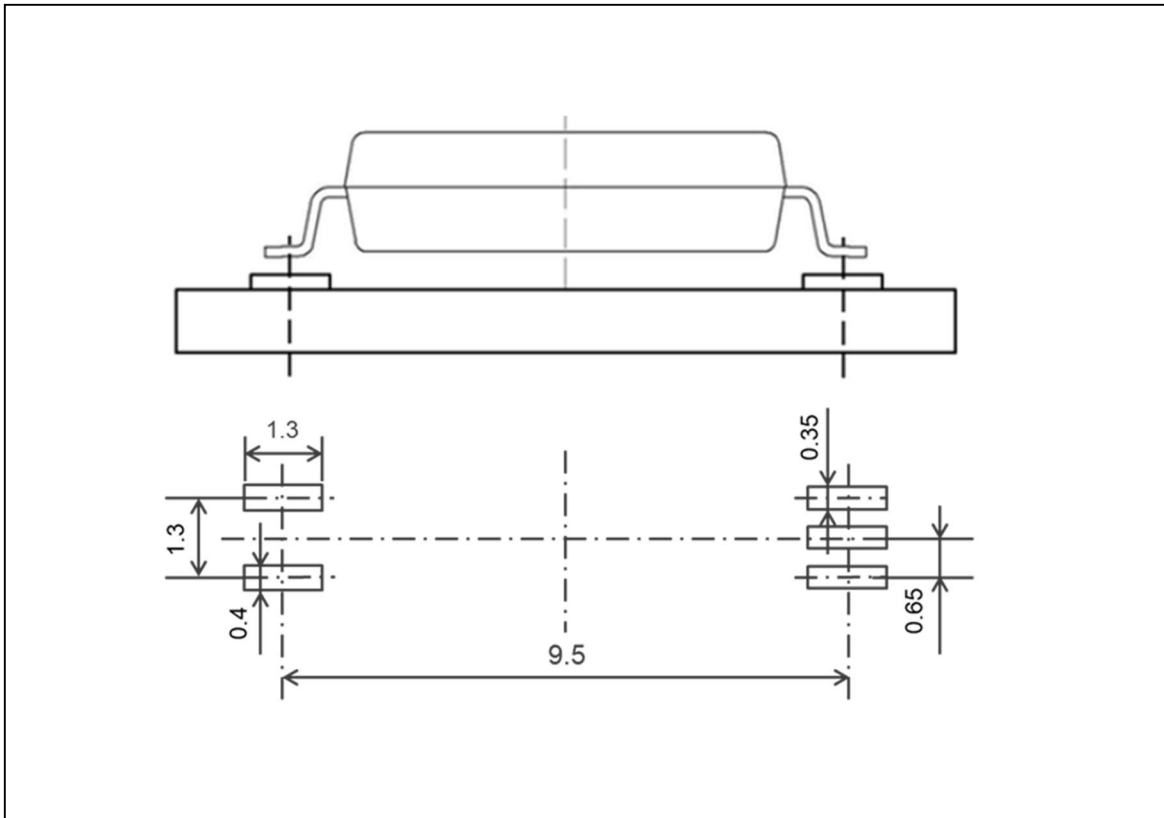

Remark All dimensions in this figure must be evaluated before use.

NOTES ON HANDLING

1. Recommended soldering conditions

(1) Infrared reflow soldering

- Peak reflow temperature 260°C or below (package surface temperature)
- Time of peak reflow temperature 10 seconds or less
- Time of temperature higher than 220°C 60 seconds or less
- Time to preheat temperature from 120 to 180°C 120±30 s
- Number of reflows Three
- Flux Rosin flux containing small amount of chlorine (The flux with a maximum chlorine content of 0.2 Wt% is recommended.)

Recommended Temperature Profile of Infrared Reflow

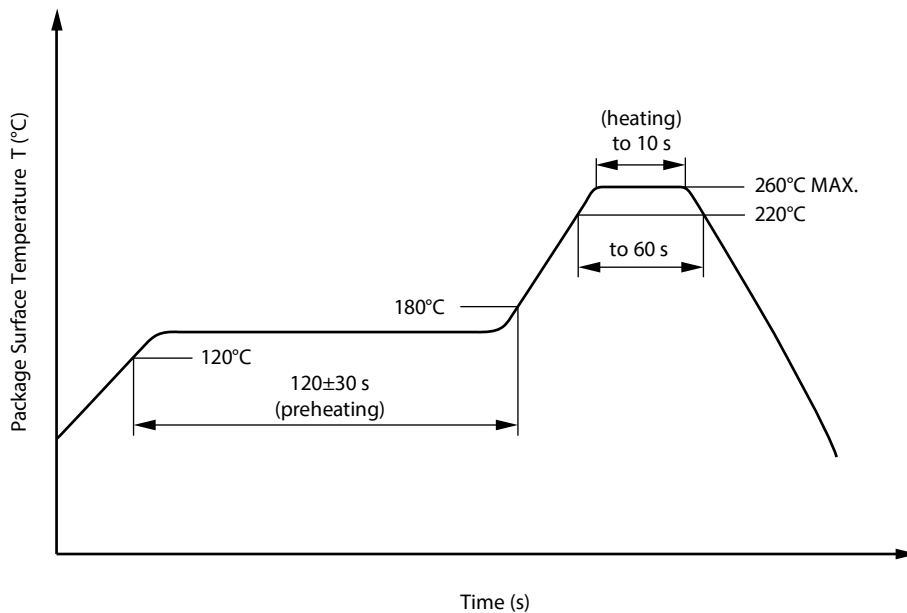

(2) Wave soldering

- Temperature 260°C or below (molten solder temperature)
- Time 10 seconds or less
- Preheating conditions 120°C or below (package surface temperature)
- Number of times One (Allowed to be dipped in solder including plastic mold portion.)
- Flux Rosin flux containing small amount of chlorine (The flux with a maximum chlorine content of 0.2 Wt% is recommended.)

(3) Soldering by Soldering Iron

- Peak Temperature (lead part temperature) 350°C or below
- Time (each pins) 3 seconds or less
- Flux Rosin flux containing small amount of chlorine
(The flux with a maximum chlorine content of 0.2 Wt% is recommended.)

(a) Soldering of leads should be made at the point 1.5 to 2.0 mm from the root of the lead

(b) Please be sure that the temperature of the package would not be heated over 100°C

(4) Cautions

- Flux Cleaning
Avoid cleaning with Freon based or halogen-based (chlorinated etc.) solvents.
- Do not use fixing agents or coatings containing halogen-based substances.

2. Cautions regarding noise

Be aware that when voltage is applied suddenly between the photocoupler's input and output at startup, the output transistor may enter the on state, even if the voltage is within the absolute maximum ratings.

USAGE CAUTIONS

1. This product is weak for static electricity by designed with high-speed integrated circuit so protect against static electricity when handling.
2. Board designing
 - (1) By-pass capacitor of more than 1.0 μ F is used between V_{CC} and GND near device. Also, ensure that the distance between the leads of the photocoupler and capacitor is no more than 10 mm.
 - (2) When designing the printed wiring board, ensure that the pattern of the IGBT collectors/emitters is not too close to the input block pattern of the photocoupler.
If the pattern is too close to the input block and coupling occurs, a sudden fluctuation in the voltage on the IGBT output side might affect the photocoupler's LED input, leading to malfunction or degradation of characteristics.
(If the pattern needs to be close to the input block, to prevent the LED from lighting during the off state due to the abovementioned coupling, design the input-side circuit so that the bias of the LED is reversed, within the range of the recommended operating conditions, and be sure to thoroughly evaluate operation.)
3. Make sure the rise/fall time of the forward current is 0.5 μ s or less.
4. In order to avoid malfunctions, make sure the rise/fall slope of the supply voltage is 3 V/ μ s or less.
5. Avoid storage at a high temperature and high humidity.

SPECIFICATION OF VDE MARKS LICENSE DOCUMENT

Parameter	Symbol	Rating	Unit
Climatic test class (IEC 60068-1/DIN EN 60068-1)		40/125/21	
Dielectric strength maximum operating isolation voltage	U_{IORM}	1 075	V_{peak}
Test voltage (partial discharge test, procedure a for type test and random test) $U_{pr} = 1.6 \times U_{IORM}, P_d < 5 \text{ pC}$	U_{pr}	1 720	V_{peak}
Test voltage (partial discharge test, procedure b for all devices) $U_{pr} = 1.875 \times U_{IORM}, P_d < 5 \text{ pC}$	U_{pr}	2 016	V_{peak}
Highest permissible overvoltage	U_{IOTM}	8 000	V_{peak}
Degree of pollution (IEC 60664-1/DIN EN 60664-1 (VDE 0110-1))		2	
Comparative tracking index (IEC 60112/DIN EN 60112 (VDE 0303-11))	CTI	400	
Material group (IEC 60664-1/DIN EN 60664-1 (VDE 0110-1))		II	
Storage temperature range	T_{stg}	-55~+150	°C
Operating temperature range	T_A	-40~+125	°C
Isolation resistance, minimum value $V_{IO} = 500 \text{ V dc at } T_A = 25^\circ\text{C}$ $V_{IO} = 500 \text{ V dc at } T_A \text{ MAX. at least } 100^\circ\text{C}$	Ris MIN. Ris MIN.	10^{12} 10^{11}	Ω Ω
Safety maximum ratings (maximum permissible in case of fault, see thermal derating curve) Package temperature	T_{si}	175	°C
Current (input current I_F , $\Psi_i = 0$)	I_{si}	400	mA
Power (output or total power dissipation)	Ψ_i	700	mW
Isolation resistance $V_{IO} = 500 \text{ V dc at } T_A = T_{si}$	Ris MIN.	10^9	Ω

Dependence of maximum safety ratings with package temperature

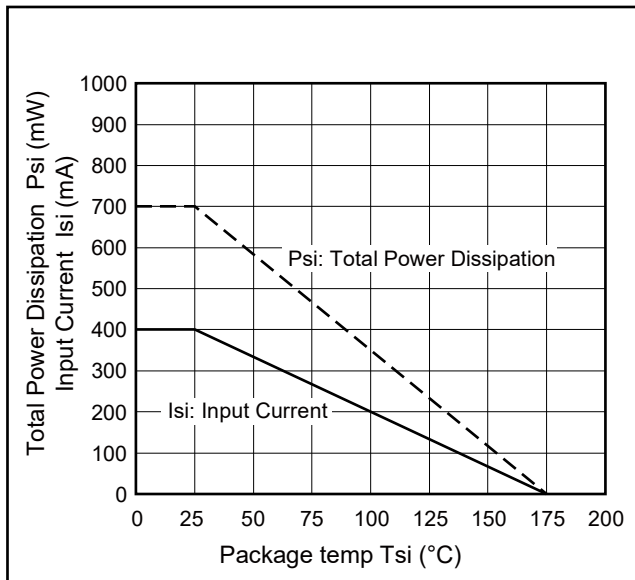

Method a) Destructive Test, Type and Sample Test

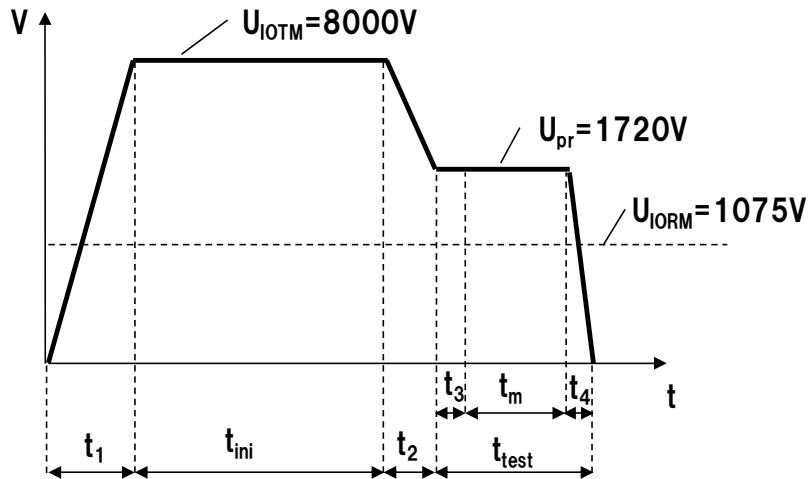

$t_1, t_2 = 1 \text{ to } 10 \text{ sec}$
 $t_3, t_4 = 1 \text{ sec}$
 $t_m \text{ (PARTIAL DISCHARGE)} = 10 \text{ sec}$
 $t_{\text{test}} = 12 \text{ sec}$
 $t_{\text{ini}} = 60 \text{ sec}$

Method b) Non-destructive Test, 100% Production Test

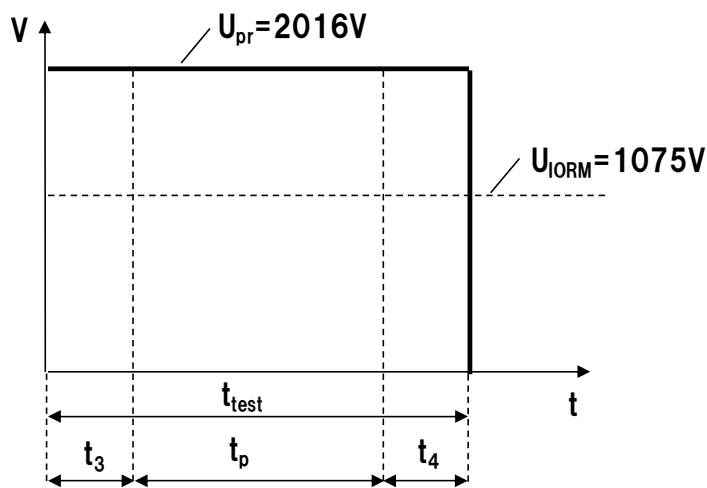

$t_3, t_4 = 0.1 \text{ sec}$
 $t_p \text{ (PARTIAL DISCHARGE)} = 1.0 \text{ sec}$
 $t_{\text{test}} = 1.2 \text{ sec}$

Caution	GaAs Products	<p>This product uses gallium arsenide (GaAs). GaAs vapor and powder are hazardous to human health if inhaled or ingested, so please observe the following points.</p> <ul style="list-style-type: none">• Follow related laws and ordinances when disposing of the product. If there are no applicable laws and/or ordinances, dispose of the product as recommended below.<ol style="list-style-type: none">1. Commission a disposal company able to (with a license to) collect, transport and dispose of materials that contain arsenic and other such industrial waste materials.2. Exclude the product from general industrial waste and household garbage, and ensure that the product is controlled (as industrial waste subject to special control) up until final disposal.• Do not burn, destroy, cut, crush, or chemically dissolve the product.• Do not lick the product or in any way allow it to enter the mouth.
----------------	---------------	----------------------------------------------------------------------------------------------------------------------------------------------------------------------------------------------------------------------------------------------------------------------------------------------------------------------------------------------------------------------------------------------------------------------------------------------------------------------------------------------------------------------------------------------------------------------------------------------------------------------------------------------------------------------------------------------------------------------------------------------------------------------------------------------------------------------------------------------------------------------------------------------------------------------------------------------------------------------------------------

All trademarks and registered trademarks are the property of their respective owners.

Notice

1. Descriptions of circuits, software and other related information in this document are provided only to illustrate the operation of semiconductor products and application examples. You are fully responsible for the incorporation or any other use of the circuits, software, and information in the design of your product or system. Renesas Electronics disclaims any and all liability for any losses and damages incurred by you or third parties arising from the use of these circuits, software, or information.
 2. Renesas Electronics hereby expressly disclaims any warranties against and liability for infringement or any other claims involving patents, copyrights, or other intellectual property rights of third parties, by or arising from the use of Renesas Electronics products or technical information described in this document, including but not limited to, the product data, drawings, charts, programs, algorithms, and application examples.
 3. No license, express, implied or otherwise, is granted hereby under any patents, copyrights or other intellectual property rights of Renesas Electronics or others.
 4. You shall be responsible for determining what licenses are required from any third parties, and obtaining such licenses for the lawful import, export, manufacture, sales, utilization, distribution or other disposal of any products incorporating Renesas Electronics products, if required.
 5. You shall not alter, modify, copy, or reverse engineer any Renesas Electronics product, whether in whole or in part. Renesas Electronics disclaims any and all liability for any losses or damages incurred by you or third parties arising from such alteration, modification, copying or reverse engineering.
 6. Renesas Electronics products are classified according to the following two quality grades: "Standard" and "High Quality". The intended applications for each Renesas Electronics product depends on the product's quality grade, as indicated below.
 - "Standard": Computers; office equipment; communications equipment; test and measurement equipment; audio and visual equipment; home electronic appliances; machine tools; personal electronic equipment; industrial robots; etc.
 - "High Quality": Transportation equipment (automobiles, trains, ships, etc.); traffic control (traffic lights); large-scale communication equipment; key financial terminal systems; safety control equipment; etc.
- Unless expressly designated as a high reliability product or a product for harsh environments in a Renesas Electronics data sheet or other Renesas Electronics document, Renesas Electronics products are not intended or authorized for use in products or systems that may pose a direct threat to human life or bodily injury (artificial life support devices or systems; surgical implantations; etc.), or may cause serious property damage (space system; undersea repeaters; nuclear power control systems; aircraft control systems; key plant systems; military equipment; etc.). Renesas Electronics disclaims any and all liability for any damages or losses incurred by you or any third parties arising from the use of any Renesas Electronics product that is inconsistent with any Renesas Electronics data sheet, user's manual or other Renesas Electronics document.
7. No semiconductor product is absolutely secure. Notwithstanding any security measures or features that may be implemented in Renesas Electronics hardware or software products, Renesas Electronics shall have absolutely no liability arising out of any vulnerability or security breach, including but not limited to any unauthorized access to or use of a Renesas Electronics product or a system that uses a Renesas Electronics product. RENESAS ELECTRONICS DOES NOT WARRANT OR GUARANTEE THAT RENESAS ELECTRONICS PRODUCTS, OR ANY SYSTEMS CREATED USING RENESAS ELECTRONICS PRODUCTS WILL BE INVULNERABLE OR FREE FROM CORRUPTION, ATTACK, VIRUSES, INTERFERENCE, HACKING, DATA LOSS OR THEFT, OR OTHER SECURITY INTRUSION ("Vulnerability Issues"). RENESAS ELECTRONICS DISCLAIMS ANY AND ALL RESPONSIBILITY OR LIABILITY ARISING FROM OR RELATED TO ANY VULNERABILITY ISSUES. FURTHERMORE, TO THE EXTENT PERMITTED BY APPLICABLE LAW, RENESAS ELECTRONICS DISCLAIMS ANY AND ALL WARRANTIES, EXPRESS OR IMPLIED, WITH RESPECT TO THIS DOCUMENT AND ANY RELATED OR ACCOMPANYING SOFTWARE OR HARDWARE, INCLUDING BUT NOT LIMITED TO THE IMPLIED WARRANTIES OF MERCHANTABILITY, OR FITNESS FOR A PARTICULAR PURPOSE.
 8. When using Renesas Electronics products, refer to the latest product information (data sheets, user's manuals, application notes, "General Notes for Handling and Using Semiconductor Devices" in the reliability handbook, etc.), and ensure that usage conditions are within the ranges specified by Renesas Electronics with respect to maximum ratings, operating power supply voltage range, heat dissipation characteristics, installation, etc. Renesas Electronics disclaims any and all liability for any malfunctions, failure or accident arising out of the use of Renesas Electronics products outside of such specified ranges.
 9. Although Renesas Electronics endeavors to improve the quality and reliability of Renesas Electronics products, semiconductor products have specific characteristics, such as the occurrence of failure at a certain rate and malfunctions under certain use conditions. Unless designated as a high reliability product or a product for harsh environments in a Renesas Electronics data sheet or other Renesas Electronics document, Renesas Electronics products are not subject to radiation resistance design. You are responsible for implementing safety measures to guard against the possibility of bodily injury, injury or damage caused by fire, and/or danger to the public in the event of a failure or malfunction of Renesas Electronics products, such as safety design for hardware and software, including but not limited to redundancy, fire control and malfunction prevention, appropriate treatment for aging degradation or any other appropriate measures. Because the evaluation of microcomputer software alone is very difficult and impractical, you are responsible for evaluating the safety of the final products or systems manufactured by you.
 10. Please contact a Renesas Electronics sales office for details as to environmental matters such as the environmental compatibility of each Renesas Electronics product. You are responsible for carefully and sufficiently investigating applicable laws and regulations that regulate the inclusion or use of controlled substances, including without limitation, the EU RoHS Directive, and using Renesas Electronics products in compliance with all these applicable laws and regulations. Renesas Electronics disclaims any and all liability for damages or losses occurring as a result of your noncompliance with applicable laws and regulations.
 11. Renesas Electronics products and technologies shall not be used for or incorporated into any products or systems whose manufacture, use, or sale is prohibited under any applicable domestic or foreign laws or regulations. You shall comply with any applicable export control laws and regulations promulgated and administered by the governments of any countries asserting jurisdiction over the parties or transactions.
 12. It is the responsibility of the buyer or distributor of Renesas Electronics products, or any other party who distributes, disposes of, or otherwise sells or transfers the product to a third party, to notify such third party in advance of the contents and conditions set forth in this document.
 13. This document shall not be reprinted, reproduced or duplicated in any form, in whole or in part, without prior written consent of Renesas Electronics.
 14. Please contact a Renesas Electronics sales office if you have any questions regarding the information contained in this document or Renesas Electronics products.

(Note1) "Renesas Electronics" as used in this document means Renesas Electronics Corporation and also includes its directly or indirectly controlled subsidiaries.

(Note2) "Renesas Electronics product(s)" means any product developed or manufactured by or for Renesas Electronics.

(Rev.5.0-1 October 2020)

Corporate Headquarters

TOYOSU FORESIA, 3-2-24 Toyosu,
Koto-ku, Tokyo 135-0061, Japan
www.renesas.com

Trademarks

Renesas and the Renesas logo are trademarks of Renesas Electronics Corporation. All trademarks and registered trademarks are the property of their respective owners.

Contact information

For further information on a product, technology, the most up-to-date version of a document, or your nearest sales office, please visit:
www.renesas.com/contact/.