

# MMBV2101LT1 Series, MV2105, MV2101, MV2109, LV2209

Preferred Device

## Silicon Tuning Diodes

These devices are designed in popular plastic packages for the high volume requirements of FM Radio and TV tuning and AFC, general frequency control and tuning applications. They provide solid-state reliability in replacement of mechanical tuning methods. Also available in a Surface Mount Package up to 33 pF.

### Features

- High Q
- Controlled and Uniform Tuning Ratio
- Standard Capacitance Tolerance – 10%
- Complete Typical Design Curves
- Pb-Free Packages are Available

### MAXIMUM RATINGS

Rating	Symbol	Value	Unit
Reverse Voltage	$V_R$	30	Vdc
Forward Current	$I_F$	200	mAdc
Forward Power Dissipation @ $T_A = 25^\circ\text{C}$ Derate above $25^\circ\text{C}$	$P_D$	225 1.8	mW mW/ $^\circ\text{C}$
MMBV21xx			
@ $T_A = 25^\circ\text{C}$ Derate above $25^\circ\text{C}$		280 2.8	mW mW/ $^\circ\text{C}$
MV21xx LV2209			
Junction Temperature	$T_J$	+150	$^\circ\text{C}$
Storage Temperature Range	$T_{stg}$	-55 to +150	$^\circ\text{C}$

Maximum ratings are those values beyond which device damage can occur. Maximum ratings applied to the device are individual stress limit values (not normal operating conditions) and are not valid simultaneously. If these limits are exceeded, device functional operation is not implied, damage may occur and reliability may be affected.

### ELECTRICAL CHARACTERISTICS ( $T_A = 25^\circ\text{C}$ unless otherwise noted)

Characteristic	Symbol	Min	Typ	Max	Unit
Reverse Breakdown Voltage ( $I_R = 10 \mu\text{Adc}$ )	$V_{(BR)R}$	30 25	- -	- -	Vdc
MMBV21xx, MV21xx LV2209					
Reverse Voltage Leakage Current ( $V_R = 25 \text{ Vdc}$ , $T_A = 25^\circ\text{C}$ )	$I_R$	-	-	0.1	$\mu\text{Adc}$
Diode Capacitance Temperature Coefficient ( $V_R = 4.0 \text{ Vdc}$ , $f = 1.0 \text{ MHz}$ )	$TC_C$	-	280	-	ppm/ $^\circ\text{C}$



ON Semiconductor®

<http://onsemi.com>

## 6.8–100 pF, 30 VOLTS VOLTAGE VARIABLE CAPACITANCE DIODES

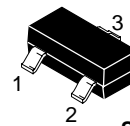
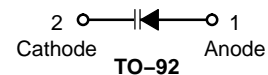
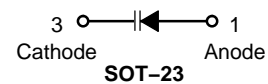

SOT-23 (TO-236)  
CASE 318-08  
STYLE 8

### MARKING DIAGRAMS

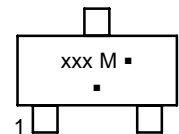

xxx = Specific Device Code

M = Date Code\*

▪ = Pb-Free Package

(Note: Microdot may be in either location)

\*Date Code orientation and/or overbar may vary depending upon manufacturing location.



TO-92 (TO-226AC)  
CASE 182  
STYLE 1

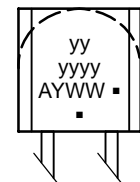

yyyyyy = Specific Device Code

A = Assembly Location

Y = Year

WW = Work Week

▪ = Pb-Free Package

(Note: Microdot may be in either location)

### ORDERING INFORMATION

See detailed ordering and shipping information in the package dimensions section on page 2 of this data sheet.

Preferred devices are recommended choices for future use and best overall value.

## MMBV2101LT1 Series, MV2105, MV2101, MV2109, LV2209

Device	Marking	Package	Shipping†	C <sub>T</sub> , Diode Capacitance V <sub>R</sub> = 4.0 Vdc, f = 1.0 MHz pF			Q, Figure of Merit V <sub>R</sub> = 4.0 Vdc, f = 50 MHz	TR, Tuning Ratio C <sub>2</sub> /C <sub>30</sub> f = 1.0 MHz		
				Min	Nom	Max	Typ	Min	Typ	Max
MMBV2101LT1	M4G	SOT-23	3,000 / Tape & Reel	6.1	6.8	7.5	450	2.5	2.7	3.2
MMBV2101LT1G	M4G	SOT-23 (Pb-Free)	3,000 / Tape & Reel	6.1	6.8	7.5	450	2.5	2.7	3.2
MMBV2101L	M4G	SOT-23	Bulk (Note 1)	6.1	6.8	7.5	450	2.5	2.7	3.2
MV2101	MV2101	TO-92	1,000 per Box	6.1	6.8	7.5	450	2.5	2.7	3.2
MV2101G	MV2101	TO-92 (Pb-Free)	1,000 per Box	6.1	6.8	7.5	450	2.5	2.7	3.2
MMBV2103LT1	4H	SOT-23	3,000 / Tape & Reel	9.0	10	11	400	2.5	2.9	3.2
MMBV2105LT1	4U	SOT-23	3,000 / Tape & Reel	13.5	15	16.5	400	2.5	2.9	3.2
MMBV2105LT1G	4U	SOT-23 (Pb-Free)	3,000 / Tape & Reel	13.5	15	16.5	400	2.5	2.9	3.2
MMBV2105L	4U	SOT-23	Bulk (Note 1)	13.5	15	16.5	400	2.5	2.9	3.2
MV2105	MV2105	TO-92	1,000 per Box	13.5	15	16.5	400	2.5	2.9	3.2
MV2105G	MV2105	TO-92 (Pb-Free)	1,000 per Box	13.5	15	16.5	400	2.5	2.9	3.2
MMBV2107LT1	4W	SOT-23	3,000 / Tape & Reel	19.8	22	24.2	350	2.5	2.9	3.2
MMBV2107LT1G	4W	SOT-23 (Pb-Free)	3,000 / Tape & Reel	19.8	22	24.2	350	2.5	2.9	3.2
MMBV2107L	4W	SOT-23	Bulk (Note 1)	19.8	22	24.2	350	2.5	2.9	3.2
MMBV2108LT1	4X	SOT-23	3,000 / Tape & Reel	24.3	27	29.7	300	2.5	3.0	3.2
MMBV2108LT1G	4X	SOT-23 (Pb-Free)	3,000 / Tape & Reel	24.3	27	29.7	300	2.5	3.0	3.2
LV2209	LV2209	TO-92	1,000 per Box	29.7	33	36.3	200	2.5	3.0	3.2
MMBV2109LT1	4J	SOT-23	3,000 / Tape & Reel	29.7	33	36.3	200	2.5	3.0	3.2
MMBV2109LT1G	4J	SOT-23 (Pb-Free)	3,000 / Tape & Reel	29.7	33	36.3	200	2.5	3.0	3.2
MMBV2109L	4J	SOT-23	Bulk (Note 1)	29.7	33	36.3	200	2.5	3.0	3.2
MV2109	MV2109	TO-92	1,000 per Box	29.7	33	36.3	200	2.5	3.0	3.2
MV2109G	MV2109	TO-92 (Pb-Free)	1,000 per Box	29.7	33	36.3	200	2.5	3.0	3.2

†For information on tape and reel specifications, including part orientation and tape sizes, please refer to our Tape and Reel Packaging Specification Brochure, BRD8011/D.

1. **MMBV2101LT1, MMBV2105LT1, MMBV2107LT1 thru MMBV2109LT1**, are also available in bulk. Use the device title and drop the "T1" suffix when ordering any of these devices in bulk.

### PARAMETER TEST METHODS

#### 1. C<sub>T</sub>, DIODE CAPACITANCE

(C<sub>T</sub> = C<sub>C</sub> + C<sub>J</sub>). C<sub>T</sub> is measured at 1.0 MHz using a capacitance bridge (Boonton Electronics Model 75A or equivalent).

#### 2. TR, TUNING RATIO

TR is the ratio of C<sub>T</sub> measured at 2.0 Vdc divided by C<sub>T</sub> measured at 30 Vdc.

#### 3. Q, FIGURE OF MERIT

Q is calculated by taking the G and C readings of an admittance bridge at the specified frequency and substituting in the following equations:

$$Q = \frac{2\pi f C}{G}$$

(Boonton Electronics Model 33AS8 or equivalent). Use Lead Length  $\approx 1/16''$ .

#### 4. TC<sub>C</sub>, DIODE CAPACITANCE TEMPERATURE COEFFICIENT

TC<sub>C</sub> is guaranteed by comparing C<sub>T</sub> at V<sub>R</sub> = 4.0 Vdc, f = 1.0 MHz, T<sub>A</sub> = -65°C with C<sub>T</sub> at V<sub>R</sub> = 4.0 Vdc, f = 1.0 MHz, T<sub>A</sub> = +85°C in the following equation, which defines TC<sub>C</sub>:

$$TC_C = \left| \frac{C_T(+85^\circ\text{C}) - C_T(-65^\circ\text{C})}{85 + 65} \right| \cdot \frac{10^6}{C_T(25^\circ\text{C})}$$

Accuracy limited by measurement of C<sub>T</sub> to  $\pm 0.1$  pF.

TYPICAL DEVICE CHARACTERISTICS

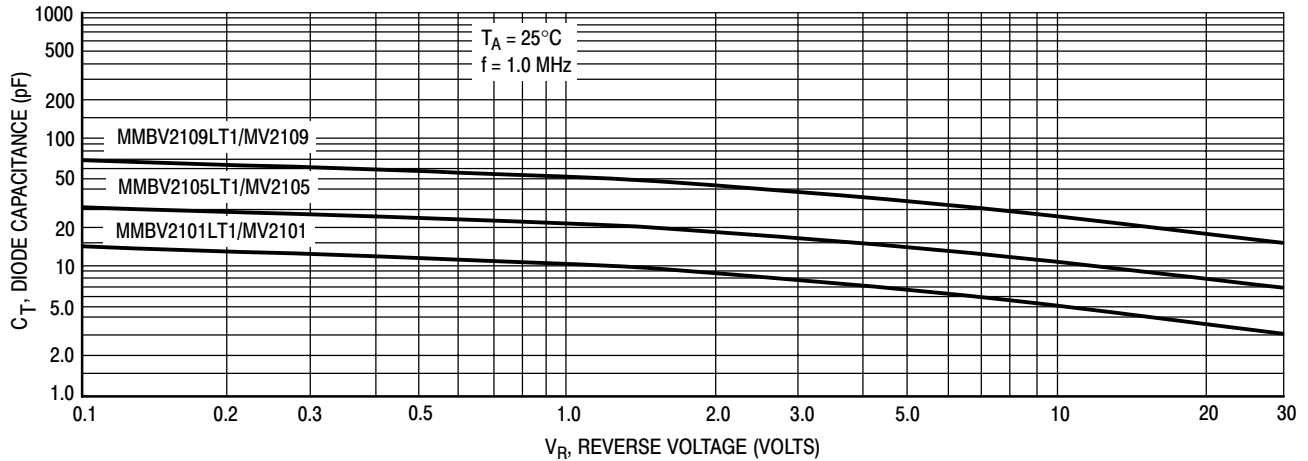

Figure 1. Diode Capacitance versus Reverse Voltage

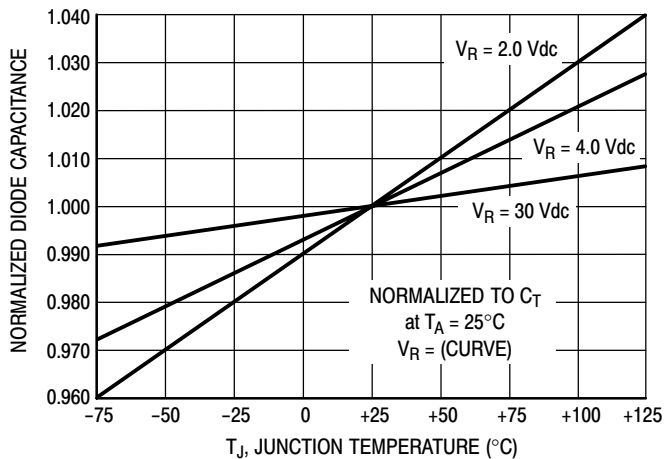

Figure 2. Normalized Diode Capacitance versus Junction Temperature

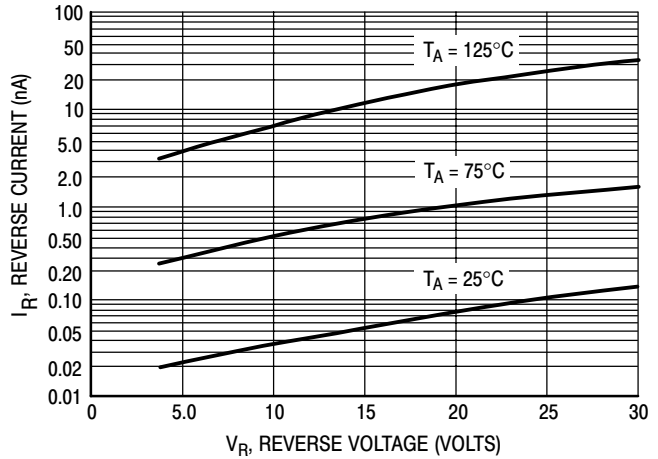

Figure 3. Reverse Current versus Reverse Bias Voltage

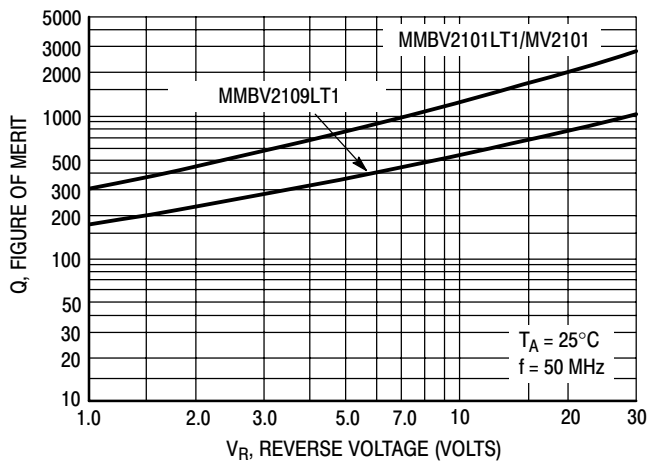

Figure 4. Figure of Merit versus Reverse Voltage

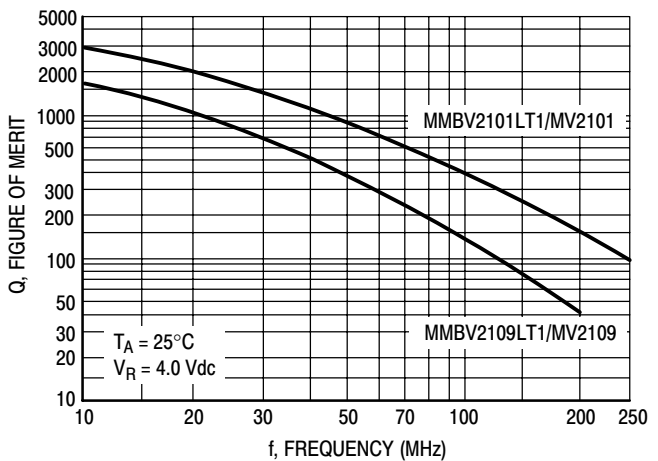

Figure 5. Figure of Merit versus Frequency

# MECHANICAL CASE OUTLINE

## PACKAGE DIMENSIONS

ON Semiconductor®



TO-92 (TO-226)  
CASE 182-06  
ISSUE L

DATE 04/18/1998

SCALE 1:1

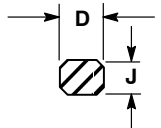
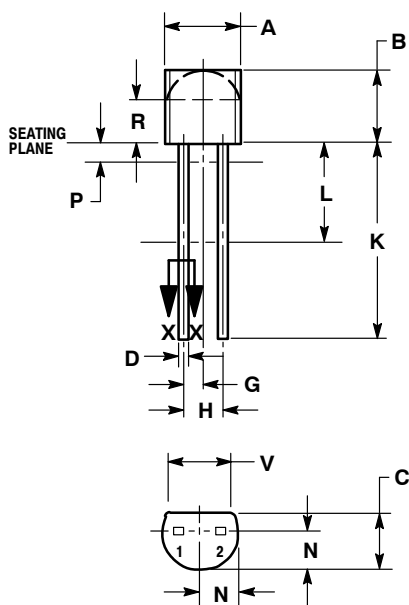

SECTION X-X

NOTES:

1. DIMENSIONING AND TOLERANCING PER ANSI Y14.5M, 1982.
2. CONTROLLING DIMENSION: INCH.
3. CONTOUR OF PACKAGE BEYOND ZONE R IS UNCONTROLLED.
4. LEAD DIMENSION IS UNCONTROLLED IN P AND BEYOND DIMENSION K MINIMUM.

DIM	INCHES		MILLIMETERS	
	MIN	MAX	MIN	MAX
A	0.175	0.205	4.45	5.21
B	0.170	0.210	4.32	5.33
C	0.125	0.165	3.18	4.19
D	0.016	0.021	0.407	0.533
G	0.050 BSC		1.27 BSC	
H	0.100 BSC		2.54 BSC	
J	0.014	0.016	0.36	0.41
K	0.500	---	12.70	---
L	0.250	---	6.35	---
N	0.080	0.105	2.03	2.66
P	---	0.050	---	1.27
R	0.115	---	2.93	---
V	0.135	---	3.43	---

STYLE 1:

- PIN 1. ANODE
- 2. CATHODE

STYLE 2:

- PIN 1. CATHODE
- 2. ANODE

STYLE 3:

- PIN 1. MAIN TERMINAL 1
- 2. MAIN TERMINAL 2

STYLE 4:

CANCELLED

STYLE 5:

- PIN 1. INPUT
- 2. OUTPUT

<b>DOCUMENT NUMBER:</b>	<b>98ASB42118B</b>	Electronic versions are uncontrolled except when accessed directly from the Document Repository. Printed versions are uncontrolled except when stamped "CONTROLLED COPY" in red.
<b>DESCRIPTION:</b>	<b>TO-92 (TO-226)</b>	<b>PAGE 1 OF 1</b>

ON Semiconductor and are trademarks of Semiconductor Components Industries, LLC dba ON Semiconductor or its subsidiaries in the United States and/or other countries. ON Semiconductor reserves the right to make changes without further notice to any products herein. ON Semiconductor makes no warranty, representation or guarantee regarding the suitability of its products for any particular purpose, nor does ON Semiconductor assume any liability arising out of the application or use of any product or circuit, and specifically disclaims any and all liability, including without limitation special, consequential or incidental damages. ON Semiconductor does not convey any license under its patent rights nor the rights of others.

# MECHANICAL CASE OUTLINE

## PACKAGE DIMENSIONS

ON Semiconductor®



**SOT-23 (TO-236)**  
CASE 318-08  
ISSUE AS

DATE 30 JAN 2018

SCALE 4:1



**NOTES:**

1. DIMENSIONING AND TOLERANCING PER ASME Y14.5M, 1994.
2. CONTROLLING DIMENSION: MILLIMETERS.
3. MAXIMUM LEAD THICKNESS INCLUDES LEAD FINISH. MINIMUM LEAD THICKNESS IS THE MINIMUM THICKNESS OF THE BASE MATERIAL.
4. DIMENSIONS D AND E DO NOT INCLUDE MOLD FLASH, PROTRUSIONS, OR GATE BURRS.

DIM	MILLIMETERS			INCHES		
	MIN	NOM	MAX	MIN	NOM	MAX
A	0.89	1.00	1.11	0.035	0.039	0.044
A1	0.01	0.06	0.10	0.000	0.002	0.004
b	0.37	0.44	0.50	0.015	0.017	0.020
c	0.08	0.14	0.20	0.003	0.006	0.008
D	2.80	2.90	3.04	0.110	0.114	0.120
E	1.20	1.30	1.40	0.047	0.051	0.055
e	1.78	1.90	2.04	0.070	0.075	0.080
L	0.30	0.43	0.55	0.012	0.017	0.022
L1	0.35	0.54	0.69	0.014	0.021	0.027
HE	2.10	2.40	2.64	0.083	0.094	0.104
T	0°	---	10°	0°	---	10°

**RECOMMENDED SOLDERING FOOTPRINT**



**GENERIC MARKING DIAGRAM\***



XXX = Specific Device Code  
M = Date Code  
▪ = Pb-Free Package

\*This information is generic. Please refer to device data sheet for actual part marking. Pb-Free indicator, "G" or microdot "▪", may or may not be present.

- |   |   |   |  |
|---|---|---|--|
| STYLE 1 THRU 5:<br>CANCELLED                                | STYLE 6:<br>PIN 1. BASE<br>2. EMITTER<br>3. COLLECTOR       | STYLE 7:<br>PIN 1. EMITTER<br>2. BASE<br>3. COLLECTOR       | STYLE 8:<br>PIN 1. ANODE<br>2. NO CONNECTION<br>3. CATHODE |
| STYLE 9:<br>PIN 1. ANODE<br>2. ANODE<br>3. CATHODE          | STYLE 10:<br>PIN 1. DRAIN<br>2. SOURCE<br>3. GATE           | STYLE 11:<br>PIN 1. ANODE<br>2. CATHODE<br>3. CATHODE-ANODE | STYLE 12:<br>PIN 1. CATHODE<br>2. CATHODE<br>3. ANODE      |
| STYLE 13:<br>PIN 1. SOURCE<br>2. DRAIN<br>3. GATE           | STYLE 14:<br>PIN 1. CATHODE<br>2. GATE<br>3. ANODE          | STYLE 15:<br>PIN 1. GATE<br>2. CATHODE<br>3. ANODE          | STYLE 16:<br>PIN 1. ANODE<br>2. CATHODE<br>3. CATHODE      |
| STYLE 17:<br>PIN 1. NO CONNECTION<br>2. ANODE<br>3. CATHODE | STYLE 18:<br>PIN 1. NO CONNECTION<br>2. CATHODE<br>3. ANODE | STYLE 19:<br>PIN 1. CATHODE<br>2. ANODE<br>3. CATHODE-ANODE | STYLE 20:<br>PIN 1. CATHODE<br>2. ANODE<br>3. GATE         |
| STYLE 21:<br>PIN 1. GATE<br>2. SOURCE<br>3. DRAIN           | STYLE 22:<br>PIN 1. RETURN<br>2. OUTPUT<br>3. INPUT         | STYLE 23:<br>PIN 1. ANODE<br>2. ANODE<br>3. CATHODE         | STYLE 24:<br>PIN 1. GATE<br>2. DRAIN<br>3. SOURCE          |
| STYLE 25:<br>PIN 1. ANODE<br>2. CATHODE<br>3. GATE          | STYLE 26:<br>PIN 1. CATHODE<br>2. ANODE<br>3. NO CONNECTION | STYLE 27:<br>PIN 1. CATHODE<br>2. CATHODE<br>3. CATHODE     | STYLE 28:<br>PIN 1. ANODE<br>2. ANODE<br>3. ANODE          |

<b>DOCUMENT NUMBER:</b>	<b>98ASB42226B</b>	Electronic versions are uncontrolled except when accessed directly from the Document Repository. Printed versions are uncontrolled except when stamped "CONTROLLED COPY" in red.
<b>DESCRIPTION:</b>	<b>SOT-23 (TO-236)</b>	<b>PAGE 1 OF 1</b>

ON Semiconductor and are trademarks of Semiconductor Components Industries, LLC dba ON Semiconductor or its subsidiaries in the United States and/or other countries. ON Semiconductor reserves the right to make changes without further notice to any products herein. ON Semiconductor makes no warranty, representation or guarantee regarding the suitability of its products for any particular purpose, nor does ON Semiconductor assume any liability arising out of the application or use of any product or circuit, and specifically disclaims any and all liability, including without limitation special, consequential or incidental damages. ON Semiconductor does not convey any license under its patent rights nor the rights of others.

**onsemi**, **Onsemi**, and other names, marks, and brands are registered and/or common law trademarks of Semiconductor Components Industries, LLC dba "**onsemi**" or its affiliates and/or subsidiaries in the United States and/or other countries. **onsemi** owns the rights to a number of patents, trademarks, copyrights, trade secrets, and other intellectual property. A listing of **onsemi**'s product/patent coverage may be accessed at [www.onsemi.com/site/pdf/Patent-Marking.pdf](http://www.onsemi.com/site/pdf/Patent-Marking.pdf). **onsemi** reserves the right to make changes at any time to any products or information herein, without notice. The information herein is provided "as-is" and **onsemi** makes no warranty, representation or guarantee regarding the accuracy of the information, product features, availability, functionality, or suitability of its products for any particular purpose, nor does **onsemi** assume any liability arising out of the application or use of any product or circuit, and specifically disclaims any and all liability, including without limitation special, consequential or incidental damages. Buyer is responsible for its products and applications using **onsemi** products, including compliance with all laws, regulations and safety requirements or standards, regardless of any support or applications information provided by **onsemi**. "Typical" parameters which may be provided in **onsemi** data sheets and/or specifications can and do vary in different applications and actual performance may vary over time. All operating parameters, including "Typicals" must be validated for each customer application by customer's technical experts. **onsemi** does not convey any license under any of its intellectual property rights nor the rights of others. **onsemi** products are not designed, intended, or authorized for use as a critical component in life support systems or any FDA Class 3 medical devices or medical devices with a same or similar classification in a foreign jurisdiction or any devices intended for implantation in the human body. Should Buyer purchase or use **onsemi** products for any such unintended or unauthorized application, Buyer shall indemnify and hold **onsemi** and its officers, employees, subsidiaries, affiliates, and distributors harmless against all claims, costs, damages, and expenses, and reasonable attorney fees arising out of, directly or indirectly, any claim of personal injury or death associated with such unintended or unauthorized use, even if such claim alleges that **onsemi** was negligent regarding the design or manufacture of the part. **onsemi** is an Equal Opportunity/Affirmative Action Employer. This literature is subject to all applicable copyright laws and is not for resale in any manner.

## PUBLICATION ORDERING INFORMATION

### LITERATURE FULFILLMENT:

Email Requests to: [orderlit@onsemi.com](mailto:orderlit@onsemi.com)

**onsemi Website:** [www.onsemi.com](http://www.onsemi.com)

### TECHNICAL SUPPORT

**North American Technical Support:**

Voice Mail: 1 800-282-9855 Toll Free USA/Canada

Phone: 011 421 33 790 2910

**Europe, Middle East and Africa Technical Support:**

Phone: 00421 33 790 2910

For additional information, please contact your local Sales Representative