

To our customers,

Old Company Name in Catalogs and Other Documents

On April 1st, 2010, NEC Electronics Corporation merged with Renesas Technology Corporation, and Renesas Electronics Corporation took over all the business of both companies. Therefore, although the old company name remains in this document, it is a valid Renesas Electronics document. We appreciate your understanding.

Renesas Electronics website: <http://www.renesas.com>

April 1st, 2010
Renesas Electronics Corporation

Issued by: Renesas Electronics Corporation (<http://www.renesas.com>)

Send any inquiries to <http://www.renesas.com/inquiry>.

Notice

1. All information included in this document is current as of the date this document is issued. Such information, however, is subject to change without any prior notice. Before purchasing or using any Renesas Electronics products listed herein, please confirm the latest product information with a Renesas Electronics sales office. Also, please pay regular and careful attention to additional and different information to be disclosed by Renesas Electronics such as that disclosed through our website.
2. Renesas Electronics does not assume any liability for infringement of patents, copyrights, or other intellectual property rights of third parties by or arising from the use of Renesas Electronics products or technical information described in this document. No license, express, implied or otherwise, is granted hereby under any patents, copyrights or other intellectual property rights of Renesas Electronics or others.
3. You should not alter, modify, copy, or otherwise misappropriate any Renesas Electronics product, whether in whole or in part.
4. Descriptions of circuits, software and other related information in this document are provided only to illustrate the operation of semiconductor products and application examples. You are fully responsible for the incorporation of these circuits, software, and information in the design of your equipment. Renesas Electronics assumes no responsibility for any losses incurred by you or third parties arising from the use of these circuits, software, or information.
5. When exporting the products or technology described in this document, you should comply with the applicable export control laws and regulations and follow the procedures required by such laws and regulations. You should not use Renesas Electronics products or the technology described in this document for any purpose relating to military applications or use by the military, including but not limited to the development of weapons of mass destruction. Renesas Electronics products and technology may not be used for or incorporated into any products or systems whose manufacture, use, or sale is prohibited under any applicable domestic or foreign laws or regulations.
6. Renesas Electronics has used reasonable care in preparing the information included in this document, but Renesas Electronics does not warrant that such information is error free. Renesas Electronics assumes no liability whatsoever for any damages incurred by you resulting from errors in or omissions from the information included herein.
7. Renesas Electronics products are classified according to the following three quality grades: “Standard”, “High Quality”, and “Specific”. The recommended applications for each Renesas Electronics product depends on the product’s quality grade, as indicated below. You must check the quality grade of each Renesas Electronics product before using it in a particular application. You may not use any Renesas Electronics product for any application categorized as “Specific” without the prior written consent of Renesas Electronics. Further, you may not use any Renesas Electronics product for any application for which it is not intended without the prior written consent of Renesas Electronics. Renesas Electronics shall not be in any way liable for any damages or losses incurred by you or third parties arising from the use of any Renesas Electronics product for an application categorized as “Specific” or for which the product is not intended where you have failed to obtain the prior written consent of Renesas Electronics. The quality grade of each Renesas Electronics product is “Standard” unless otherwise expressly specified in a Renesas Electronics data sheets or data books, etc.
 - “Standard”: Computers; office equipment; communications equipment; test and measurement equipment; audio and visual equipment; home electronic appliances; machine tools; personal electronic equipment; and industrial robots.
 - “High Quality”: Transportation equipment (automobiles, trains, ships, etc.); traffic control systems; anti-disaster systems; anti-crime systems; safety equipment; and medical equipment not specifically designed for life support.
 - “Specific”: Aircraft; aerospace equipment; submersible repeaters; nuclear reactor control systems; medical equipment or systems for life support (e.g. artificial life support devices or systems), surgical implantations, or healthcare intervention (e.g. excision, etc.), and any other applications or purposes that pose a direct threat to human life.
8. You should use the Renesas Electronics products described in this document within the range specified by Renesas Electronics, especially with respect to the maximum rating, operating supply voltage range, movement power voltage range, heat radiation characteristics, installation and other product characteristics. Renesas Electronics shall have no liability for malfunctions or damages arising out of the use of Renesas Electronics products beyond such specified ranges.
9. Although Renesas Electronics endeavors to improve the quality and reliability of its products, semiconductor products have specific characteristics such as the occurrence of failure at a certain rate and malfunctions under certain use conditions. Further, Renesas Electronics products are not subject to radiation resistance design. Please be sure to implement safety measures to guard them against the possibility of physical injury, and injury or damage caused by fire in the event of the failure of a Renesas Electronics product, such as safety design for hardware and software including but not limited to redundancy, fire control and malfunction prevention, appropriate treatment for aging degradation or any other appropriate measures. Because the evaluation of microcomputer software alone is very difficult, please evaluate the safety of the final products or system manufactured by you.
10. Please contact a Renesas Electronics sales office for details as to environmental matters such as the environmental compatibility of each Renesas Electronics product. Please use Renesas Electronics products in compliance with all applicable laws and regulations that regulate the inclusion or use of controlled substances, including without limitation, the EU RoHS Directive. Renesas Electronics assumes no liability for damages or losses occurring as a result of your noncompliance with applicable laws and regulations.
11. This document may not be reproduced or duplicated, in any form, in whole or in part, without prior written consent of Renesas Electronics.
12. Please contact a Renesas Electronics sales office if you have any questions regarding the information contained in this document or Renesas Electronics products, or if you have any other inquiries.

(Note 1) “Renesas Electronics” as used in this document means Renesas Electronics Corporation and also includes its majority-owned subsidiaries.

(Note 2) “Renesas Electronics product(s)” means any product developed or manufactured by or for Renesas Electronics.

**PNP EPITAXIAL SILICON TRANSISTOR
MICROWAVE AMPLIFIER**

FEATURES

- High f_T
 $f_T = 8.5$ GHz TYP.
- High gain
 $|S_{21e}|^2 = 12.0$ dB TYP. @ $f = 1.0$ GHz, $V_{CE} = -8$ V, $I_C = -20$ mA
- High-speed switching characteristics
- Equivalent NPN transistor is the 2SC3583.

ABSOLUTE MAXIMUM RATINGS ($T_A = 25$ °C)

Parameter	Symbol	Rating	Unit
Collector to Base Voltage	V_{CB0}	-20	V
Collector to Emitter Voltage	V_{CE0}	-12	V
Emitter to Base Voltage	V_{EB0}	-3.0	V
Collector Current	I_C	-50	mA
Total Power Dissipation	P_T	200	mW
Junction Temperature	T_j	150	°C
Storage Temperature	T_{stg}	-65 to +150	°C

PACKAGE DIMENSION (in millimeters)

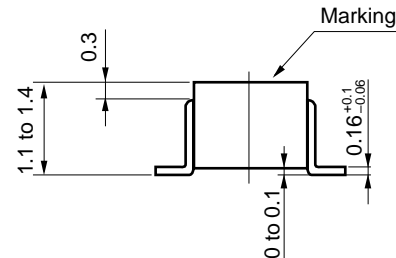
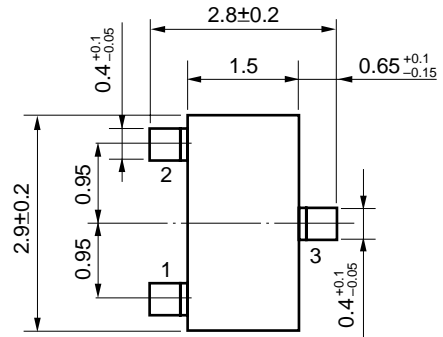

PIN CONNECTIONS

- 1: Emitter
- 2: Base
- 3: Collector
- Marking: T92

ELECTRICAL CHARACTERISTICS ($T_A = 25$ °C)

Parameter	Symbol	Test Conditions	MIN.	TYP.	MAX.	Unit
Collector Cutoff Current	I_{CB0}	$V_{CB} = -10$ V			-0.1	μ A
Emitter Cutoff Current	I_{EB0}	$V_{EB} = -1$ V			-0.1	μ A
DC Current Gain	h_{FE}	$V_{CE} = -8$ V, $I_C = -20$ mA	20		100	
Gain Bandwidth Product	f_T	$V_{CE} = -8$ V, $I_C = -20$ mA, $f = 1$ GHz	6.0	8.5		GHz
Collector Capacitance	C_{re}^*	$V_{CB} = -10$ V, $I_E = 0$, $f = 1$ MHz		0.5	1	pF
Insertion Power Gain	$ S_{21e} ^2$	$V_{CE} = -8$ V, $I_C = -20$ mA, $f = 1.0$ GHz	8.0	12.0		dB
Noise Figure	NF	$V_{CE} = -8$ V, $I_C = -3$ mA, $f = 1$ GHz		1.5	3	dB

* Measured by a 3-terminal bridge. Emitter and Case should be connected to the guard terminal.

h_{FE} Classification

Rank	FB
Marking	T92
h_{FE}	20 to 100

SWITCHING CHARACTERISTICS

Parameter	Symbol	$V_{in} = 1\text{ V}$	Unit
		TYP.	
Turn-on Delay Time	$t_{on}(\text{delay})$	1.08	ns
Rise Time	t_r	0.66	ns
Turn off Delay Time	$t_{off}(\text{delay})$	0.32	ns
Fall Time	t_f	0.78	ns

SWITCHING TIME MEASUREMENT CIRCUIT

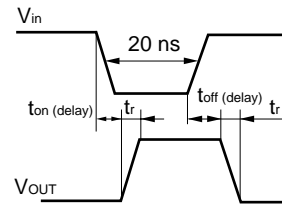
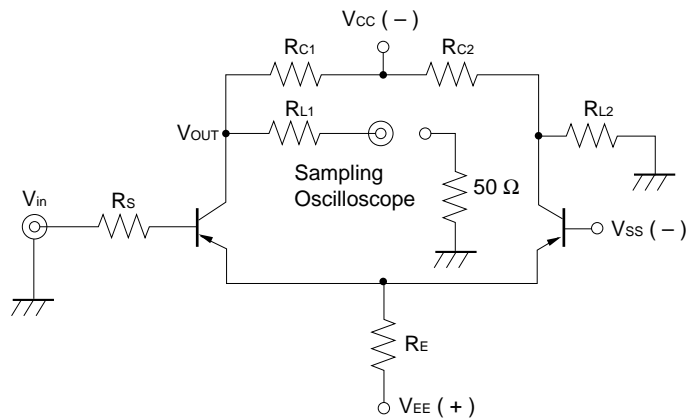

$V_{in} = 1\text{ V}, V_{BB} = -0.5\text{ V}, R_{C1} = R_{C2}$						
R_s	R_C	R_{L1}	R_{L2}	R_E	V_{EE}	V_{CC}
(Ω)	(Ω)	(Ω)	(Ω)	(Ω)	(V)	(V)
160	1 k	200	250	2.7 k	27	26.3

TYPICAL CHARACTERISTICS

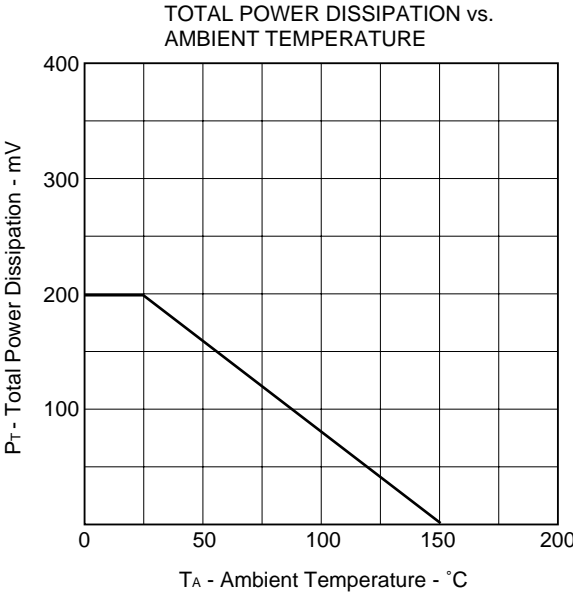

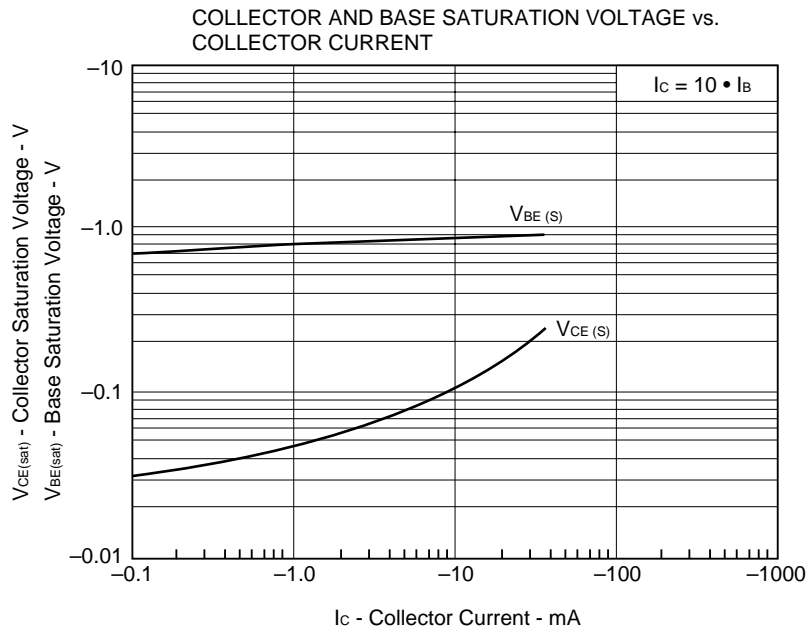
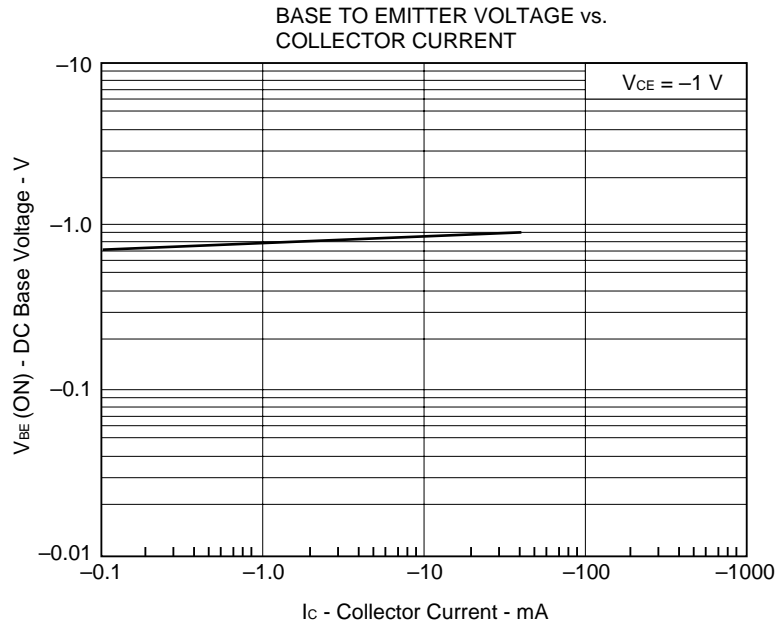

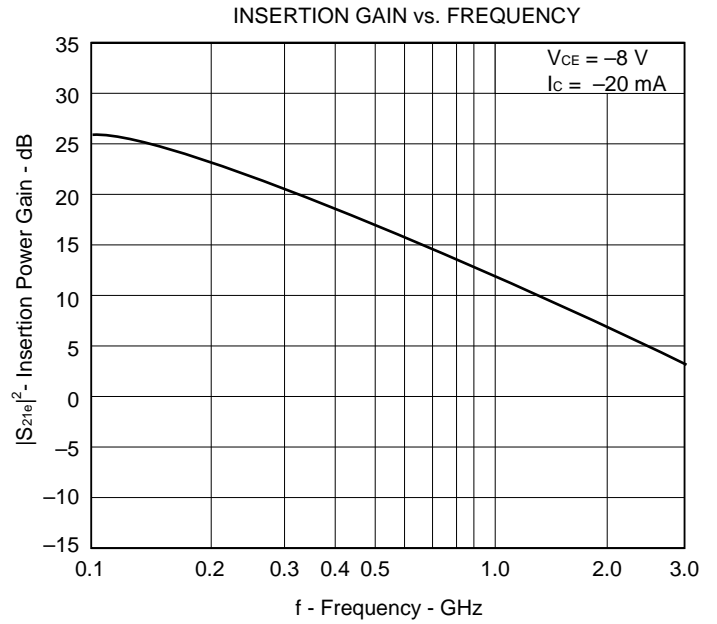
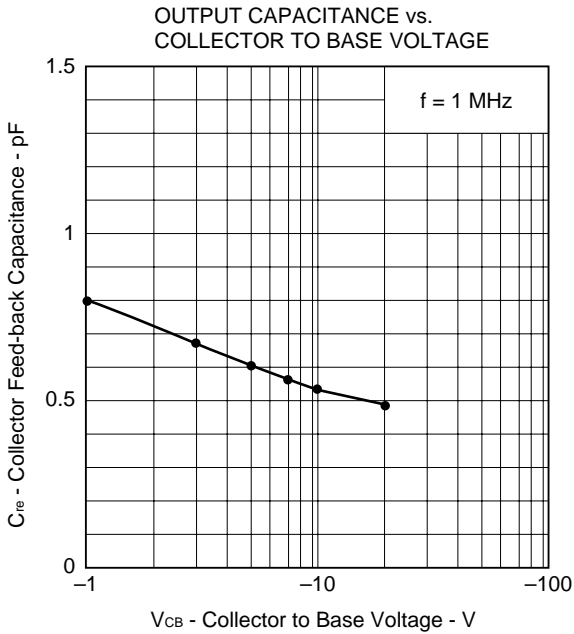
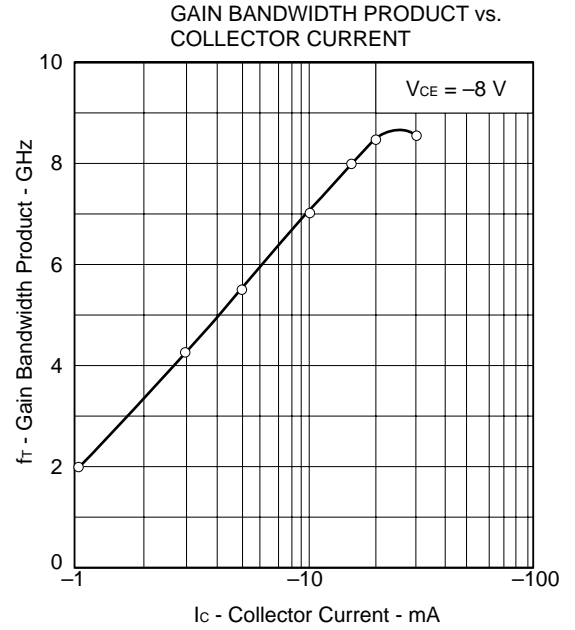
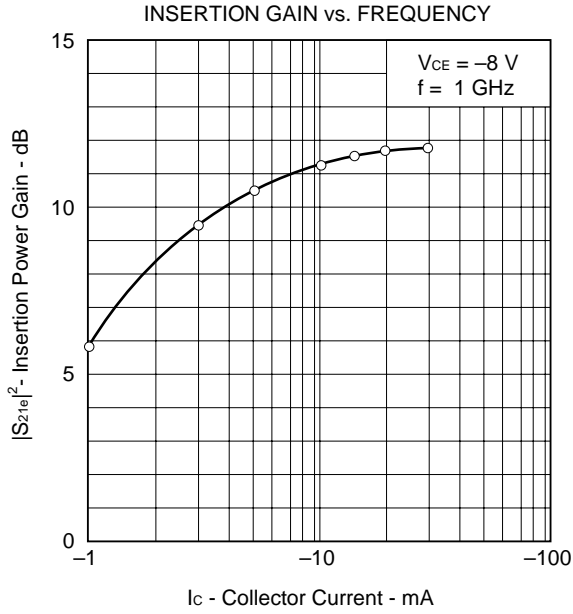

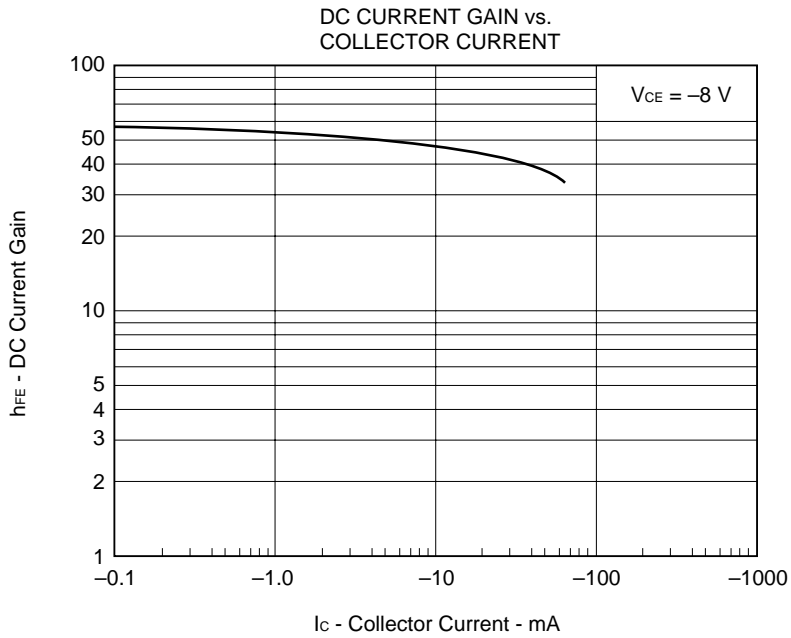
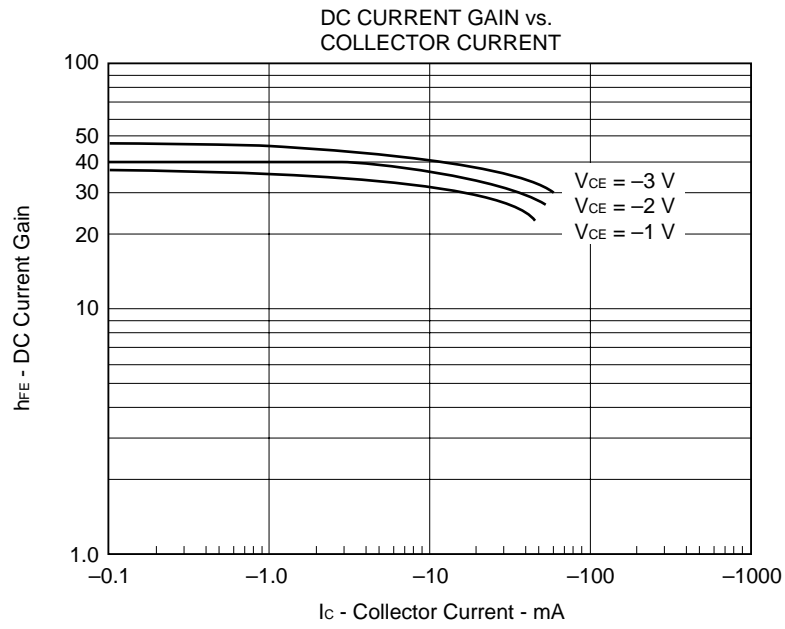

S₁₁

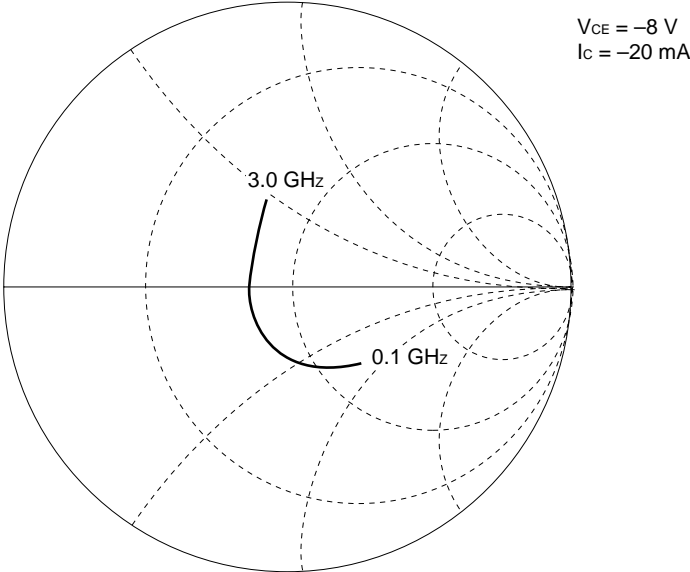

S₂₂

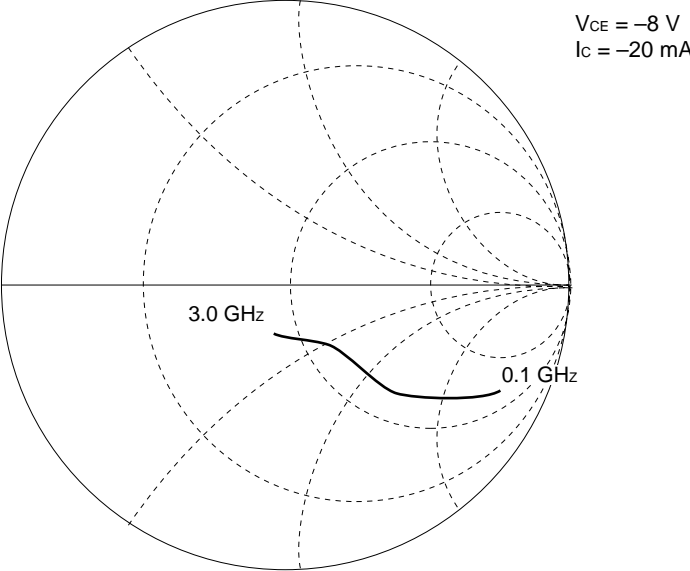

S-PARAMETER

($V_{CE} = 1\text{ V}$, $I_C = 5\text{ mA}$, $Z_o = 50\ \Omega$)

f MHz	S ₁₁		S ₂₁		S ₁₂		S ₂₂	
	MAG	ANG	MAG	ANG	MAG	ANG	MAG	ANG
100	0.553	-43.7	11.03	150.	0.423	71.2	0.666	-25.0
200	0.460	-78.2	8.780	129.	0.691	59.4	0.696	-42.2
300	0.427	-104	7.003	115.	0.857	54.4	0.556	-52.9
400	0.393	-123	5.700	105.	0.983	52.7	0.461	-59.5
500	0.377	-138	4.74	97.6	0.109	52.2	0.392	-64.2
600	0.367	-149	4.053	91.2	0.120	52.5	0.341	-67.4
700	0.362	-159	3.549	85.9	0.131	52.9	0.307	-70.5
800	0.363	-168	3.151	61.3	0.143	53.1	0.280	-73.7
900	0.364	-175	2.847	77.0	0.154	53.8	0.258	-76.1
1000	0.365	178	2.603	73.0	0.165	54.0	0.241	-78.8
1100	0.369	172	2.391	69.3	0.176	54.4	0.227	-82.0
1200	0.375	166	2.219	66.8	0.188	54.2	0.217	-84.8
1300	0.376	162	2.070	62.7	0.200	54.4	0.207	-88.4
1400	0.384	157	1.940	59.4	0.213	54.1	0.200	-92.0
1500	0.391	153	1.838	56.3	0.225	53.8	0.192	-94.9
1600	0.399	149	1.744	53.5	0.238	53.4	0.188	-99.1
1700	0.405	146	1.659	50.8	0.250	52.9	0.184	-102
1800	0.411	142	1.584	48.2	0.264	52.3	0.184	-107
1900	0.418	139	1.520	45.6	0.277	51.7	0.182	-111
2000	0.423	135	1.461	43.1	0.290	51.1	0.181	-115
2100	0.429	132	1.408	40.9	0.302	50.2	0.180	-119
2200	0.438	130	1.361	38.6	0.314	49.4	0.182	-125
2300	0.444	127	1.316	36.4	0.328	48.5	0.181	-128
2400	0.450	124	1.276	34.2	0.341	47.6	0.187	-132
2500	0.457	122	1.239	32.3	0.353	46.5	0.188	-137

S-PARAMETER

($V_{CE} = 3\text{ V}$, $I_C = 5\text{ mA}$, $Z_o = 50\ \Omega$)

f MHz	S ₁₁		S ₂₁		S ₁₂		S ₂₂	
	MAG	ANG	MAG	ANG	MAG	ANG	MAG	ANG
100	0.595	-34.2	11.62	154.	0.0328	74.9	0.902	-19.4
200	0.511	-62.8	9.618	134.	0.0573	64.8	0.760	-33.2
300	0.432	-86.0	7.920	120.	0.0734	58.5	0.633	-41.9
400	0.362	-104	6.575	110.	0.0852	57.1	0.542	-47.3
500	0.345	-119	5.511	102.	0.0964	55.9	0.471	-50.3
600	0.323	-132	4.749	95.9	0.106	56.4	0.420	-52.2
700	0.308	-143	4.177	90.5	0.116	56.6	0.383	-54.1
800	0.300	-153	3.712	85.8	0.126	57.1	0.355	-55.7
900	0.297	-162	3.359	81.5	0.137	57.3	0.332	-57.2
1000	0.295	-170	3.064	77.6	0.147	57.9	0.315	-58.9
1100	0.297	-177	2.818	74.0	0.158	57.9	0.299	-60.6
1200	0.300	176	2.617	70.6	0.169	58.3	0.287	-62.1
1300	0.303	170	2.439	67.4	0.181	58.1	0.276	-64.6
1400	0.308	164	2.284	64.2	0.192	58.1	0.266	-66.5
1500	0.314	160	2.159	61.2	0.203	57.8	0.258	-68.5
1600	0.322	155	2.046	58.4	0.215	57.5	0.250	-71.4
1700	0.328	151	1.944	55.7	0.227	57.3	0.243	-73.6
1800	0.335	147	1.855	53.0	0.240	56.5	0.241	-76.9
1900	0.341	143	1.774	50.5	0.252	56.1	0.233	-80.3
2000	0.349	140	1.705	48.1	0.264	55.5	0.230	-83.1
2100	0.355	136	1.638	45.7	0.276	54.7	0.226	-86.5
2200	0.364	133	1.583	43.5	0.289	54.2	0.222	-90.7
2300	0.372	130	1.53	41.2	0.302	53.2	0.218	-93.6
2400	0.378	128	1.479	39.0	0.314	52.5	0.218	-97.5
2500	0.386	125	1.439	37.0	0.326	51.7	0.215	-101.

S-PARAMETER

($V_{CE} = 8\text{ V}$, $I_C = 5\text{ mA}$, $Z_o = 50\ \Omega$)

f MHz	S ₁₁		S ₂₁		S ₁₂		S ₂₂	
	MAG	ANG	MAG	ANG	MAG	ANG	MAG	ANG
100	0.679	- 27.6	11.75	156.	0.0289	76.9	0.918	- 15.9
200	0.586	- 51.4	10.01	138.	0.0508	66.6	0.802	- 27.7
300	0.491	- 71.0	8.453	124.	0.0670	61.8	0.690	- 35.3
400	0.417	- 87.3	7.152	114.	0.0780	58.9	0.603	- 39.9
500	0.362	- 100	6.040	106.	0.0886	58.3	0.534	- 42.5
600	0.323	- 113	5.245	99.6	0.0984	57.9	0.485	- 44.0
700	0.293	- 124	4.627	94.2	0.107	58.0	0.448	- 45.5
800	0.274	- 135	4.124	89.4	0.117	58.4	0.419	- 46.6
900	0.261	- 145	3.734	85.0	0.126	58.6	0.396	- 47.7
1000	0.251	- 154	3.419	81.2	0.135	59.4	0.377	- 48.8
1100	0.247	- 162	3.150	77.6	0.145	59.6	0.361	- 50.2
1200	0.245	- 170	2.919	74.2	0.155	59.6	0.350	- 51.4
1300	0.245	- 177	2.720	71.0	0.166	59.8	0.339	- 53.2
1400	0.247	175	2.551	67.8	0.176	59.9	0.327	- 54.6
1500	0.251	169	2.410	64.8	0.187	59.7	0.320	- 56.1
1600	0.258	164	2.283	62.1	0.198	59.5	0.311	- 58.2
1700	0.263	159	2.169	59.3	0.209	59.4	0.305	- 59.8
1800	0.269	154	2.067	56.7	0.221	58.9	0.299	- 62.4
1900	0.276	150	1.977	54.4	0.232	58.6	0.292	- 64.9
2000	0.283	146	1.898	51.8	0.243	58.1	0.287	- 67.0
2100	0.290	142	1.824	49.5	0.256	57.5	0.283	- 69.6
2200	0.298	138	1.762	47.2	0.267	57.0	0.277	- 72.9
2300	0.307	135	1.701	44.9	0.279	56.1	0.272	- 75.1
2400	0.314	132	1.645	42.8	0.291	55.4	0.270	- 78.7
2500	0.321	129	1.597	40.6	0.304	54.7	0.264	- 81.3

S-PARAMETER

($V_{CE} = 8\text{ V}$, $I_C = 20\text{ mA}$, $Z_o = 50\ \Omega$)

f MHz	S ₁₁		S ₂₁		S ₁₂		S ₂₂	
	MAG	ANG	MAG	ANG	MAG	ANG	MAG	ANG
100	0.310	- 47.6	20.39	144.	0.0218	77.0	0.798	- 25.2
200	0.243	- 82.1	14.87	123.	0.0375	72.7	0.611	- 37.8
300	0.205	- 107	11.25	111.	0.0514	71.4	0.488	- 43.1
400	0.165	- 125	8.95	102.	0.0643	71.6	0.417	- 45.1
500	0.172	- 140	7.329	96.6	0.0777	71.5	0.365	- 45.7
600	0.169	- 153	6.232	91.6	0.0909	71.5	0.331	- 45.8
700	0.166	- 163	5.414	87.5	0.104	71.0	0.308	- 46.5
800	0.169	- 173	4.778	83.5	0.117	70.6	0.289	- 47.3
900	0.172	179	4.3	80.2	0.130	70.0	0.274	- 47.9
1000	0.176	172	3.902	77.1	0.143	69.3	0.262	- 49.1
1100	0.182	166	3.576	74.1	0.156	68.6	0.251	- 50.4
1200	0.188	160	3.310	71.2	0.169	67.7	0.244	- 51.5
1300	0.194	156	3.080	68.7	0.182	66.7	0.235	- 53.7
1400	0.202	151	2.875	66.0	0.195	66.0	0.227	- 55.6
1500	0.209	147	2.711	63.4	0.208	64.9	0.221	- 57.0
1600	0.217	144	2.564	61.0	0.221	63.9	0.213	- 59.5
1700	0.224	140	2.431	58.6	0.234	62.8	0.209	- 61.7
1800	0.233	137	2.315	56.4	0.247	61.7	0.204	- 64.7
1900	0.240	134	2.212	54.2	0.259	60.8	0.197	- 67.9
2000	0.247	132	2.123	52.0	0.272	59.8	0.193	- 70.0
2100	0.255	129	2.037	49.8	0.284	58.3	0.188	- 73.3
2200	0.263	126	1.965	47.7	0.296	57.2	0.183	- 77.5
2300	0.272	124	1.896	45.7	0.309	56.1	0.179	- 80.1
2400	0.278	122	1.833	43.7	0.321	54.8	0.177	- 84.0
2500	0.286	120	1.778	41.7	0.332	53.7	0.171	- 87.7

No part of this document may be copied or reproduced in any form or by any means without the prior written consent of NEC Corporation. NEC Corporation assumes no responsibility for any errors which may appear in this document.

NEC Corporation does not assume any liability for infringement of patents, copyrights or other intellectual property rights of third parties by or arising from use of a device described herein or any other liability arising from use of such device. No license, either express, implied or otherwise, is granted under any patents, copyrights or other intellectual property rights of NEC Corporation or others.

While NEC Corporation has been making continuous effort to enhance the reliability of its semiconductor devices, the possibility of defects cannot be eliminated entirely. To minimize risks of damage or injury to persons or property arising from a defect in an NEC semiconductor device, customer must incorporate sufficient safety measures in its design, such as redundancy, fire-containment, and anti-failure features.

NEC devices are classified into the following three quality grades:

“Standard”, “Special”, and “Specific”. The Specific quality grade applies only to devices developed based on a customer designated "quality assurance program" for a specific application. The recommended applications of a device depend on its quality grade, as indicated below. Customers must check the quality grade of each device before using it in a particular application.

Standard : Computers, office equipment, communications equipment, test and measurement equipment, audio and visual equipment, home electronic appliances, machine tools, personal electronic equipment and industrial robots

Special: Transportation equipment (automobiles, trains, ships, etc.), traffic control systems, anti-disaster systems, anti-crime systems, safety equipment and medical equipment (not specifically designed for life support)

Specific: Aircrafts, aerospace equipment, submersible repeaters, nuclear reactor control systems, life support systems or medical equipment for life support, etc.

The quality grade of NEC devices in “Standard” unless otherwise specified in NEC's Data Sheets or Data Books.

If customers intend to use NEC devices for applications other than those specified for Standard quality grade, they should contact NEC Sales Representative in advance.

Anti-radioactive design is not implemented in this product.