

17A, 60V, 0.071 Ohm, N-Channel, Logic Level UltraFET Power MOSFETs



Packaging

JEDEC TO-251AA

JEDEC TO-252AA

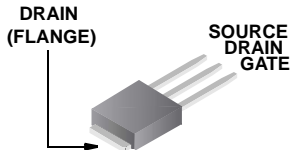

HUFA76409D3

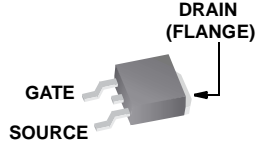

HUFA76409D3S

Symbol

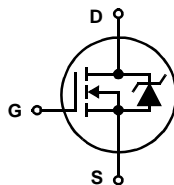

Features

- Ultra Low On-Resistance
 - $r_{DS(ON)} = 0.063\Omega, V_{GS} = 10V$
 - $r_{DS(ON)} = 0.071\Omega, V_{GS} = 5V$
- Simulation Models
 - Temperature Compensated PSPICE® and SABER™ Electrical Models
 - Spice and SABER Thermal Impedance Models
 - www.fairchildsemi.com
- Peak Current vs Pulse Width Curve
- UIS Rating Curve
- Switching Time vs R_{GS} Curves

Ordering Information

| PART NUMBER | PACKAGE | BRAND |
|--------------|----------|--------|
| HUFA76409D3 | TO-251AA | 76409D |
| HUFA76409D3S | TO-252AA | 76409D |

NOTE: When ordering, use the entire part number. Add the suffix T to obtain the TO-252AA variant in tape and reel, e.g., HUFA76409D3ST.

Absolute Maximum Ratings $T_C = 25^\circ C$, Unless Otherwise Specified

| | HUFA76409D3, HUFA76409D3SS | UNITS |
|--|----------------------------|---------------|
| Drain to Source Voltage (Note 1) | V_{DSS} 60 | V |
| Drain to Gate Voltage ($R_{GS} = 20k\Omega$) (Note 1) | V_{DGR} 60 | V |
| Gate to Source Voltage | V_{GS} ± 16 | V |
| Drain Current | | |
| Continuous ($T_C = 25^\circ C, V_{GS} = 5V$) | I_D 17 | A |
| Continuous ($T_C = 25^\circ C, V_{GS} = 10V$) (Figure 2) | I_D 18 | A |
| Continuous ($T_C = 135^\circ C, V_{GS} = 5V$) | I_D 8 | A |
| Continuous ($T_C = 135^\circ C, V_{GS} = 4.5V$) (Figure 2) | I_D 8 | A |
| Pulsed Drain Current | I_{DM} Figure 4 | |
| Pulsed Avalanche Rating | UIS Figures 6, 17, 18 | |
| Power Dissipation | P_D 49 | W |
| Derate Above $25^\circ C$ | 0.327 | W/ $^\circ C$ |
| Operating and Storage Temperature | T_J, T_{STG} -55 to 175 | $^\circ C$ |
| Maximum Temperature for Soldering | | |
| Leads at 0.063in (1.6mm) from Case for 10s. | T_L 300 | $^\circ C$ |
| Package Body for 10s, See Techbrief TB334. | T_{pkg} 260 | $^\circ C$ |

NOTE:

1. $T_J = 25^\circ C$ to $150^\circ C$.

CAUTION: Stresses above those listed in "Absolute Maximum Ratings" may cause permanent damage to the device. This is a stress only rating and operation of the device at these or any other conditions above those indicated in the operational sections of this specification is not implied.

This product has been designed to meet the extreme test conditions and environment demanded by the automotive industry. For a copy of the requirements, see AEC Q101 at: <http://www.aecouncil.com/>

Reliability data can be found at: <http://www.fairchildsemi.com/products/discrete/reliability/index.html>.

All Fairchild semiconductor products are manufactured, assembled and tested under ISO9000 and QS9000 quality systems certification.

HUFA76409D3, HUFA76409D3S

Electrical Specifications $T_C = 25^\circ\text{C}$, Unless Otherwise Specified

| PARAMETER | SYMBOL | TEST CONDITIONS | MIN | TYP | MAX | UNITS | |
|---|-----------------|--|---|-------|-----------|--------------------|----|
| OFF STATE SPECIFICATIONS | | | | | | | |
| Drain to Source Breakdown Voltage | BV_{DSS} | $I_D = 250\mu\text{A}$, $V_{GS} = 0\text{V}$ (Figure 12) | 60 | - | - | V | |
| | | $I_D = 250\mu\text{A}$, $V_{GS} = 0\text{V}$, $T_C = -40^\circ\text{C}$ (Figure 12) | 55 | - | - | V | |
| Zero Gate Voltage Drain Current | I_{DSS} | $V_{DS} = 55\text{V}$, $V_{GS} = 0\text{V}$ | - | - | 1 | μA | |
| | | $V_{DS} = 50\text{V}$, $V_{GS} = 0\text{V}$, $T_C = 150^\circ\text{C}$ | - | - | 250 | μA | |
| Gate to Source Leakage Current | I_{GSS} | $V_{GS} = \pm 16\text{V}$ | - | - | ± 100 | nA | |
| ON STATE SPECIFICATIONS | | | | | | | |
| Gate to Source Threshold Voltage | $V_{GS(TH)}$ | $V_{GS} = V_{DS}$, $I_D = 250\mu\text{A}$ (Figure 11) | 1 | - | 3 | V | |
| Drain to Source On Resistance | $r_{DS(ON)}$ | $I_D = 18\text{A}$, $V_{GS} = 10\text{V}$ (Figures 9, 10) | - | 0.052 | 0.063 | Ω | |
| | | $I_D = 8\text{A}$, $V_{GS} = 5\text{V}$ (Figure 9) | - | 0.060 | 0.071 | Ω | |
| | | $I_D = 8\text{A}$, $V_{GS} = 4.5\text{V}$ (Figure 9) | - | 0.064 | 0.075 | Ω | |
| THERMAL SPECIFICATIONS | | | | | | | |
| Thermal Resistance Junction to Case | $R_{\theta JC}$ | TO-251AA, TO-252AA | - | - | 3.06 | $^\circ\text{C/W}$ | |
| Thermal Resistance Junction to Ambient | $R_{\theta JA}$ | | - | - | 100 | $^\circ\text{C/W}$ | |
| SWITCHING SPECIFICATIONS ($V_{GS} = 4.5\text{V}$) | | | | | | | |
| Turn-On Time | t_{ON} | $V_{DD} = 30\text{V}$, $I_D = 8\text{A}$ $V_{GS} = 4.5\text{V}$, $R_{GS} = 22\Omega$ (Figures 15, 21, 22) | - | - | 153 | ns | |
| Turn-On Delay Time | $t_{d(ON)}$ | | - | 13 | - | ns | |
| Rise Time | t_r | | - | 89 | - | ns | |
| Turn-Off Delay Time | $t_{d(OFF)}$ | | - | 22 | - | ns | |
| Fall Time | t_f | | - | 37 | - | ns | |
| Turn-Off Time | t_{OFF} | | - | - | 89 | ns | |
| SWITCHING SPECIFICATIONS ($V_{GS} = 10\text{V}$) | | | | | | | |
| Turn-On Time | t_{ON} | $V_{DD} = 30\text{V}$, $I_D = 18\text{A}$ $V_{GS} = 10\text{V}$, $R_{GS} = 24\Omega$ (Figures 16, 21, 22) | - | - | 59 | ns | |
| Turn-On Delay Time | $t_{d(ON)}$ | | - | 5.3 | - | ns | |
| Rise Time | t_r | | - | 34 | - | ns | |
| Turn-Off Delay Time | $t_{d(OFF)}$ | | - | 41 | - | ns | |
| Fall Time | t_f | | - | 50 | - | ns | |
| Turn-Off Time | t_{OFF} | | - | - | 136 | ns | |
| GATE CHARGE SPECIFICATIONS | | | | | | | |
| Total Gate Charge | $Q_{g(TOT)}$ | $V_{GS} = 0\text{V}$ to 10V | $V_{DD} = 30\text{V}$, $I_D = 8\text{A}$, $I_{g(REF)} = 1.0\text{mA}$ (Figures 14, 19, 20) | - | 12 | 15 | nC |
| Gate Charge at 5V | $Q_{g(5)}$ | $V_{GS} = 0\text{V}$ to 5V | | - | 6.8 | 8.2 | nC |
| Threshold Gate Charge | $Q_{g(TH)}$ | $V_{GS} = 0\text{V}$ to 1V | | - | 0.54 | 0.65 | nC |
| Gate to Source Gate Charge | Q_{gs} | | | - | 1.7 | - | nC |
| Gate to Drain "Miller" Charge | Q_{gd} | | | - | 3 | - | nC |
| CAPACITANCE SPECIFICATIONS | | | | | | | |
| Input Capacitance | C_{ISS} | $V_{DS} = 25\text{V}$, $V_{GS} = 0\text{V}$, $f = 1\text{MHz}$ (Figure 13) | - | 485 | - | pF | |
| Output Capacitance | C_{OSS} | | - | 130 | - | pF | |
| Reverse Transfer Capacitance | C_{RSS} | | - | 28 | - | pF | |

Source to Drain Diode Specifications

| PARAMETER | SYMBOL | TEST CONDITIONS | MIN | TYP | MAX | UNITS |
|-------------------------------|----------|---|-----|-----|------|-------|
| Source to Drain Diode Voltage | V_{SD} | $I_{SD} = 8\text{A}$ | - | - | 1.25 | V |
| | | $I_{SD} = 4\text{A}$ | - | - | 1.0 | V |
| Reverse Recovery Time | t_{rr} | $I_{SD} = 8\text{A}$, $dI_{SD}/dt = 100\text{A}/\mu\text{s}$ | - | - | 70 | ns |
| Reverse Recovered Charge | Q_{RR} | $I_{SD} = 8\text{A}$, $dI_{SD}/dt = 100\text{A}/\mu\text{s}$ | - | - | 165 | nC |

Typical Performance Curves

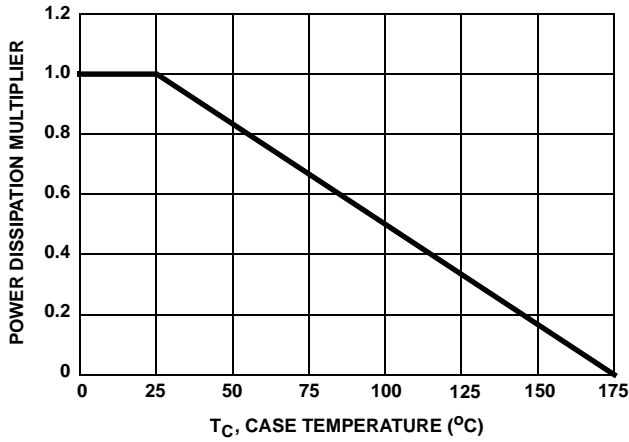

FIGURE 1. NORMALIZED POWER DISSIPATION vs CASE TEMPERATURE

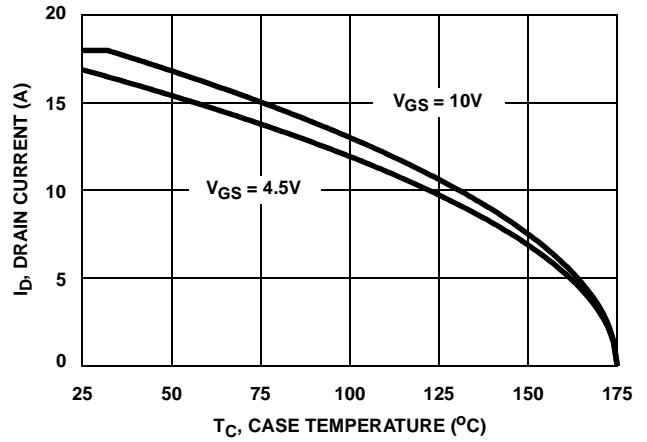

FIGURE 2. MAXIMUM CONTINUOUS DRAIN CURRENT vs CASE TEMPERATURE

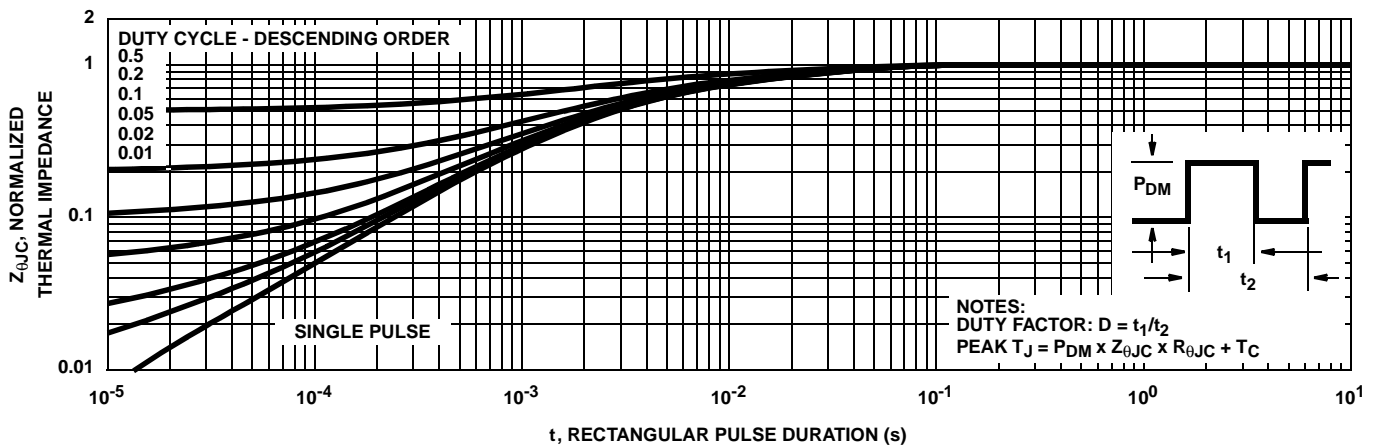

FIGURE 3. NORMALIZED MAXIMUM TRANSIENT THERMAL IMPEDANCE

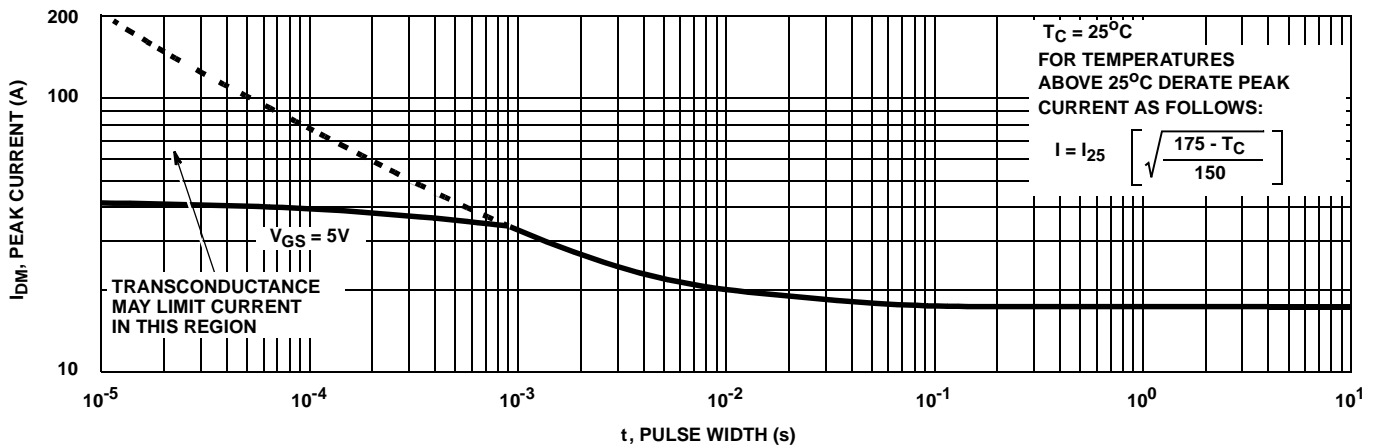

FIGURE 4. PEAK CURRENT CAPABILITY

Typical Performance Curves (Continued)

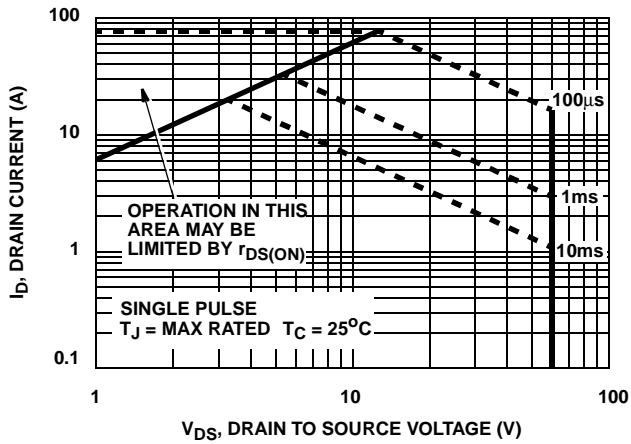
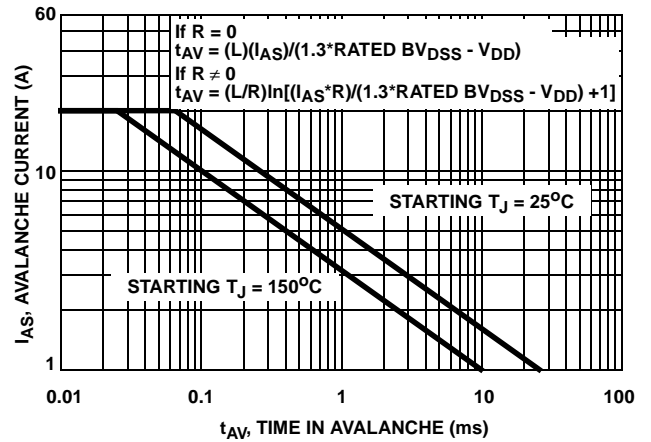

FIGURE 5. FORWARD BIAS SAFE OPERATING AREA



NOTE: Refer to Fairchild Application Notes AN9321 and AN9322.

FIGURE 6. UNCLAMPED INDUCTIVE SWITCHING CAPABILITY

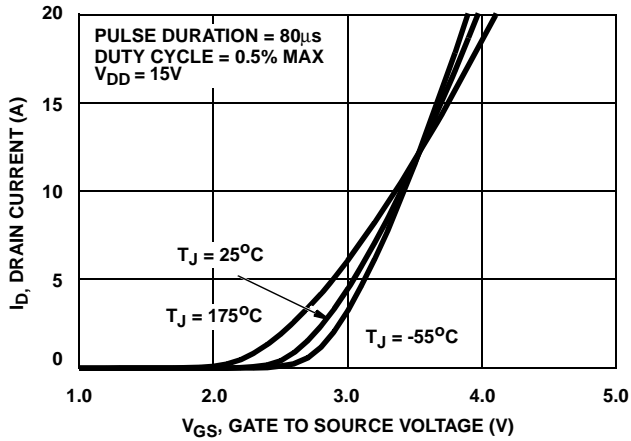

FIGURE 7. TRANSFER CHARACTERISTICS

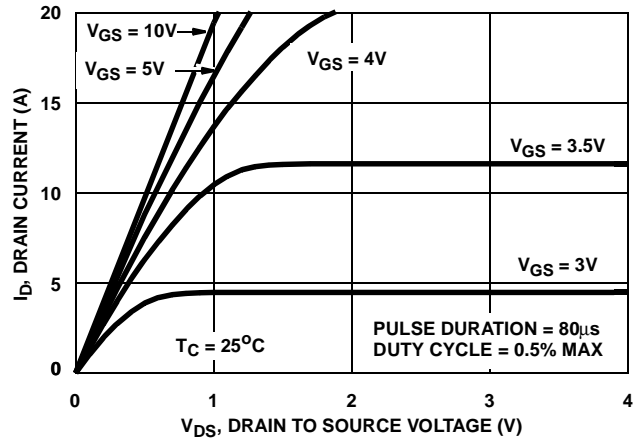

FIGURE 8. SATURATION CHARACTERISTICS

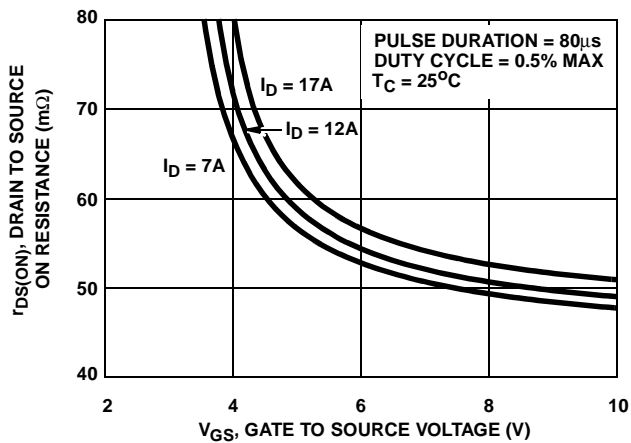

FIGURE 9. DRAIN TO SOURCE ON RESISTANCE vs GATE VOLTAGE AND DRAIN CURRENT

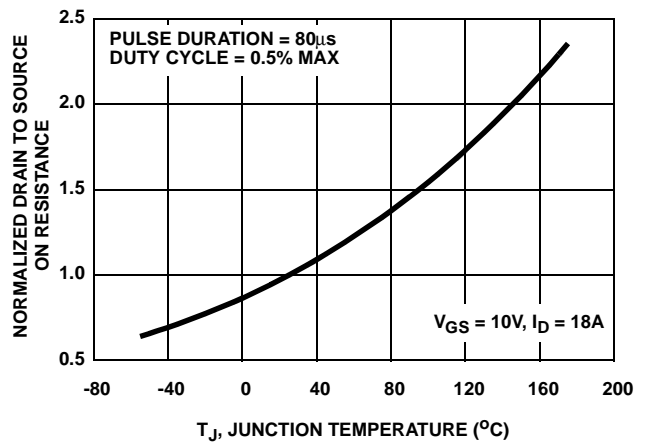

FIGURE 10. NORMALIZED DRAIN TO SOURCE ON RESISTANCE vs JUNCTION TEMPERATURE

Typical Performance Curves (Continued)

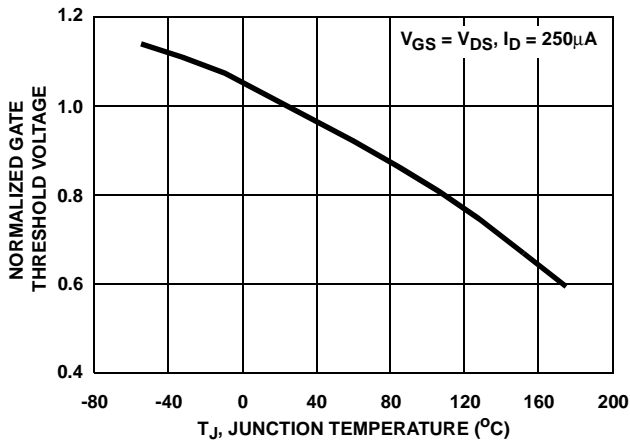

FIGURE 11. NORMALIZED GATE THRESHOLD VOLTAGE vs JUNCTION TEMPERATURE

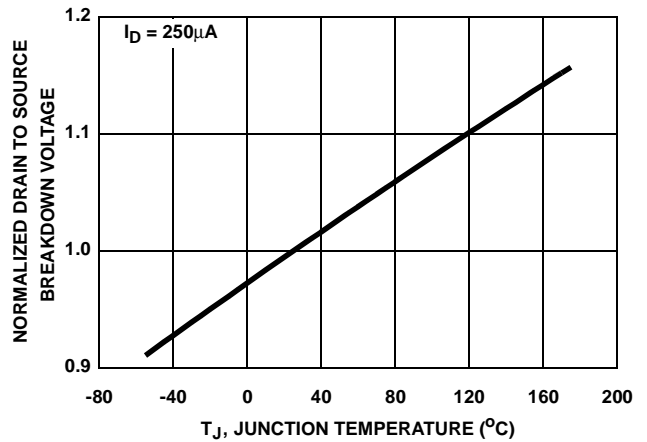

FIGURE 12. NORMALIZED DRAIN TO SOURCE BREAKDOWN VOLTAGE vs JUNCTION TEMPERATURE

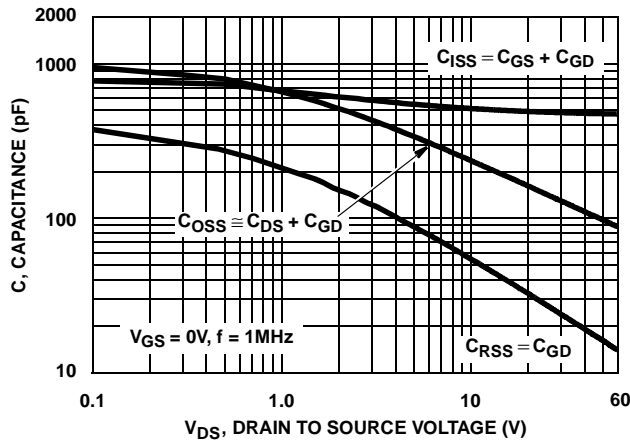
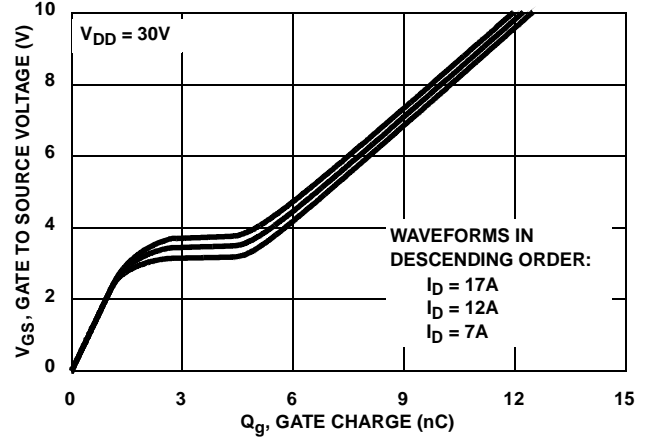

FIGURE 13. CAPACITANCE vs DRAIN TO SOURCE VOLTAGE



NOTE: Refer to Fairchild Application Notes AN7254 and AN7260.

FIGURE 14. GATE CHARGE WAVEFORMS FOR CONSTANT GATE CURRENT

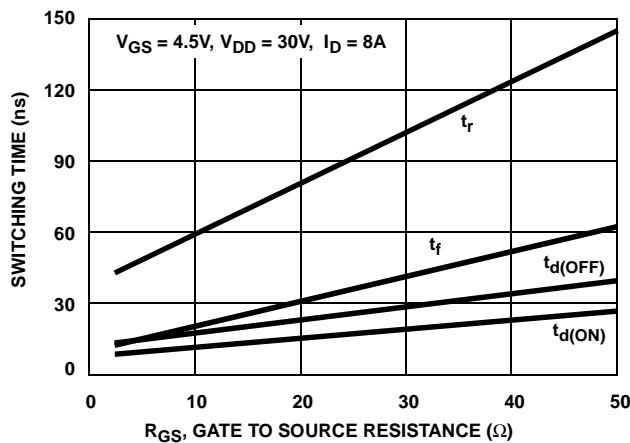

FIGURE 15. SWITCHING TIME vs GATE RESISTANCE

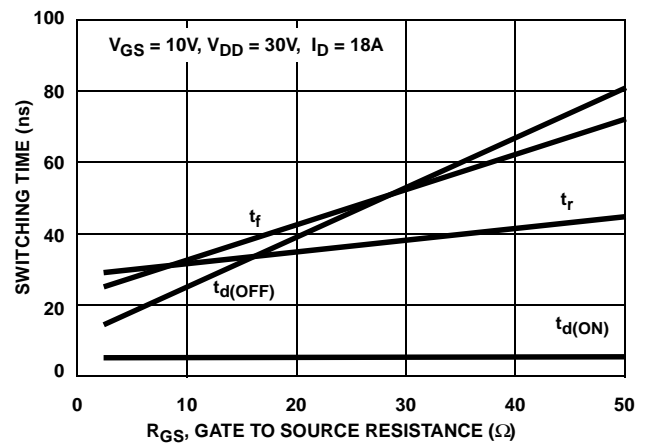

FIGURE 16. SWITCHING TIME vs GATE RESISTANCE

Test Circuits and Waveforms



FIGURE 17. UNCLAMPED ENERGY TEST CIRCUIT



FIGURE 18. UNCLAMPED ENERGY WAVEFORMS



FIGURE 19. GATE CHARGE TEST CIRCUIT

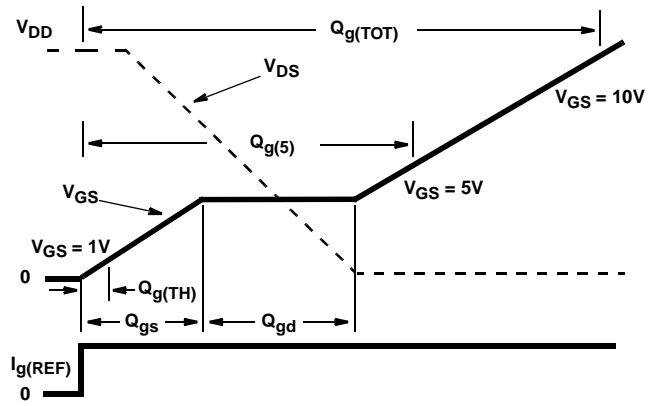

FIGURE 20. GATE CHARGE WAVEFORMS



FIGURE 21. SWITCHING TIME TEST CIRCUIT



FIGURE 22. SWITCHING TIME WAVEFORM

PSPICE Electrical Model

.SUBCKT HUFA76409D 2 1 3 ; rev 23 August 1999

CA 12 8 6.30e-10
 CB 15 14 6.30e-10
 CIN 6 8 4.60e-10

DBODY 7 5 DBODYMOD
 DBREAK 5 11 DBREAKMOD
 DPLCAP 10 5 DPLCAPMOD

EBREAK 11 7 17 18 66.55
 EDS 14 8 5 8 1
 EGS 13 8 6 8 1
 ESG 6 10 6 8 1
 EVTHRES 6 21 19 8 1
 EVTEMP 20 6 18 22 1

IT 8 17 1

LDRAIN 2 5 1.00e-9
 LGATE 1 9 3.73e-9
 LSOURCE 3 7 3.43e-9

MMED 16 6 8 8 MMEDMOD
 MSTRO 16 6 8 8 MSTROMOD
 MWEAK 16 21 8 8 MWEAKMOD

RBREAK 17 18 RBREAKMOD 1
 RDRAIN 50 16 RDRAINMOD 1.88e-2
 RGATE 9 20 3.76
 RLDRAIN 2 5 10
 RLGATE 1 9 37.3
 RLSOURCE 3 7 34.3
 RSLC1 5 51 RSLCMOD 1e-6
 RSLC2 5 50 1e3
 RSOURCE 8 7 RSOURCEMOD 2.40e-2
 RVTHRES 22 8 RVTHRESMOD 1
 RVTEMP 18 19 RVTEMPMOD 1

S1A 6 12 13 8 S1AMOD
 S1B 13 12 13 8 S1BMOD
 S2A 6 15 14 13 S2AMOD
 S2B 13 15 14 13 S2BMOD

VBAT 22 19 DC 1

ESLC 51 50 VALUE={(V(5,51)/ABS(V(5,51)))*(PWR(V(5,51))/(1e-6*43),3)}

.MODEL DBODYMOD D (IS = 3.84e-13 RS = 1.56e-2 TRS1 = -1.0e-3 TRS2 = 7.0e-6 CJO = 6.4e-10 TT = 5.10e-8 XTI = 4.35 M = 0.52)
 .MODEL DBREAKMOD D (RS = 3.70e-1 TRS1 = 9.10e-4 TRS2 = -1e-6)
 .MODEL DPLCAPMOD D (CJO = 3.70e-1 OIS = 1e-3 ON = 10 M = 0.79)
 .MODEL MMEDMOD NMOS (VTO = 2.08 KP = 3.2 IS = 1e-30 N = 10 TOX = 1 L = 1u W = 1u RG = 3.76)
 .MODEL MSTROMOD NMOS (VTO = 2.40 KP = 28 IS = 1e-30 N = 10 TOX = 1 L = 1u W = 1u)
 .MODEL MWEAKMOD NMOS (VTO = 1.80 KP = 0.08 IS = 1e-30 N = 10 TOX = 1 L = 1u W = 1u RG = 37.6 RS = 0.1)
 .MODEL RBREAKMOD RES (TC1 = 1.13e-3 TC2 = -3.00e-7)
 .MODEL RDRAINMOD RES (TC1 = 9.80e-3 TC2 = 2.85e-5)
 .MODEL RSLCMOD RES (TC1 = 5.00e-3 TC2 = 5.05e-6)
 .MODEL RSOURCEMOD RES (TC1 = 1.5e-3 TC2 = 1e-6)
 .MODEL RVTHRESMOD RES (TC1 = -1.48e-3 TC2 = -8.30e-6)
 .MODEL RVTEMPMOD RES (TC1 = -1.68e-3 TC2 = 8e-7)

.MODEL S1AMOD VSWITCH (RON = 1e-5 ROFF = 0.1 VON = -5 VOFF = -2.8)
 .MODEL S1BMOD VSWITCH (RON = 1e-5 ROFF = 0.1 VON = -2.8 VOFF = -5)
 .MODEL S2AMOD VSWITCH (RON = 1e-5 ROFF = 0.1 VON = -0.5 VOFF = 0.5)
 .MODEL S2BMOD VSWITCH (RON = 1e-5 ROFF = 0.1 VON = 0.5 VOFF = -0.5)

.ENDS

NOTE: For further discussion of the PSPICE model, consult **A New PSPICE Sub-Circuit for the Power MOSFET Featuring Global Temperature Options**; IEEE Power Electronics Specialist Conference Records, 1991, written by William J. Hepp and C. Frank Wheatley.

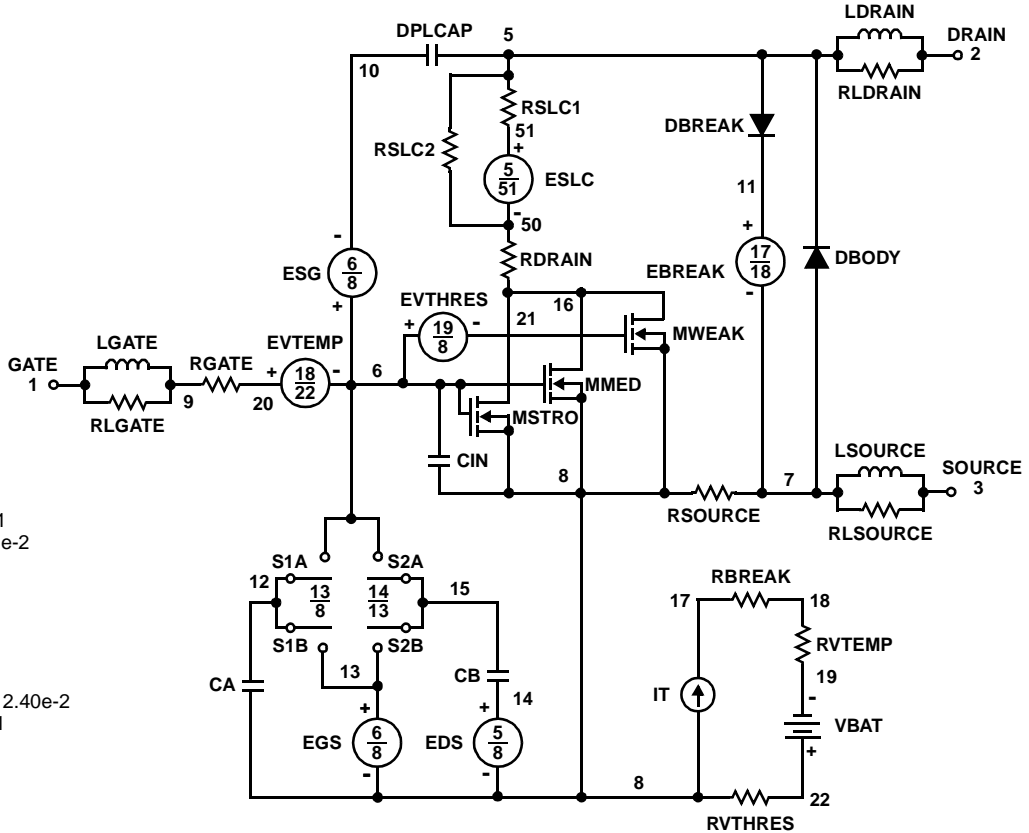

SABER Electrical Model

REV 23 August 1999

template HUFA76409d n2,n1,n3

electrical n2,n1,n3

```
{
var i iscl
d..model dbodymod = (is = 3.84e-13, cjo = 6.40e-10, tt = 5.10e-8, xti = 4.35, m = 0.52)
d..model dbreakmod = ()
d..model dplcapmod = (cjo = 3.70e-10, is = 1e-30, m = 0.79)
m..model mmedmod = (type=_n, vto = 2.08, kp = 3.2, is = 1e-30, tox = 1)
m..model mstrongmod = (type=_n, vto = 2.40, kp = 28, is = 1e-30, tox = 1)
m..model mweakmod = (type=_n, vto = 1.80, kp = 0.08, is = 1e-30, tox = 1)
sw_vcsp..model s1amod = (ron = 1e-5, roff = 0.1, von = -5, voff = -2.8)
sw_vcsp..model s1bmod = (ron = 1e-5, roff = 0.1, von = -2.8, voff = -5)
sw_vcsp..model s2amod = (ron = 1e-5, roff = 0.1, von = -0.5, voff = 0.5)
sw_vcsp..model s2bmod = (ron = 1e-5, roff = 0.1, von = 0.5, voff = -0.5)
```

```
c.ca n12 n8 = 6.30e-10
c.cb n15 n14 = 6.30e-10
c.cin n6 n8 = 4.60e-10
```

```
d.dbody n7 n71 = model=dbodymod
d.dbreak n72 n11 = model=dbreakmod
d.dplcap n10 n5 = model=dplcapmod
```

```
i.it n8 n17 = 1
```

```
l.ldrain n2 n5 = 1.00e-9
l.lgate n1 n9 = 3.73e-9
l.lsource n3 n7 = 3.43e-9
```

```
m.mmed n16 n6 n8 n8 = model=mmedmod, l=1u, w=1u
m.mstrong n16 n6 n8 n8 = model=mstrongmod, l=1u, w=1u
m.mweak n16 n21 n8 n8 = model=mweakmod, l=1u, w=1u
```

```
res.rbreak n17 n18 = 1, tc1 = 1.13e-3, tc2 = -3.00e-7
res.rbody n71 n5 = 1.56e-2, tc1 = -1.0e-3, tc2 = 7.00e-6
res.rdbreak n72 n5 = 3.70e-1, tc1 = 9.10e-4, tc2 = -1e-6
res.rdrain n50 n16 = 1.88e-2, tc1 = 9.80e-3, tc2 = 2.85e-5
res.rgate n9 n20 = 3.76
res.rldrain n2 n5 = 10
res.rlgate n1 n9 = 37.3
res.rlsource n3 n7 = 34.3
res.rslc1 n5 n51 = 1e-6, tc1 = 5.00e-3, tc2 = 5.05e-6
res.rslc2 n5 n50 = 1e3
res.rsource n8 n7 = 2.40e-2, tc1 = 1.5e-3, tc2 = 1e-6
res.rvtemp n18 n19 = 1, tc1 = -1.68e-3, tc2 = 8.00e-7
res.rvthres n22 n8 = 1, tc1 = -1.48e-3, tc2 = -8.30e-6
```

```
spe.ebreak n11 n7 n17 n18 = 66.55
spe.eds n14 n8 n5 n8 = 1
spe.egs n13 n8 n6 n8 = 1
spe.esg n6 n10 n6 n8 = 1
spe.evtemp n20 n6 n18 n22 = 1
spe.evthres n6 n21 n19 n8 = 1
```

```
sw_vcsp.s1a n6 n12 n13 n8 = model=s1amod
sw_vcsp.s1b n13 n12 n13 n8 = model=s1bmod
sw_vcsp.s2a n6 n15 n14 n13 = model=s2amod
sw_vcsp.s2b n13 n15 n14 n13 = model=s2bmod
```

```
v.vbat n22 n19 = dc=1
```

```
equations {
i (n51->n50) +=iscl
iscl: v(n51,n50) = ((v(n5,n51)/(1e-9+abs(v(n5,n51))))*((abs(v(n5,n51))*1e6/43)** 3))
}
}
```

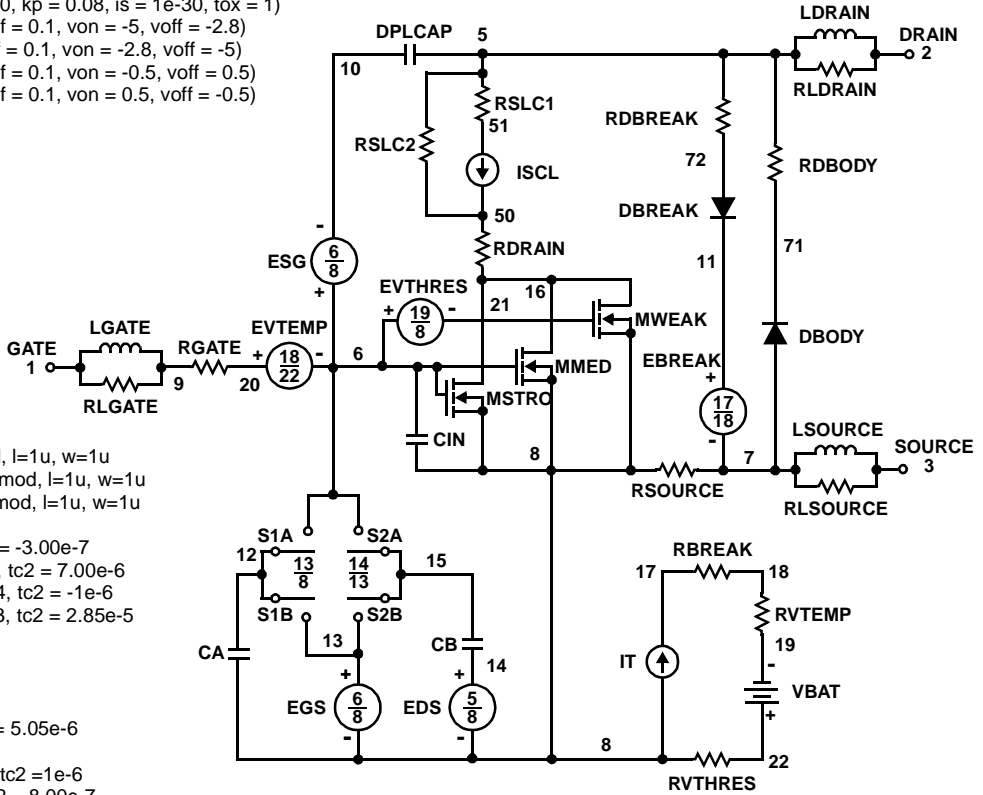

SPICE Thermal Model

REV 10 September 1999

HUFA76409T

CTHERM1 th 6 9.50e-4
 CTHERM2 6 5 2.40e-3
 CTHERM3 5 4 3.90e-3
 CTHERM4 4 3 4.10e-3
 CTHERM5 3 2 5.60e-3
 CTHERM6 2 tl 4.00e-2

RTHERM1 th 6 2.00e-2
 RTHERM2 6 5 1.10e-1
 RTHERM3 5 4 2.75e-1
 RTHERM4 4 3 5.53e-1
 RTHERM5 3 2 7.25e-1
 RTHERM6 2 tl 7.56e-1

SABER Thermal Model

SABER thermal model HUFA76409T

```

template thermal_model th tl
thermal_c th, tl
{
ctherm.ctherm1 th 6 = 9.50e-4
ctherm.ctherm2 6 5 = 2.40e-3
ctherm.ctherm3 5 4 = 3.90e-3
ctherm.ctherm4 4 3 = 4.10e-3
ctherm.ctherm5 3 2 = 5.60e-3
ctherm.ctherm6 2 tl = 4.00e-2

rtherm.rtherm1 th 6 = 2.00e-2
rtherm.rtherm2 6 5 = 1.10e-1
rtherm.rtherm3 5 4 = 2.75e-1
rtherm.rtherm4 4 3 = 5.53e-1
rtherm.rtherm5 3 2 = 7.25e-1
rtherm.rtherm6 2 tl = 7.56e-1
}
    
```

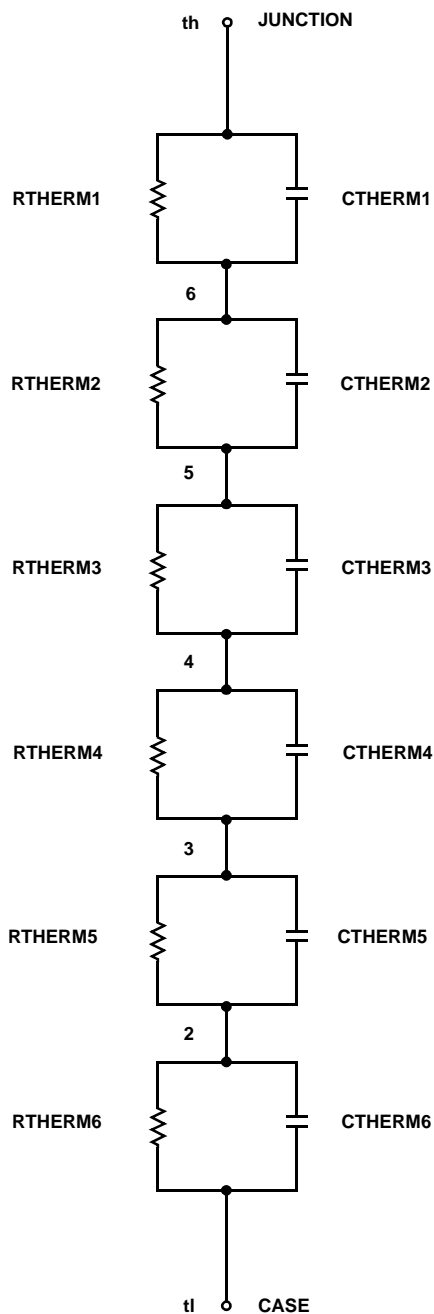

TRADEMARKS

The following are registered and unregistered trademarks Fairchild Semiconductor owns or is authorized to use and is not intended to be an exhaustive list of all such trademarks.

| | | | | |
|-----------------------------------|----------------------------------|----------------------------------|------------------------------|-------------------|
| ACE _x TM | FAST [®] | OPTOLOGIC TM | SMART START TM | VCX TM |
| Bottomless TM | FAST _r TM | OPTOPLANAR TM | STAR*POWER TM | |
| CoolFET TM | FRFET TM | PACMAN TM | Stealth TM | |
| CROSSVOLT TM | GlobalOptoisolator TM | POP TM | SuperSOT TM -3 | |
| DenseTrench TM | GTO TM | Power247 TM | SuperSOT TM -6 | |
| DOMET TM | HiSeC TM | PowerTrench [®] | SuperSOT TM -8 | |
| EcoSPARK TM | ISOPLANAR TM | QFET TM | SyncFET TM | |
| E ² CMOS TM | LittleFET TM | QS TM | TinyLogic TM | |
| EnSigna TM | MicroFET TM | QT Optoelectronics TM | TruTranslation TM | |
| FACT TM | MicroPak TM | Quiet Series TM | UHC TM | |
| FACT Quiet Series TM | MICROWIRE TM | SILENT SWITCHER [®] | UltraFET [®] | |

STAR*POWER is used under license

DISCLAIMER

FAIRCHILD SEMICONDUCTOR RESERVES THE RIGHT TO MAKE CHANGES WITHOUT FURTHER NOTICE TO ANY PRODUCTS HEREIN TO IMPROVE RELIABILITY, FUNCTION OR DESIGN. FAIRCHILD DOES NOT ASSUME ANY LIABILITY ARISING OUT OF THE APPLICATION OR USE OF ANY PRODUCT OR CIRCUIT DESCRIBED HEREIN; NEITHER DOES IT CONVEY ANY LICENSE UNDER ITS PATENT RIGHTS, NOR THE RIGHTS OF OTHERS.

LIFE SUPPORT POLICY

FAIRCHILD'S PRODUCTS ARE NOT AUTHORIZED FOR USE AS CRITICAL COMPONENTS IN LIFE SUPPORT DEVICES OR SYSTEMS WITHOUT THE EXPRESS WRITTEN APPROVAL OF FAIRCHILD SEMICONDUCTOR CORPORATION.

As used herein:

1. Life support devices or systems are devices or systems which, (a) are intended for surgical implant into the body, or (b) support or sustain life, or (c) whose failure to perform when properly used in accordance with instructions for use provided in the labeling, can be reasonably expected to result in significant injury to the user.
2. A critical component is any component of a life support device or system whose failure to perform can be reasonably expected to cause the failure of the life support device or system, or to affect its safety or effectiveness.

PRODUCT STATUS DEFINITIONS

Definition of Terms

| Datasheet Identification | Product Status | Definition |
|--------------------------|------------------------|---|
| Advance Information | Formative or In Design | This datasheet contains the design specifications for product development. Specifications may change in any manner without notice. |
| Preliminary | First Production | This datasheet contains preliminary data, and supplementary data will be published at a later date. Fairchild Semiconductor reserves the right to make changes at any time without notice in order to improve design. |
| No Identification Needed | Full Production | This datasheet contains final specifications. Fairchild Semiconductor reserves the right to make changes at any time without notice in order to improve design. |
| Obsolete | Not In Production | This datasheet contains specifications on a product that has been discontinued by Fairchild semiconductor. The datasheet is printed for reference information only. |