

**1K x 8 Registered PROM**
**Features**

- CMOS for optimum speed/power
- High speed
  - 18 ns address set-up
  - 12 ns clock to output
- Low power
  - 495 mW (commercial)
  - 660 mW (military)
- Synchronous and asynchronous output enables
- On-chip edge-triggered registers
- Programmable asynchronous registers (INIT)
- EPROM technology, 100% programmable

- Slim, 300-mil, 24-pin plastic or hermetic DIP or 28-pin LCC and PLCC
- $5V \pm 10\% V_{CC}$ , commercial and military
- TTL-compatible I/O
- Direct replacement for bipolar PROMs
- Capable of withstanding greater than 2001V static discharge

**Functional Description**

The CY7C235A is a high-performance 1024 word by 8 bit electrically programmable read only memory packaged in a slim 300-mil plastic or hermetic DIP, 28-pin leadless chip carrier, or 28-pin plastic leaded chip carrier. The memory cells

utilize proven EPROM floating gate technology and byte-wide intelligent programming algorithms.

The CY7C235A replaces bipolar devices pin for pin and offers the advantages of lower power, superior performance, and high programming yield. The EPROM cell requires only 12.5V for the super-voltage, and low current requirements allow for gang programming. The EPROM cells allow for each memory location to be tested 100%, as each location is written into, erased, and repeatedly exercised prior to encapsulation. Each PROM is also tested for AC performance to guarantee that the product will meet AC specification limits after customer programming.

4

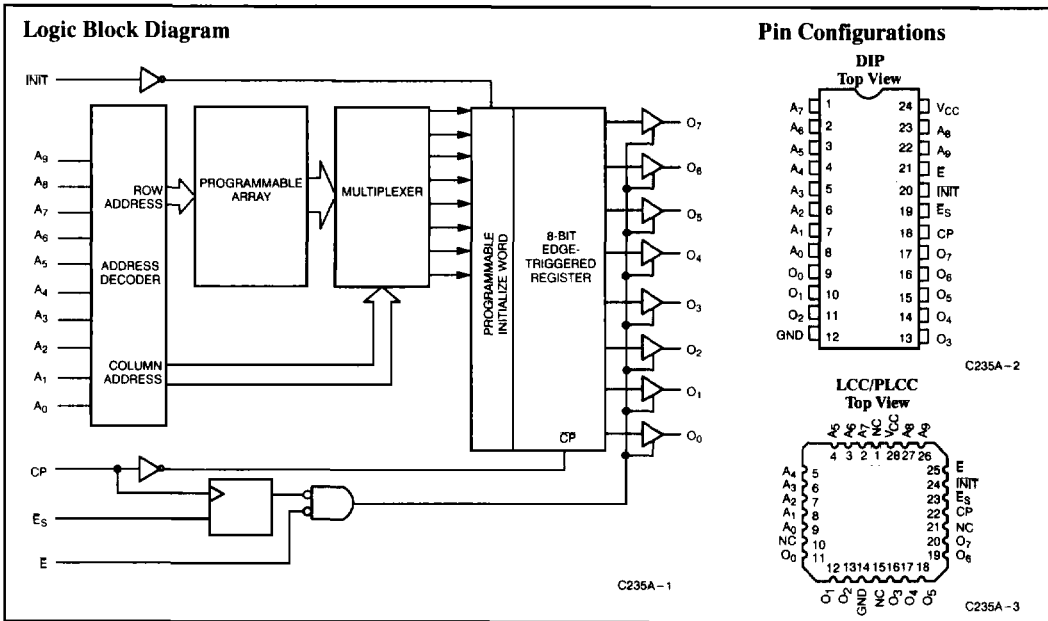
**Selection Guide**

		7C235A-18	7C235A-25	7C235A-30	7C235A-40
Minimum Address Set-Up Time (ns)		18	25	30	40
Maximum Clock to Output (ns)		12	12	15	20
Maximum Operating Current (mA)	Commercial	90	90	90	90
	Military		120	120	120

**Maximum Ratings**

(Above which the useful life may be impaired. For user guidelines, not tested.)

Storage Temperature	-65°C to +150°C
Ambient Temperature with Power Applied	-55°C to +125°C
Supply Voltage to Ground Potential (Pin 24 to Pin 12 for DIP)	-0.5V to +7.0V
DC Voltage Applied to Outputs in High Z State	-0.5V to +7.0V
DC Input Voltage	-3.0V to +7.0V
DC Program Voltage (Pins 7, 18, 20 for DIP)	3.0V

Static Discharge Voltage ..... >2001V  
(per MIL-STD-883, Method 3015)

Latch-Up Current ..... >200 mA

**Operating Range**

Range	Ambient Temperature	V <sub>CC</sub>
Commercial	0°C to +70°C	5V ±10%
Industrial <sup>[1]</sup>	-40°C to +85°C	5V ±10%
Military <sup>[2]</sup>	-55°C to +125°C	5V ±10%

**Electrical Characteristics Over Operating Range<sup>3</sup>**

Parameter	Description	Test Conditions	Min.	Max.	Unit
V <sub>OH</sub>	Output HIGH Voltage	V <sub>CC</sub> = Min., I <sub>OH</sub> = -4.0 mA V <sub>IN</sub> = V <sub>IH</sub> or V <sub>IL</sub>	2.4		V
V <sub>OL</sub>	Output LOW Voltage	V <sub>CC</sub> = Min., I <sub>OL</sub> = 16 mA V <sub>IN</sub> = V <sub>IH</sub> or V <sub>IL</sub>		0.4	V
V <sub>IH</sub>	Input HIGH Level	Guaranteed Input Logical HIGH Voltage for All Inputs <sup>[4]</sup>	2.0		V
V <sub>IL</sub>	Input LOW Level	Guaranteed Input Logical LOW Voltage for All Inputs <sup>[4]</sup>		0.8	V
I <sub>IN</sub>	Input Leakage Current	GND ≤ V <sub>IN</sub> ≤ V <sub>CC</sub>	-10	+10	µA
V <sub>CD</sub>	Input Clamp Diode Voltage	Note 5			
I <sub>OZ</sub>	Output Leakage Current	GND ≤ V <sub>OUT</sub> ≤ V <sub>CC</sub> Output Disabled <sup>[4]</sup>	-10	+10	µA
I <sub>OS</sub>	Output Short Circuit Current	V <sub>CC</sub> = Max., V <sub>OUT</sub> = 0.0V <sup>[6]</sup>	-20	-90	mA
I <sub>CC</sub>	Power Supply Current	I <sub>OUT</sub> = 0 mA, V <sub>CC</sub> = Max.			mA
		Commercial		90	
		Military		120	
V <sub>PP</sub>	Programming Supply Voltage		12	13	V
I <sub>PP</sub>	Programming Supply Current			50	mA
V <sub>IHP</sub>	Input HIGH Programming Voltage		3.0		V
V <sub>ILP</sub>	Input LOW Programming Voltage			0.4	V

**Capacitance<sup>[5]</sup>**

Parameter	Description	Test Conditions	Max.	Unit
C <sub>IN</sub>	Input Capacitance	T <sub>A</sub> = 25°C, f = 1 MHz, V <sub>CC</sub> = 5.0V	10	pF
C <sub>OUT</sub>	Output Capacitance		10	pF

**Notes:**

- Contact a Cypress representative for industrial temperature range specifications.
- T<sub>A</sub> is the "instant on" case temperature.
- See the last page of this specification for Group A subgroup testing information.
- For devices using the synchronous enable, the device must be clocked after applying these voltages to perform this measurement.
- See Introduction to CMOS PROMs in this Data Book for general information on testing.
- For test purposes, not more than one output at a time should be shorted. Short circuit test duration should not exceed 30 seconds.

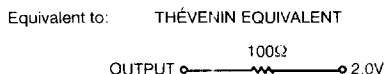
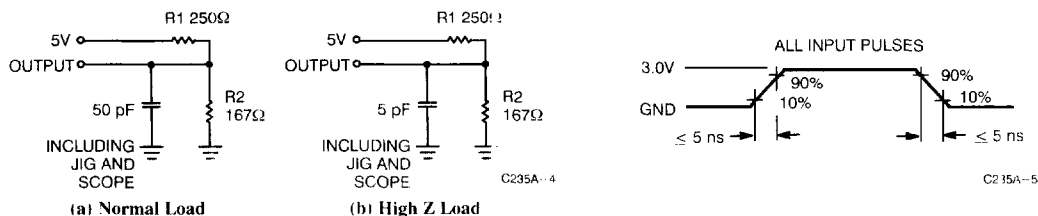
**AC Test Loads and Waveforms<sup>[5]</sup>**

**Operating Modes**

The CY7C235A incorporates a D-type, master-slave register on chip, reducing the cost and size of pipelined microprogrammed systems and applications where accessed PROM data is stored temporarily in a register. Additional flexibility is provided with synchronous ( $\bar{E}_S$ ) and asynchronous ( $\bar{E}$ ) output enables and asynchronous initialization ( $\bar{INIT}$ ).

Upon power-up, the synchronous enable ( $\bar{E}_S$ ) flip-flop will be in the set condition causing the outputs ( $O_0 - O_7$ ) to be in the OFF or high-impedance state. Data is read by applying the memory location to the address input ( $A_0 - A_9$ ) and a logic LOW to the enable ( $\bar{E}_S$ ) input. The stored data is accessed and loaded into the master flip-flops of the data register during the address set up time. At the next LOW-to-HIGH transition of the clock (CP), data is transferred to the slave flip-flops, which drive the output buffers, and the accessed data will appear at the outputs ( $O_0 - O_7$ ), provided the asynchronous enable ( $\bar{E}$ ) is also LOW.

The outputs may be disabled at any time by switching the asynchronous enable ( $\bar{E}$ ) to a logic HIGH, and may be returned to the active state by switching the enable to a logic LOW.

Regardless of the condition of  $\bar{E}$ , the outputs will go to the OFF or high-impedance state upon the next positive clock edge after the synchronous enable ( $\bar{E}_S$ ) input is switched to a HIGH level. If the synchronous enable pin is switched to a logic LOW, the subsequent positive clock edge will return the output to the active state if  $\bar{E}$  is LOW. Following a positive clock edge, the address and synchronous enable inputs are free to change since no change in the output will occur until the next LOW-to-HIGH transition of the clock. This unique feature allows the CY7C235A decoders and sense amplifiers to access the next location while previously addressed data remains stable on the outputs.

System timing is simplified in that the on-chip edge-triggered register allows the PROM clock to be derived directly from the sys-

tem clock without introducing race conditions. The on-chip register timing requirements are similar to those of discrete registers available in the market.

The CY7C235A has an asynchronous initialize input ( $\bar{INIT}$ ). The initialize function is useful during power-up and time-out sequences and can facilitate implementation of other sophisticated functions such as a built-in "jump start" address. When activated the initialize control input causes the contents of a user programmed 1025th 8-bit word to be loaded into the on-chip register. Each bit is programmable and the initialize function can be used to load any desired combination of 1s and 0s into the register. In the unprogrammed state, activating  $\bar{INIT}$  will generate a register CLEAR (all outputs LOW). If all the bits of the initialize word are programmed, activating  $\bar{INIT}$  performs a register PRESET (all outputs HIGH).

Applying a LOW to the  $\bar{INIT}$  input causes an immediate load of the programmed initialize word into the master and slave flip-flops of the register, independent of all other inputs, including the clock (CP). The initialize data will appear at the device outputs after the outputs are enabled by bringing the asynchronous enable ( $\bar{E}$ ) LOW.

When power is applied the (internal) synchronous enable flip-flop will be in a state such that the outputs will be in the high-impedance state. In order to enable the outputs, a clock must occur and the  $\bar{E}_S$  input pin must be LOW at least a set-up time prior to the clock LOW-to-HIGH transition. The  $\bar{E}$  input may then be used to enable the outputs.

When the asynchronous initialize input,  $\bar{INIT}$ , is LOW, the data in the initialize byte will be asynchronously loaded into the output register. It will not, however, appear on the output pins until they are enabled, as described in the preceding paragraph.



Switching Characteristics Over Operating Range<sup>[3, 5]</sup>

Parameter	Description	7C235A-18		7C235A-25		7C235A-30		7C235A-40		Unit
		Min.	Max.	Min.	Max.	Min.	Max.	Min.	Max.	
t <sub>SA</sub>	Address Set-Up to Clock HIGH	18		25		30		40		ns
t <sub>HA</sub>	Address Hold from Clock HIGH	0		0		0		0		ns
t <sub>CO</sub>	Clock HIGH to Valid Output		12		12		15		20	ns
t <sub>PWC</sub>	Clock Pulse Width	12		12		15		20		ns
t <sub>SES</sub>	$\bar{E}_S$ Set-Up to Clock HIGH	10		10		10		15		ns
t <sub>HES</sub>	$\bar{E}_S$ Hold from Clock HIGH	5		5		5		5		ns
t <sub>DI</sub>	Delay from INIT to Valid Output		20		25		25		35	ns
t <sub>RI</sub>	INIT Recovery to Clock HIGH	15		20		20		20		ns
t <sub>PWI</sub>	INIT Pulse Width	15		20		20		25		ns
t <sub>COS</sub>	Inactive to Valid Output from Clock HIGH <sup>[7]</sup>		15		20		20		25	ns
t <sub>HZC</sub>	Inactive Output from Clock HIGH <sup>[7]</sup>		15		20		20		25	ns
t <sub>DOE</sub>	Valid Output from $\bar{E}$ LOW		15		20		20		25	ns
t <sub>HZE</sub>	Inactive Output from $\bar{E}$ HIGH		15		20		20		25	ns

Note:

7. Applies only when the synchronous ( $\bar{E}_S$ ) function is used.

Switching Waveforms<sup>[5]</sup>

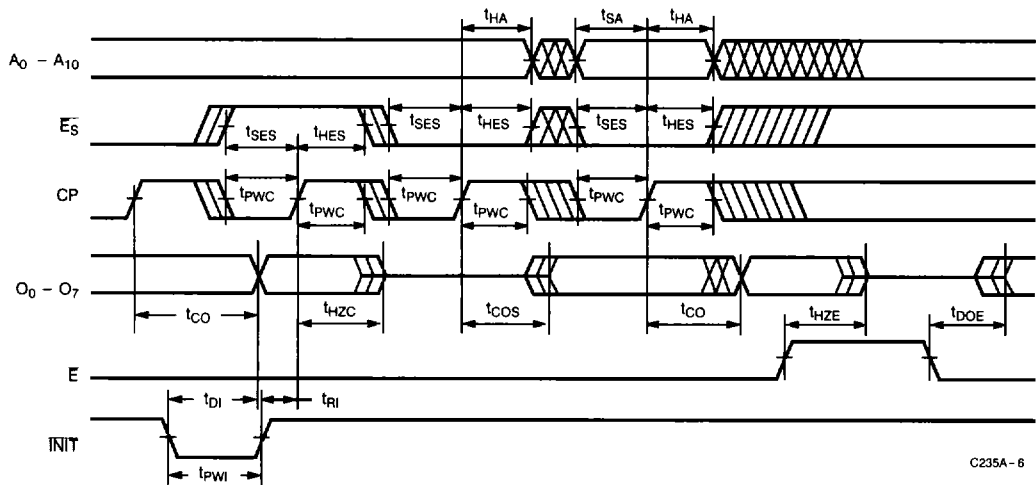

C235A-6

**Programming Information**

Programming support is available from Cypress as well as from a number of third-party software vendors. For detailed programming information, including a listing of software packages, please

see the PROM Programming Information located at the end of this section. Programming algorithms can be obtained from any Cypress representative.

**Table 1. Mode Selection**

Mode	Pin Function <sup>[8]</sup>								
	Read or Output Disable	A <sub>0</sub> , A <sub>3</sub> - A <sub>9</sub>	A <sub>1</sub>	A <sub>2</sub>	CP	$\bar{E}_S$	$\bar{E}$	$\bar{INIT}$	O <sub>7</sub> - O <sub>0</sub>
	Other	A <sub>0</sub> , A <sub>3</sub> - A <sub>9</sub>	A <sub>1</sub>	A <sub>2</sub>	PGM	V <sub>FY</sub>	$\bar{E}$	V <sub>PP</sub>	D <sub>7</sub> - D <sub>0</sub>
Read		A <sub>0</sub> , A <sub>3</sub> - A <sub>9</sub>	A <sub>1</sub>	A <sub>2</sub>	X	V <sub>IL</sub>	V <sub>IL</sub>	V <sub>IH</sub>	O <sub>7</sub> - O <sub>0</sub>
Output Disable		A <sub>0</sub> , A <sub>3</sub> - A <sub>9</sub>	A <sub>1</sub>	A <sub>2</sub>	X	V <sub>IH</sub>	X	V <sub>IH</sub>	High Z
Output Disable		A <sub>0</sub> , A <sub>3</sub> - A <sub>9</sub>	A <sub>1</sub>	A <sub>2</sub>	X	X	V <sub>IH</sub>	V <sub>IH</sub>	High Z
Initialize		A <sub>0</sub> , A <sub>3</sub> - A <sub>9</sub>	A <sub>1</sub>	A <sub>2</sub>	X	X	V <sub>IL</sub>	V <sub>IL</sub>	Init Byte
Program		A <sub>0</sub> , A <sub>3</sub> - A <sub>9</sub>	A <sub>1</sub>	A <sub>2</sub>	V <sub>ILP</sub>	V <sub>IHP</sub>	V <sub>IHP</sub>	V <sub>PP</sub>	D <sub>7</sub> - D <sub>0</sub>
Program Verify		A <sub>0</sub> , A <sub>3</sub> - A <sub>9</sub>	A <sub>1</sub>	A <sub>2</sub>	V <sub>IHP</sub>	V <sub>ILP</sub>	V <sub>IHP</sub>	V <sub>PP</sub>	O <sub>7</sub> - O <sub>0</sub>
Program Inhibit		A <sub>0</sub> , A <sub>3</sub> - A <sub>9</sub>	A <sub>1</sub>	A <sub>2</sub>	V <sub>IHP</sub>	V <sub>IHP</sub>	V <sub>IHP</sub>	V <sub>PP</sub>	High Z
Intelligent Program		A <sub>0</sub> , A <sub>3</sub> - A <sub>9</sub>	A <sub>1</sub>	A <sub>2</sub>	V <sub>ILP</sub>	V <sub>IHP</sub>	V <sub>IHP</sub>	V <sub>PP</sub>	D <sub>7</sub> - D <sub>0</sub>
Program Initialize Byte		A <sub>0</sub> , A <sub>3</sub> - A <sub>9</sub>	V <sub>PP</sub>	V <sub>ILP</sub>	V <sub>ILP</sub>	V <sub>IHP</sub>	V <sub>IHP</sub>	V <sub>PP</sub>	D <sub>7</sub> - D <sub>0</sub>
Blank Check		A <sub>0</sub> , A <sub>3</sub> - A <sub>9</sub>	A <sub>1</sub>	A <sub>2</sub>	V <sub>IHP</sub>	V <sub>ILP</sub>	V <sub>IHP</sub>	V <sub>PP</sub>	Zeros

**Note:**

8. X = "don't care" but not to exceed V<sub>CC</sub> ±5%.

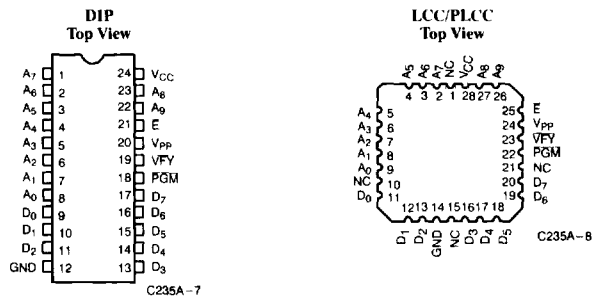
**Figure 1. Programming Pinouts**

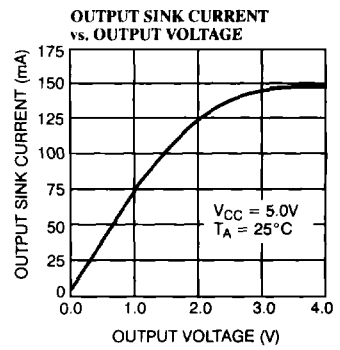
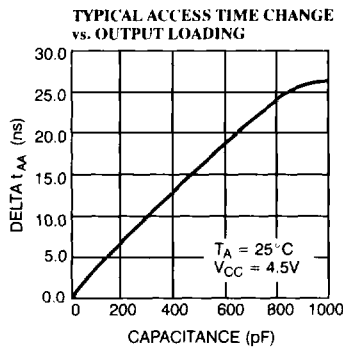
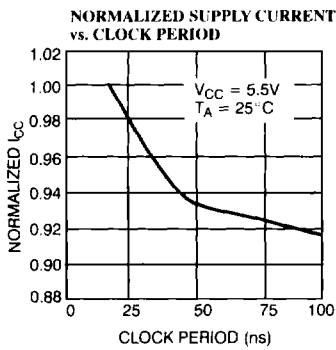
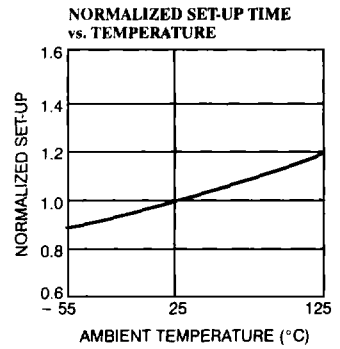
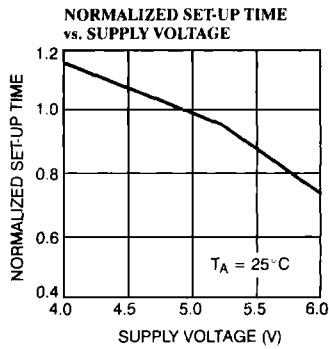
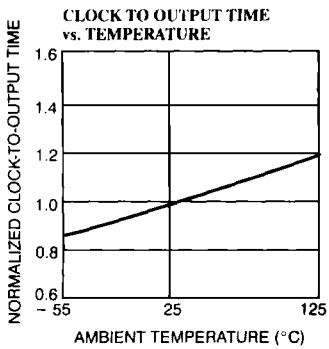
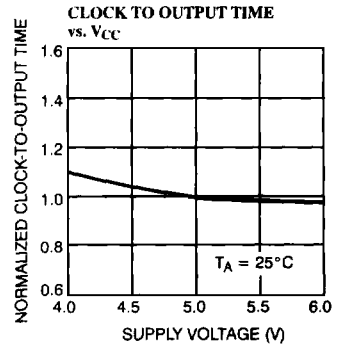
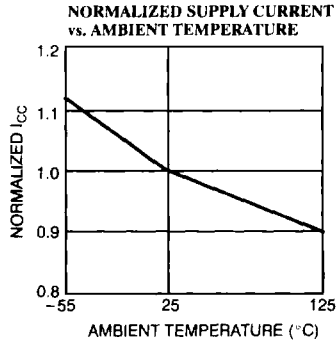
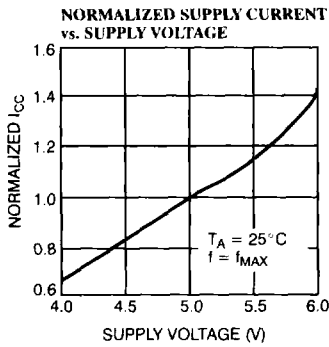
**Typical DC and AC Characteristics**

**Ordering Information<sup>(9)</sup>**

Speed (ns)		Ordering Code	Package Name	Package Type	Operating Range
t <sub>SA</sub>	t <sub>CO</sub>				
18	12	CY7C235A-18DC	D14	24-Lead (300-Mil) CerDIP	Commercial
		CY7C235A-18JC	J64	28-Lead Plastic Leaded Chip Carrier	
		CY7C235A-18PC	P13	24-Lead (300-Mil) Molded DIP	
25	12	CY7C235A-25DC	D14	24-Lead (300-Mil) CerDIP	Commercial
		CY7C235A-25JC	J64	28-Lead Plastic Leaded Chip Carrier	
		CY7C235A-25PC	P13	24-Lead (300-Mil) Molded DIP	
		CY7C235A-25DMB	D14	24-Lead (300-Mil) CerDIP	Military
		CY7C235A-25LMB	L64	28-Square Leadless Chip Carrier	
30	15	CY7C235A-30DC	D14	24-Lead (300-Mil) CerDIP	Commercial
		CY7C235A-30JC	J64	28-Lead Plastic Leaded Chip Carrier	
		CY7C235A-30PC	P13	24-Lead (300-Mil) Molded DIP	
		CY7C235A-30DMB	D14	24-Lead (300-Mil) CerDIP	Military
		CY7C235A-30LMB	L64	28-Square Leadless Chip Carrier	
40	20	CY7C235A-40DC	D14	24-Lead (300-Mil) CerDIP	Commercial
		CY7C235A-40JC	J64	28-Lead Plastic Leaded Chip Carrier	
		CY7C235A-40PC	P13	24-Lead (300-Mil) Molded DIP	
		CY7C235A-40DMB	D14	24-Lead (300-Mil) CerDIP	Military
		CY7C235A-40LMB	L64	28-Square Leadless Chip Carrier	

**Note:**

9. Most of the above products are available in industrial temperature range. Contact a Cypress representative for specifications and product availability.

**MILITARY SPECIFICATIONS  
Group A Subgroup Testing**
**DC Characteristics**

Parameter	Subgroups
V <sub>OH</sub>	1, 2, 3
V <sub>OL</sub>	1, 2, 3
V <sub>IH</sub>	1, 2, 3
V <sub>IL</sub>	1, 2, 3
I <sub>IX</sub>	1, 2, 3
I <sub>OZ</sub>	1, 2, 3
I <sub>CC</sub>	1, 2, 3

**Switching Characteristics**

Parameter	Subgroups
t <sub>SA</sub>	7, 8, 9, 10, 11
t <sub>HA</sub>	7, 8, 9, 10, 11
t <sub>CO</sub>	7, 8, 9, 10, 11

Document #: 38-00229-C