

40097B • 40098B

3-STATE HEX NON-INVERTING AND INVERTING BUFFERS

DESCRIPTION – These two CMOS buffers provide high current output capability suitable for driving high capacitance loads. The 40097B is a Non-Inverting CMOS Buffer with 3-state outputs and the 40098B is an Inverting CMOS Buffer with 3-state outputs. The 3-state outputs of each device are controlled by two Enable Inputs (\overline{EO}_4 , \overline{EO}_2). A HIGH on Enable Input \overline{EO}_4 causes the Outputs of four of the six buffer elements to assume a high impedance or OFF state, regardless of other input conditions and a HIGH on Enable Input \overline{EO}_2 causes the Outputs of the remaining two buffer elements to assume a high impedance or OFF state, regardless of other input conditions.

- 3STATE OUTPUTS
- TTL COMPATIBLE – FAN OUT OF ONE TTL LOAD
- ACTIVE LOW ENABLE INPUTS

PIN NAMES

1A–6A	Buffer Inputs
\overline{EO}_4 , \overline{EO}_2	Enable Inputs (Active LOW)
1X–6X	Buffer Outputs (Active HIGH for the 40097B and Active LOW for the 40098B)

CONNECTION DIAGRAM DIP (TOP VIEW)

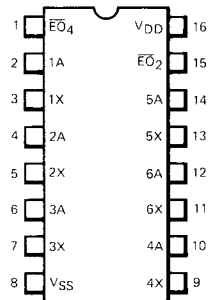

NOTE:
The Flatpak version has the same pinouts (Connection Diagram) as the Dual In-line Package.

40097B LOGIC DIAGRAM

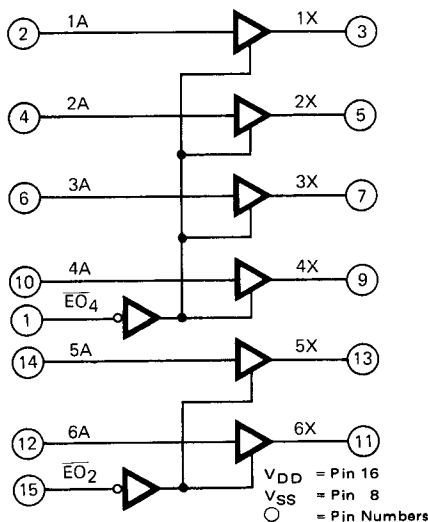

40098B LOGIC DIAGRAM

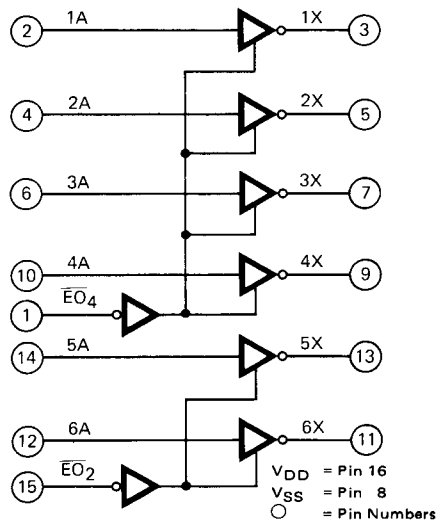

DC CHARACTERISTICS: V_{DD} as shown, $V_{SS} = 0$ V (See Note 1)

SYMBOL	PARAMETER	LIMITS									UNITS	TEMP	TEST CONDITIONS
		$V_{DD} = 5$ V			$V_{DD} = 10$ V			$V_{DD} = 15$ V					
		MIN	TYP	MAX	MIN	TYP	MAX	MIN	TYP	MAX			
I_{OH}	Output HIGH Current	-1.0			-2.0			-3.2			mA	MIN, 25°C	$V_{OUT} = 4.5$ V for $V_{DD} = 5$ V $V_{OUT} = 9.5$ V for $V_{DD} = 10$ V $V_{OUT} = 14.5$ V for $V_{DD} = 15$ V Inputs at V_{SS} or V_{DD} Per Logic Function
		-0.7			-1.4			-2.2				MAX	
I_{OL}	Output LOW Current	2.5			6.25			11.25			mA	MIN, 25°C	$V_{OUT} = 0.4$ V for $V_{DD} = 5$ V $V_{OUT} = 0.5$ V for $V_{DD} = 10$ V $V_{OUT} = 0.5$ V for $V_{DD} = 15$ V Inputs at V_{SS} or V_{DD} Per Logic Function
		1.8			4.5			8.25				MAX	
I_{OZH}	Output OFF Current HIGH	XC								1.6	μ A	MIN, 25°C	Output Returned to V_{DD} , $\bar{E}O_n = V_{DD}$
		XM								0.4		MAX	
I_{OZL}	Output OFF Current LOW	XC								-1.6	μ A	MIN, 25°C	Output Returned to V_{SS} , $\bar{E}O_n = V_{DD}$
		XM								-12		MAX	
I_{DD}	Quiescent Power Supply Current	XC		4		8				16	μ A	MIN, 25°C	All Inputs at 0 V or V_{DD}
		XM		30		60				120		MAX	
				30		60				4		MIN, 25°C	
										120		MAX	

AC CHARACTERISTICS AND SET-UP REQUIREMENTS: V_{DD} as shown, $V_{SS} = 0$ V, $T_A = 25^\circ$ C, 40097B only (See Note 2)

SYMBOL	PARAMETER	LIMITS									UNITS	TEST CONDITIONS
		$V_{DD} = 5$ V			$V_{DD} = 10$ V			$V_{DD} = 15$ V				
		MIN	TYP	MAX	MIN	TYP	MAX	MIN	TYP	MAX		
t_{PLH}	Propagation Delay, Data to Output		65	100		25	40		20	32	ns	$C_L = 50$ pF, $R_L = 200$ k Ω
t_{PHL}			80	100		28	40		20	32		
t_{PZH}	Output Enable Time		70	110		35	55		29	44	ns	$(R_L = 1$ k Ω to V_{SS}) $(R_L = 1$ k Ω to V_{DD})
t_{PZL}			95	150		40	65		30	52		
t_{PHZ}	Output Disable Time		40	65		31	55		29	44	ns	$(R_L = 1$ k Ω to V_{SS}) $(R_L = 1$ k Ω to V_{DD})
t_{PLZ}			60	95		35	55		30	44		
t_{TLH}	Output Transition Time		40	65		25	40		15	30	ns	Input Transition Times ≤ 20 ns
t_{THL}			30	60		15	30		15	30		

Notes on following page.

AC CHARACTERISTICS AND SET-UP REQUIREMENTS: V_{DD} as shown, $V_{SS} = 0$ V, $T_A = 25^\circ\text{C}$, 40098B only (See Note 2)

SYMBOL	PARAMETER	LIMITS									UNITS	TEST CONDITIONS	
		$V_{DD} = 5$ V			$V_{DD} = 10$ V			$V_{DD} = 15$ V					
		MIN	TYP	MAX	MIN	TYP	MAX	MIN	TYP	MAX			
t_{PLH}	Propagation Delay, Data to Output		65	120		30	55		30	44	ns	$C_L = 50$ pF, $R_L = 200$ k Ω	
t_{PHL}			85	155		35	65		30	52			
t_{PZH}	Output Enable Time		70	110		35	55		29	44	ns		$(R_L = 1$ k Ω to V_{SS}) $(R_L = 1$ k Ω to V_{DD})
t_{PZL}			95	170		40	60		30	48			
t_{PHZ}	Outside Disable Time		40	70		31	55		29	44	ns	$(R_L = 1$ k Ω to V_{SS}) $(R_L = 1$ k Ω to V_{DD})	
t_{PLZ}			60	105		35	55		30	44			
t_{TLH}	Output Transition Time		40	65		25	40		15	30	ns		Input Transition Times ≤ 20 ns
t_{THL}			30	60		15	30		15	30			

NOTES:

- Additional DC Characteristics are listed in this section under 4000B Series CMOS Family Characteristics.
- Propagation Delays and Output Transition Times are graphically described in this section under 4000B Series CMOS Family Characteristics.

TYPICAL ELECTRICAL CHARACTERISTICS

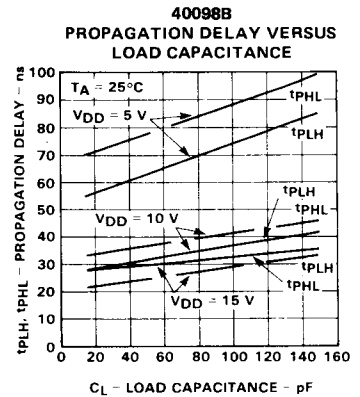
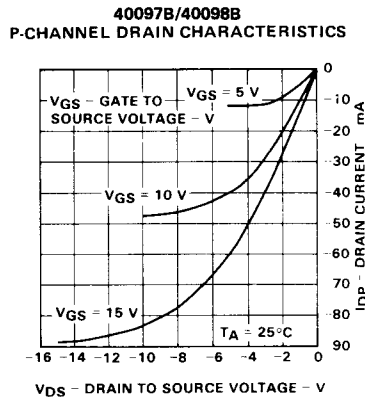
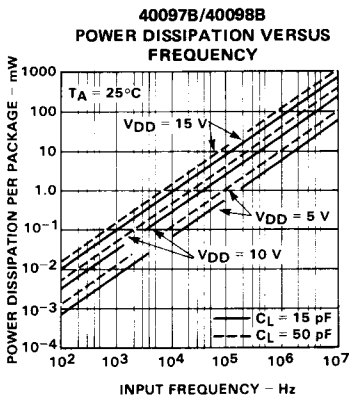

TYPICAL ELECTRICAL CHARACTERISTICS (Cont'd)

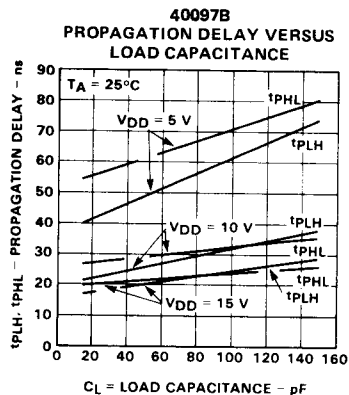
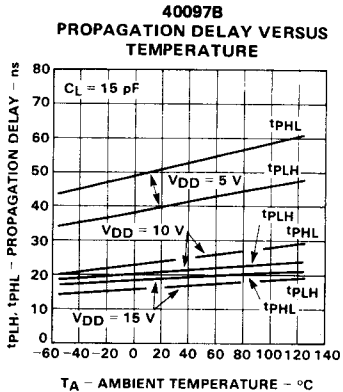
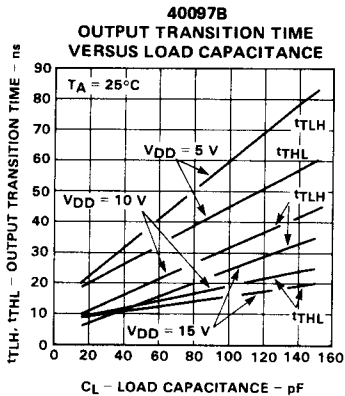
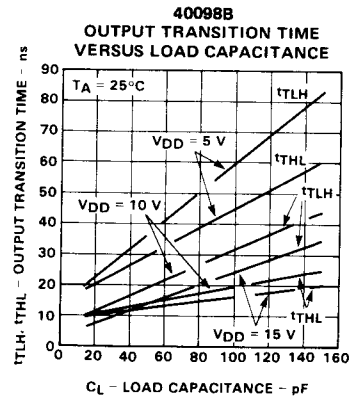
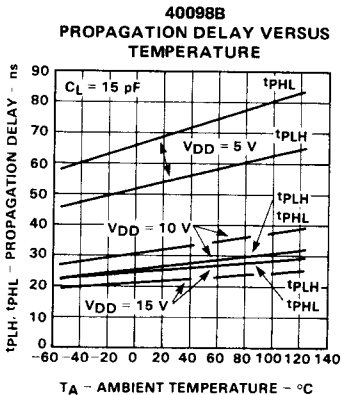
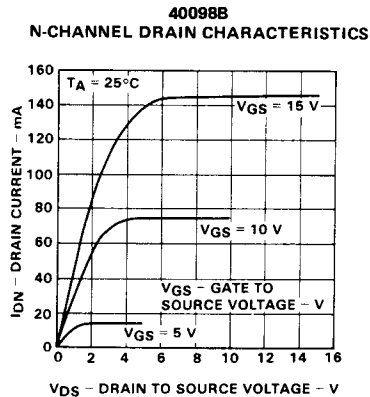

SWITCHING WAVEFORMS

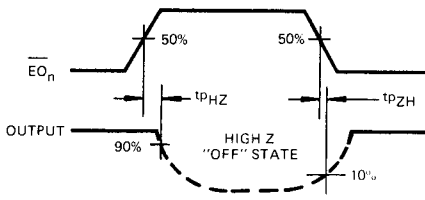

OUTPUT ENABLE TIME (t_{pZH}) AND OUTPUT DISABLE TIME (t_{pHZ})

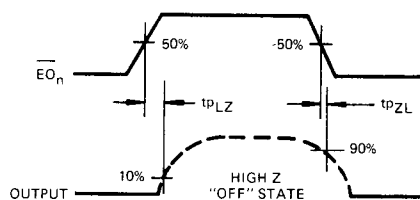

OUTPUT ENABLE TIME (t_{pZL}) AND OUTPUT DISABLE TIME (t_{pLZ})