

National Semiconductor is now part of
Texas Instruments.

Search <http://www.ti.com/> for the latest technical
information and details on our current products and services.

LMV1088

Dual Input, Far Field Noise Suppression Microphone Amplifier with Automatic Calibration Ability

General Description

The LMV1088 amplifies near-field voice signals within 4cm of the microphones while rejecting far-field acoustic noise greater than 0.5m from the microphones. Up to 20dB of far-field rejection is possible in a properly configured and calibrated system.

Part of the Powerwise® family of energy efficient solutions, the LMV1088 consumes 1mA of supply current while providing superior performance to DSP solutions consuming over 10 times the power.

A fast calibration during the manufacturing test process allows the LMV1088 to compensate the entire microphone system. This calibration includes mismatch in microphone gain and frequency response, as well as acoustical path variances. The LMV1088 stores the calibration coefficients in on-board EEPROM. The calibration is initiated by I2C command or by pin control.

The dual microphone inputs are differential to provide excellent noise immunity. The microphones are biased with an internal low-noise bias supply.

Key Specifications

(3.3V supply, unless otherwise specified)

■ Supply voltage	2.7V to 5.5V
■ Supply current	1mA (typ)
■ Signal to noise ratio (A-weighted)	60dB (typ)
■ Total harmonic distortion	0.1% (typ)
■ Noise cancellation	20dB (typ)
■ PSRR	85dB (typ)

Features

- Low power consumption
- No added processing delay
- Automatic Calibration
- Space-saving 36 Bump micro SMD package
- Up to 20dB SNRI

Applications

- Mobile handsets
- Mobile and handheld two-way radios
- Bluetooth and other powered headsets
- Hand-held voice microphones
- Portable public address systems

Application of the LMV1088

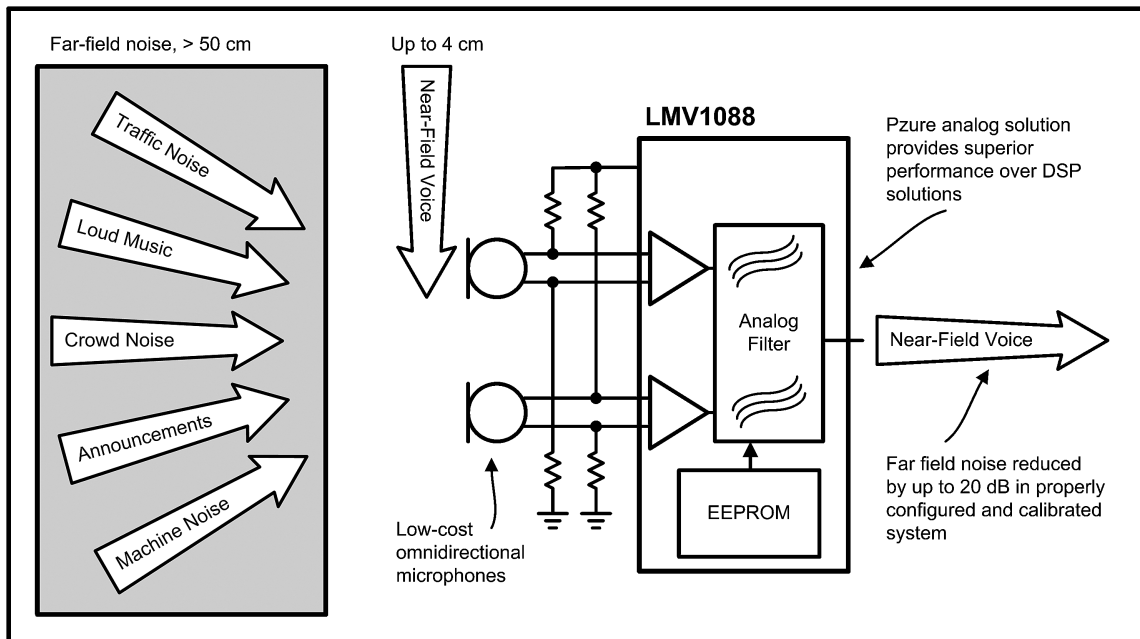

20213029

Typical Application

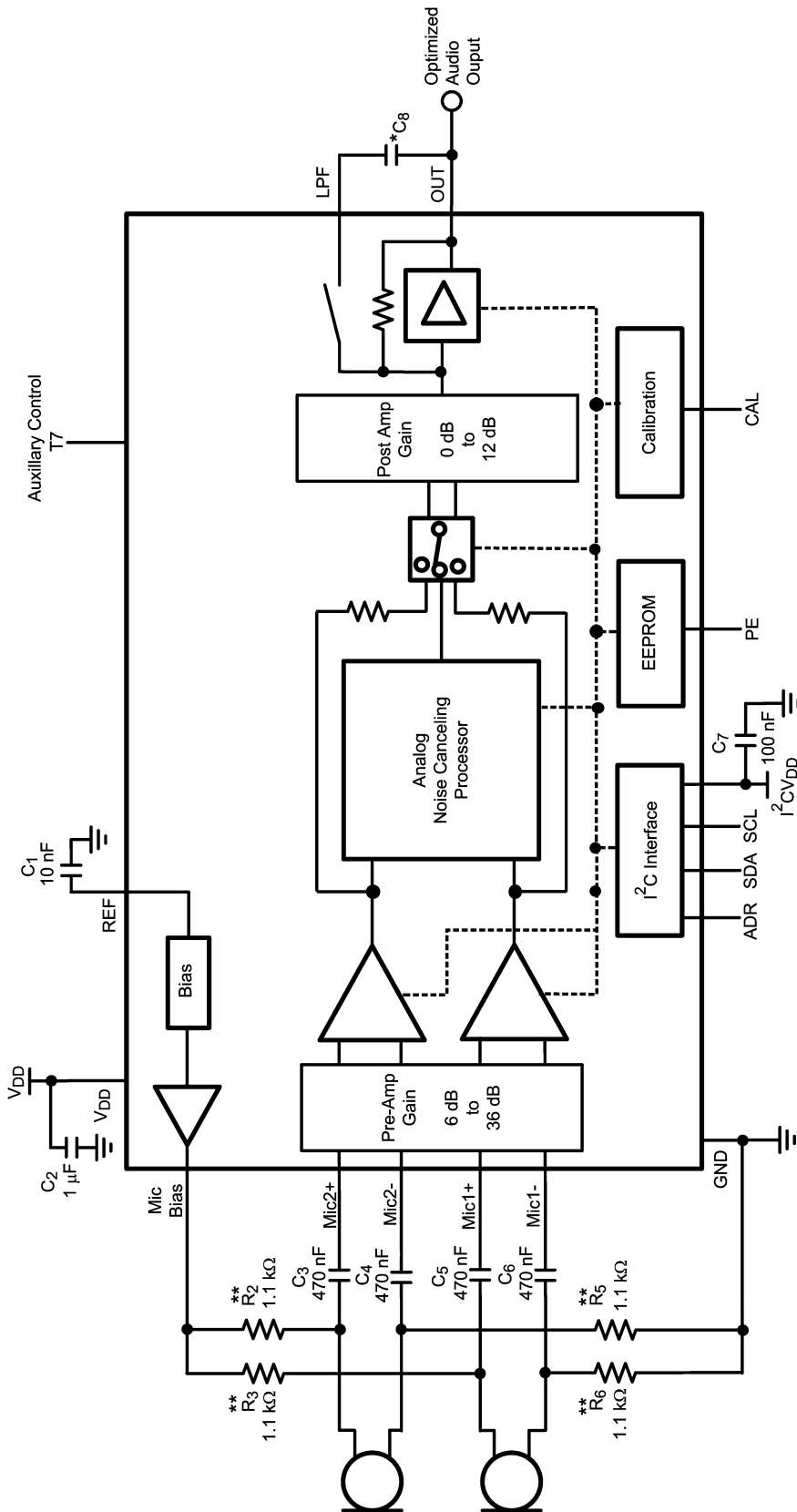

* The value of the low pass filter capacitor is application dependent, see the application section for additional information.
 ** The value of the microphone resistors is a standard value often used for electric microphones.

20213041

FIGURE 1. Typical Dual Microphone Far Field noise Cancelling Application

Connection Diagrams

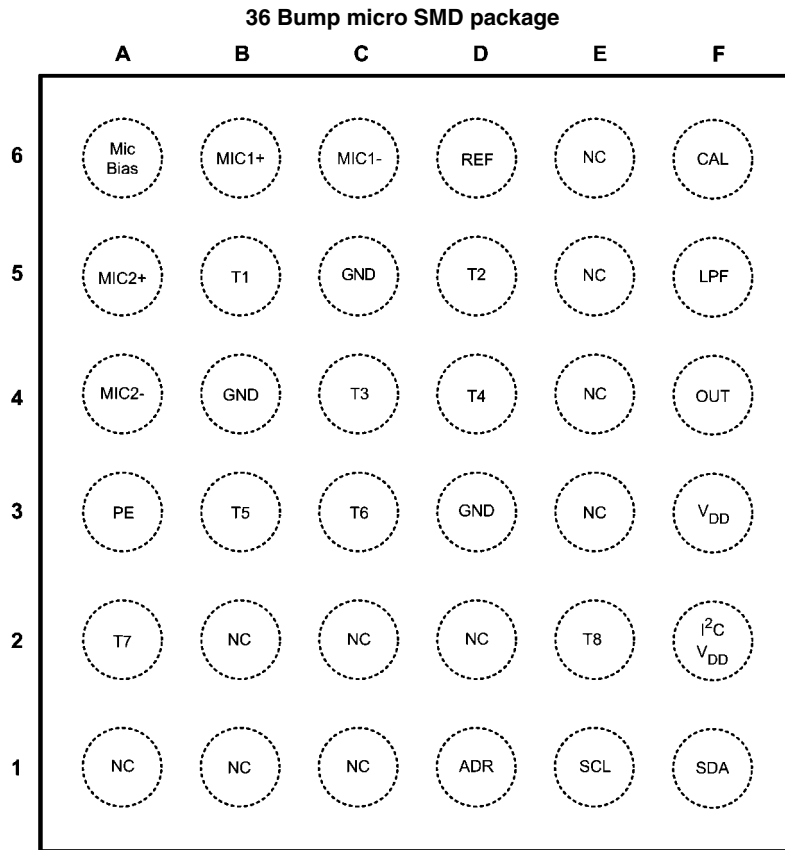

20213030

Top View
Order Number LMV1088RL
See NS Package Number RLA36TTA

36 Bump micro SMD Marking

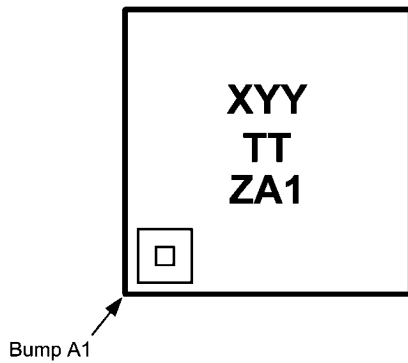

20213031

Top View
X = Plant Code
YY = Date Code
TT = Die Tracability
ZA1 = LMV1088RL

micro SMD Package View

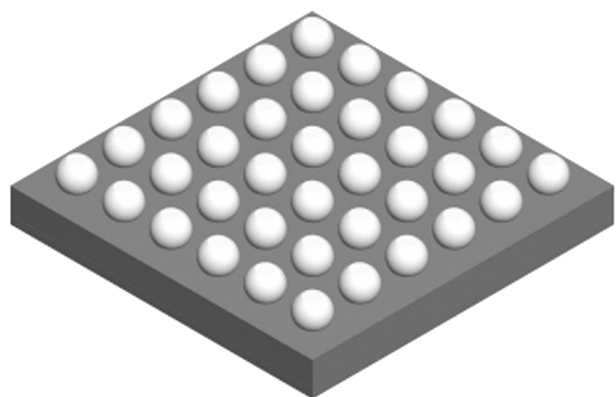

20213033

Bottom View

Pin Descriptions

TABLE 1. Pin Name and Function

Bump Number	Pin Name	Pin Type	Pin Function
A1	NC	No Connect	No Connect (Note 1)
A2	T7	Digital Input	Auxiliary_Control pin (Note 3)
A3	PE	Digital Input	Program Enable EEPROM
A4	MIC2-	Analog Input	microphone 2 input -
A5	MIC2+	Analog Input	microphone 2 input +
A6	Mic Bias	Analog Output	Bias for Microphones
B1	NC	No Connect	No Connect (Note 1)
B2	NC	No Connect	No Connect (Note 1)
B3	T5		Float (Note 2)
B4	GND	Ground	Amplifier ground
B5	T1		Float (Note 2)
B6	MIC1+	Analog Input	Microphone 1 input +
C1	NC	No Connect	No Connect (Note 1)
C2	NC	No Connect	No Connect (Note 1)
C3	T6		Float (Note 2)
C4	T3		Float (Note 2)
C5	GND	Ground	Amplifier ground
C6	MIC1-	Analog Input	Microphone 1 input -
D1	ADR	Digital Input	I ² C Address select
D2	NC	No Connect	No Connect (Note 1)
D3	GND	Ground	Amplifier ground
D4	T4		Float (Note 2)
D5	T2		Float (Note 2)
D6	REF	Analog Reference	Reference Voltage De-coupling
E1	SCL	Digital Input	I ² C Clock
E2	T8	Ground	Connect to GND
E3	NC	No Connect	No Connect (Note 1)
E4	NC	No Connect	No Connect (Note 1)
E5	NC	No Connect	No Connect (Note 1)
E6	NC	No Connect	No Connect (Note 1)
F1	SDA	Digital Input/Output	I ² C Data
F2	I ² CV _{DD}	Supply	I ² C power supply
F3	V _{DD}	Supply	Power Supply
F4	OUT	Analog Output	Optimized Audio Out
F5	LPF	Analog Input	Lowpasss Filter Capacitor
F6	CAL	Digital Input	Calibration Start

Note 1: Connect NC pins to GND for optimum noise performance.

Note 2: Do not ground pins.

Note 3: Force V_{DD} setup for manual calibrations. Force GND setup for calibration circuitry.

Absolute Maximum Ratings (Note 4)

If Military/Aerospace specified devices are required, please contact the National Semiconductor Sales Office/Distributors for availability and specifications.

Supply Voltage	6.0V
Storage Temperature	-85°C to +150°C
ESD Rating (Note 7)	2000V
ESD Rating (Note 8)	200V
Junction Temperature (T_{JMAX})	150°C
Mounting Temperature	235°C
Infrared or Convection (20 sec.)	

Thermal Resistance

$$\theta_{JA} \text{ (microSMD)} \quad 70^\circ\text{C/W}$$

Soldering Information See AN-112 "microSMD Wafers Level Chip Scale Package."

Operating Ratings (Note 5)

Supply Voltage	2.7V to 5.5V
I^2CV_{DD} (Note 13)	1.8V to 5.5V
Temperature Range	-40°C to 85°C

Electrical Characteristics 3.3V and 5.0V (Note 4)

Unless otherwise specified, all limits guaranteed for $T_J = 25^\circ\text{C}$, $V_{DD} = 3.3\text{V}$ and 5.0V , $V_{IN} = 18\text{mV}_{P-P}$, pass through mode (Note 11), preamplifier gain = 20dB, postamplifier gain = -2.5dB, $R_L = 100\text{k}\Omega$, and $C_L = 4.7\text{pF}$.

Symbol	Parameter	Conditions	LMV1088		Units (Limits)
			Typical (Note 9)	Limits (Note 10)	
SNR	Signal-to-Noise Ratio	$f = 1\text{kHz}$, $V_{IN} = 18\text{mV}_{P-P}$, A-Weighted	60		dB
V_{IN}	Max Input Signal	$f = 1\text{kHz}$ and $\text{THD+N} < 1\%$	97		mV_{P-P}
V_{OUT}	AC Output Voltage	$f = 1\text{kHz}$, preamp gain = 36dB $V_{IN} = 30\text{mV}_{P-P}$	500		mV_{RMS}
	DC Output Voltage		800		mV
THD+N	Total Harmonic Distortion + Noise	$f = 1\text{kHz}$, $V_{IN} = 18\text{mV}_{P-P}$	0.1		%
Z_{IN}	Input Impedance		100		$\text{k}\Omega$
Z_{OUT}	Output Impedance		150		Ω
Z_{LOAD}		R_{LOAD}		10	$\text{k}\Omega$ (min)
		C_{LOAD}		10	pF (max)
A_M	Microphone Pre Amplifier Gain Range	$f = 1\text{kHz}$	6 – 36		dB
A_{MR}	Microphone Pre Amplifier Gain Adjustment Resolution	$f = 1\text{kHz}$	2		dB
A_P	Post Amplifier Gain Range	$f = 1\text{kHz}$ Pass Through Mode and Summing Mode	-2.5 – 9.5		dB
		$f = 1\text{kHz}$ Noise Canceling Mode (Note 12)	0 – 12		dB
A_{PR}	Post Amplifier Gain Adjustment Resolution	$f = 1\text{kHz}$	3		dB
A_{CR}	Gain Compensation Range	$f = 300\text{Hz} - f = 3400\text{Hz}$		± 3	dB (max)
A_{MD}	Gain Matching Difference After Calibration	$f = 300\text{Hz}$		0.5	dB (max)
		$f = 1\text{kHz}$		0.5	dB (max)
		$f = 3\text{kHz}$		0.5	dB (max)
T_{CAL}	Calibration Duration			770	ms (max)
PSRR	Power Supply Rejection Ratio	Input Referred, Input AC grounded			
		$f = 217\text{Hz}$ (100mV_{P-P})	85		dB
		$f = 1\text{kHz}$ (100mV_{P-P})	80		dB
CMRR	Common Mode Rejection Ratio	$f = 1\text{kHz}$,	60		dB
V_{BM}	Microphone Bias Supply Voltage	$I_{BIAS} = 1\text{mA}$	2.0		V
ϵ_{VBM}	Microphone Bias Supply Noise	A-Weighted	10		μV_{RMS}
I_{BM}	Total available Microphone Bias Current			1.2	mA (min)
I_{DDQ}	Supply Quiescent Current	$V_{IN} = 0\text{V}$	1	1.5	mA (max)

I_{DDCP}	Supply Current during Calibration and Programming	Calibrating or Programming EEPROM	28	50	mA (max)
I_{DD}	Supply Current	$V_{IN} = 25mV_{P-P}$ both inputs, Noise canceling mode	1	1.5	mA (max)

Digital Interface Characteristics (Notes 4, 13)

Unless otherwise specified, all limits guaranteed for $T_J = 25^\circ\text{C}$, I^2CV_{DD} within the Operating Rating (Note 13)

Symbol	Parameter	Conditions	LMV1088		Units (Limits)
			Typical (Note 9)	Limits (Note 10)	
V_{IH}	Logic High Input Level	SCL, SDA, ADR, CAL, PE pins		$0.6 \times I^2CV_{DD}$	V (min)
V_{IL}	Logic Low Input Level	SCL, SDA, ADR, CAL, PE pins		$0.4 \times I^2CV_{DD}$	V (max)
t_{SCAL}	CAL Setup Time		2		ms
t_{hCAL}	CAL Hold time until calibration is finished			770	ms (min)
t_{SPEC}	PE Setup Time		2		ms
t_{hPEC}	PE Hold until calibration is finished			770	ms (min)

Note 4: "Absolute Maximum Ratings" indicate limits beyond which damage to the device may occur, including inoperability and degradation of device reliability and/or performance. Functional operation of the device and/or non-degradation at the Absolute Maximum Ratings or other conditions beyond those indicated in the Recommended Operating Conditions is not implied. The Recommended Operating Conditions indicate conditions at which the device is functional and the device should not be operated beyond such conditions. All voltages are measured with respect to the ground pin, unless otherwise specified.

Note 5: The Electrical Characteristics tables list guaranteed specifications under the listed Recommended Operating Conditions except as otherwise modified or specified by the Electrical Characteristics Conditions and/or Notes. Typical specifications are estimations only and are not guaranteed.

Note 6: The maximum power dissipation must be de-rated at elevated temperatures and is dictated by T_{JMAX} , θ_{JC} , and the ambient temperature T_A . The maximum allowable power dissipation is $P_{DMAX} = (T_{JMAX} - T_A) / \theta_{JA}$ or the number given in the Absolute Maximum Ratings, whichever is lower. For the LMV1088, $T_{JMAX} = 150^\circ\text{C}$ and the typical θ_{JA} for this microSMD package is 70°C/W and for the LLP package θ_{JA} is 64°C/W . Refer to the Thermal Considerations section for more information.

Note 7: Human body model, applicable std. JESD22-A114C.

Note 8: Machine model, applicable std. JESD22-A115-A.

Note 9: Typical values represent most likely parametric norms at $T_A = +25^\circ\text{C}$, and at the Recommended Operation Conditions at the time of product characterization and are not guaranteed.

Note 10: Datasheet min/max specification limits are guaranteed by test, or statistical analysis.

Note 11: In Pass Through mode, only one microphone input is active. See also *I²C Compatible Interface* for more information how to configure the LMV1088.

Note 12: In Noise Canceling Mode there is 2.5dB additional gain before calibration when compared to the other operating modes to compensate for the gain reduction that is caused by the noise canceling effect.

Note 13: The voltage at I^2CV_{DD} must not exceed the voltage on V_{DD} .

Typical Performance Characteristics Unless otherwise specified, $T_J = 25^\circ\text{C}$, $V_{DD} = 3.3\text{V}$, $V_{IN} = 18\text{mV}_{P-P}$, $I_{MICBIAS}$ pass through mode (Note 11), preamplifier gain = 20dB, postamplifier gain = -2.5dB, $R_L = 100\text{k}\Omega$, and $C_L = 4.7\text{pF}$.

Supply Current vs. Supply Voltage

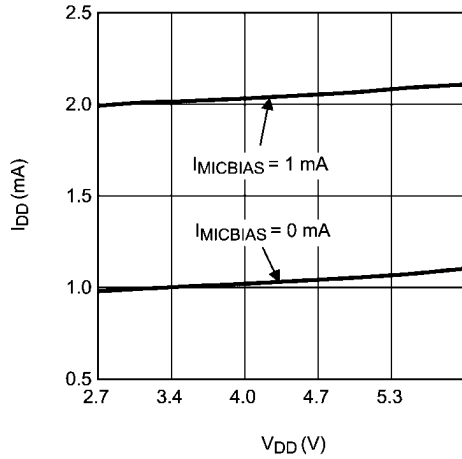

20213021

THD+N vs Frequency, pass through mode Mic1
 $V_{IN} = 36\text{mV}_{P-P}$

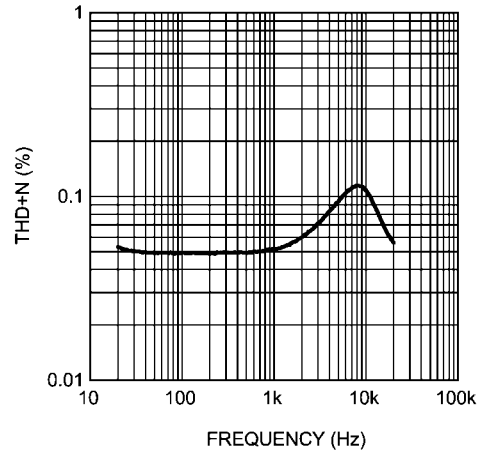

20213003

THD+N vs Frequency, pass through mode Mic2
 $V_{IN} = 36\text{mV}_{P-P}$

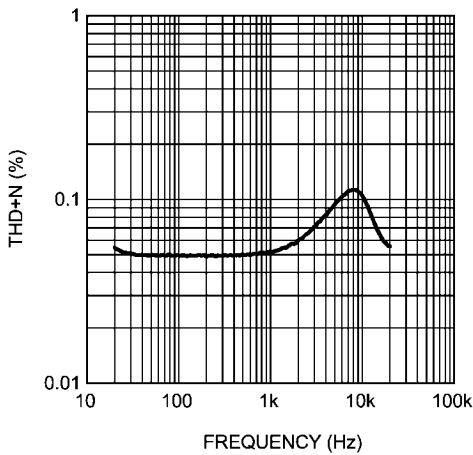

20213004

THD+N vs Frequency, Noise canceling mode
signal at Mic1, Mic2 AC shorted, $V_{IN} = 36\text{mV}_{P-P}$

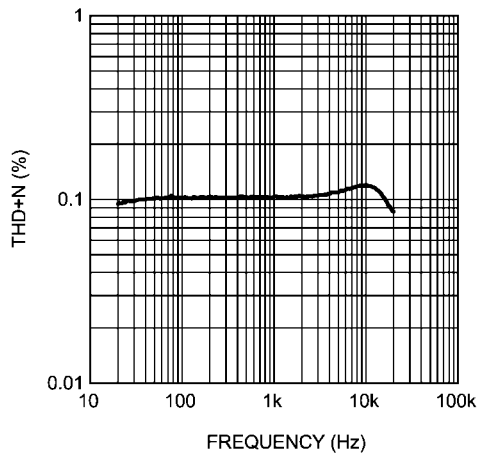

20213005

THD+N vs Frequency, Noise canceling mode
Mic1 AC shorted, signal at Mic2, $V_{IN} = 36\text{mV}_{P-P}$

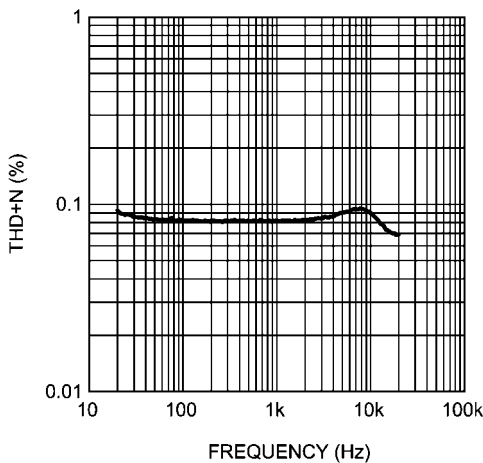

20213006

THD+N vs V_{IN} , pass through mode Mic1

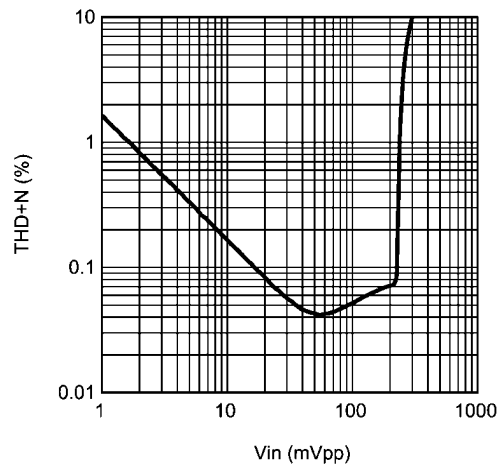

20213016

THD+N vs V_{IN} , pass through mode Mic2

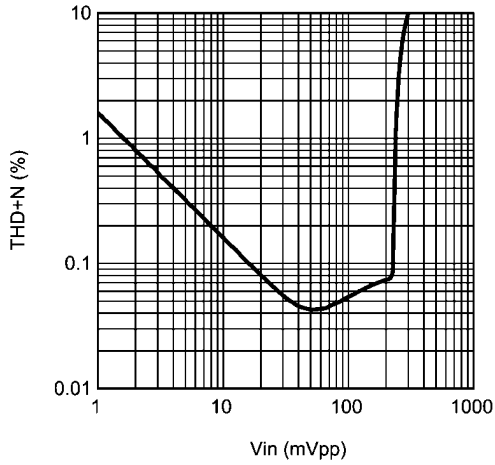

20213015

THD+N vs V_{IN} , Noise canceling mode signal at Mic1, Mic2 AC shorted

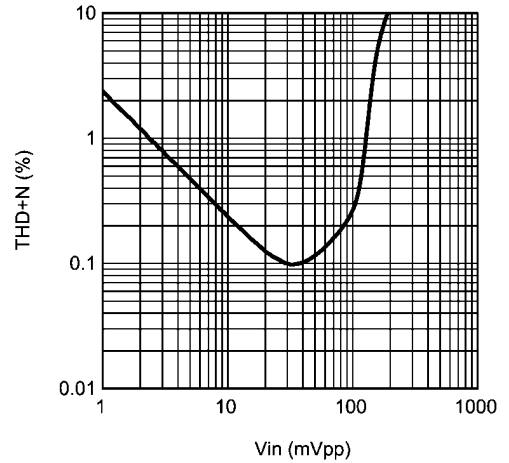

20213014

THD+N vs V_{IN} , Noise canceling mode Mic1 AC shorted, signal at Mic2

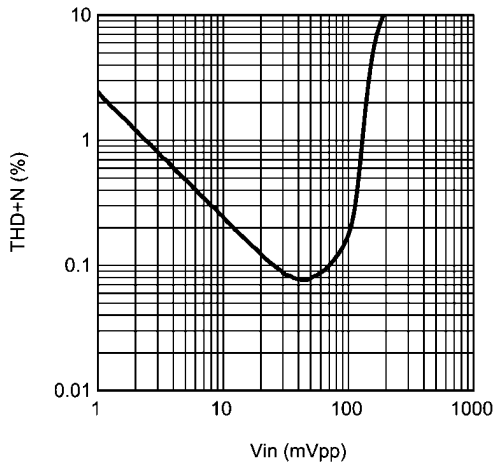

20213017

PSRR vs Frequency, pass through mode Mic1 Mic1+ Mic2 AC shorted

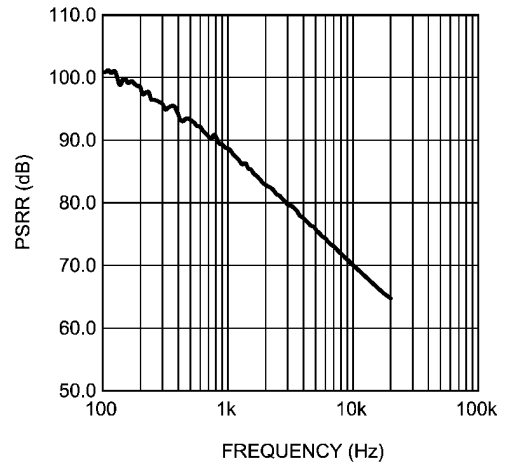

20213018

PSRR vs Frequency, pass through mode Mic2 Mic1+ Mic2 AC shorted

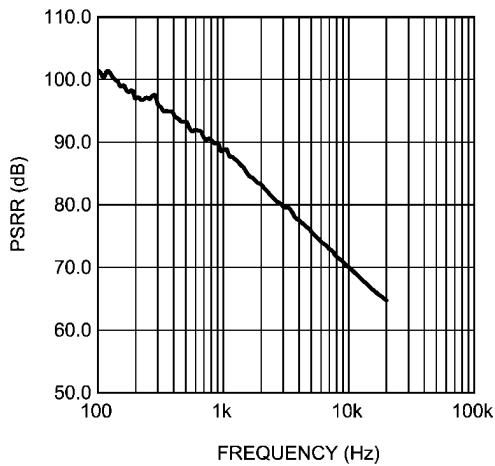

20213019

PSRR vs Frequency, Noise canceling mode Mic1+ Mic2 AC shorted

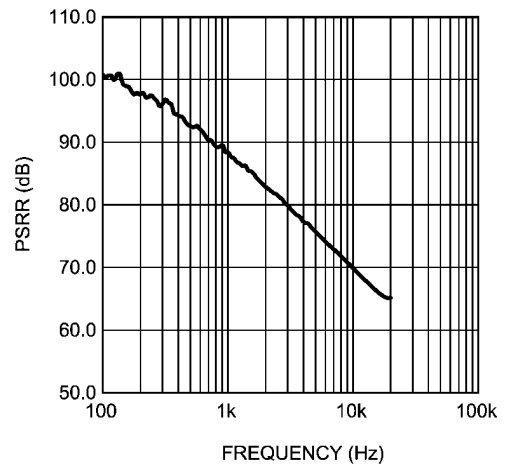

20213020

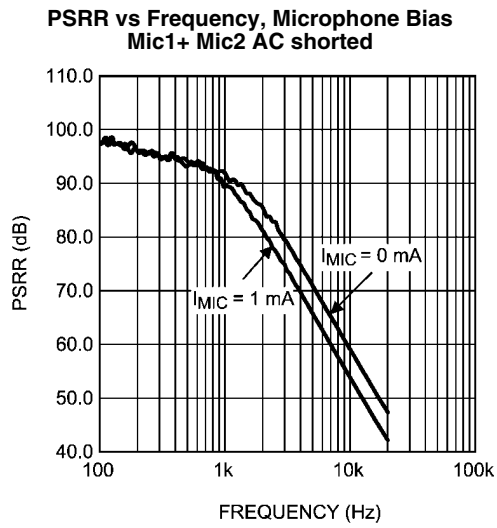

20213022

Application Data

Gain Balance and Gain Budget

In systems where input signals have a high dynamic range, critical noise levels and where the dynamic range of the output voltage is also limited, careful gain balancing can be essential

for the best performance. Having not enough gain in the Pre Amplifier can result in higher noise levels while too much gain in the Pre Amplifier will result in clipping and saturation in the noise cancelling processor and output stages.

The gain ranges and maximum signal levels for the different functional blocks is shown in Figure 2. Two examples are given as a guideline how to select proper gain settings.

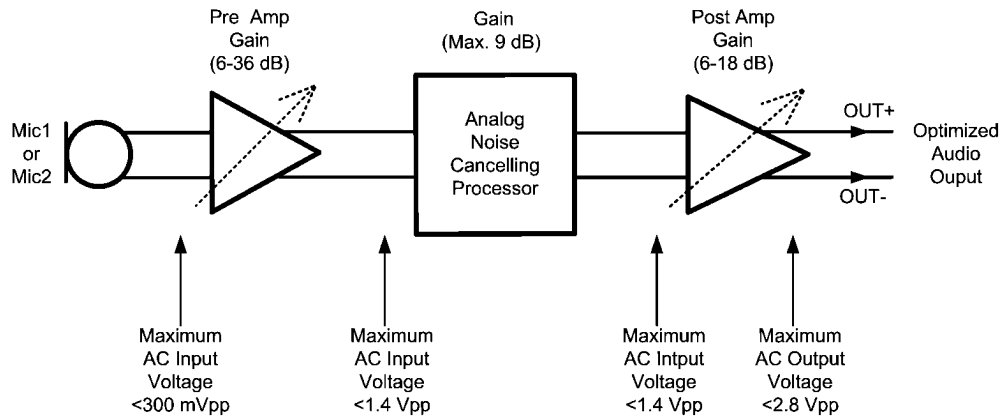

20213037

FIGURE 2. Maximum Signal Levels

EXAMPLE 1

An application using microphones with 50mV_{pp} maximum output voltage, and a baseband chip after the LMV1088 with 1.5V_{pp} maximum input voltage.

For optimum noise performance we would like to have the maximum gain at the input stage.

So using Pre Amp gain = 14dB and Post Amp gain = 6dB is the optimum for this application.

- $50\text{mV}_{pp} + 36\text{ dB} = 3.1\text{V}_{pp}$.
- This is higher than the maximum 1.4V_{pp} allowed for the Noise Cancelling Processor (NCP). This means a gain lower than 28.9dB should be selected.
- Select the nearest lower gain from the gain setting table to be 28dB. This will prevent the NCP from being overloaded by the microphone. With this setting, the resulting output level of the Pre Amplifier will be 1.26V_{pp} .
- The NCP can have a maximum processing gain of 9dB (depending on the calibration result) which will result in 3.5V_{pp} at the output of the LMV1088. This level is higher than maximum level that is allowed at the input of the Post Amp of the LMV1088. Therefore the Pre Amp gain has to be reduced, to 1.4V_{pp} minus 9dB = 0.5V_{pp} . This limits the Pre Amp gain to a maximum of 20dB.
- The baseband chip limits the maximum output voltage to 1.5V_{pp} with the minimum of 6dB Post Amp gain, this results in having a lower level at the input of the Post Amp of 0.75V_{pp} . Now calculating this for a maximum NCP gain of 9dB the output of the Pre Amp must be $<266\text{mV}_{pp}$.
- Calculating the new gain for the Pre Amp will result in $<1.4\text{ dB}$ gain.
- The nearest lower gain will be 14dB.

So using Pre Amp gain = 14dB and Post Amp gain = 6dB is the optimum for this application.

EXAMPLE 2

An application using microphones with 10mV_{pp} maximum output voltage, and a baseband chip after the LMV1088 with 3.3V_{pp} maximum input voltage.

For optimum noise performance we would like to have the maximum gain at the input stage.

- $10\text{mV}_{pp} + 36\text{ dB} = 631\text{mV}_{pp}$.
- This is lower than the maximum 1.4V_{pp} so this is OK.
- The NCP can have a maximum processing gain of 9dB (depending on the calibration result) which will result in 3.5V_{pp} at the output of the LMV1088. This level is higher than maximum level that is allowed at the input of the Post Amp of the LMV1088. Therefore the Pre Amp gain has to be reduced, to 1.4V_{pp} minus 9dB = 0.5V_{pp} . This limits the Pre Amp gain to a maximum of 34dB.
- With a Post Amp gain setting of 6dB the output of the Post Amp will be 2.8V_{pp} which is OK for the baseband.
- The nearest lower Post Amp gain will be 6dB.

So using Pre Amp gain = 14dB and Post Amp gain = 6dB is the optimum for this application.

I²C Compatible Interface

I²C SIGNALS

The LMV1088 pin Serial Clock (SCL) is used for the I²C clock SCL and the pin Serial Data (SDA) is used for the I²C data signal SDA. Both of these signals need a pull-up resistor according to I²C specification. The LMV1088 can be controlled through two slave addresses. The two I²C slave address for LMV1088 are given in Table 2.

TABLE 2. Chip Address

	D7	D6	D5	D4	D3	D2	D1	D0
1 st Chip Address I ² C Address='0'	1	1	0	0	1	1	0	\bar{W}/R
2 nd Chip Address I ² C Address='1'	1	1	0	0	1	1	1	\bar{W}/R

I²C DATA VALIDITY

The data on SDA line must be stable during the HIGH period of the clock signal (SCL). In other words, state of the data line can only be changed when SCL is LOW.

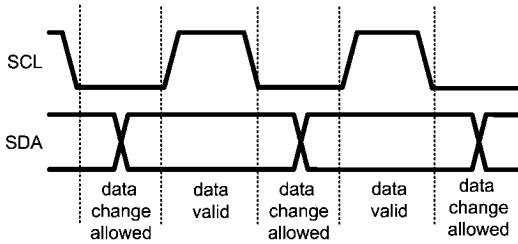

I²C Signals: Data Validity

202130q1

I²C START AND STOP CONDITIONS

START and STOP bits classify the beginning and the end of the I²C data transmission session. START condition is defined as SDA signal transitioning from HIGH to LOW while SCL line is HIGH. STOP condition is defined as the SDA transitioning from LOW to HIGH while SCL is HIGH. The I²C master always generates START and STOP bits. The I²C bus is considered to be busy after START condition and free after STOP condition. During data transmission, I²C master can generate repeated START conditions. First START and repeated START conditions are equivalent, function-wise. (Note 14)

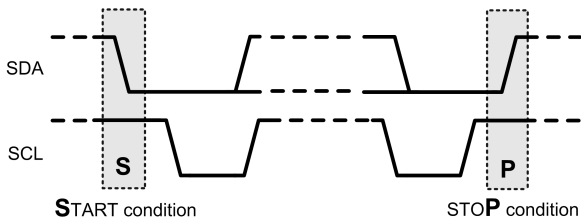

I²C Start Stop Conditions

202130q2

Note 14: The master should issue STOP after no acknowledgement.

TRANSFERRING DATA

Every byte put on the SDA line must be eight bits long, with the most significant bit (MSB) being transferred first. Each byte of data has to be followed by an acknowledge bit. The acknowledge related clock pulse is generated by the master. The transmitter releases the SDA line (HIGH) during the acknowledge clock pulse. The receiver must pull down the SDA line during the 9th clock pulse, signifying an acknowledge. A receiver which has been addressed must generate an acknowledge after each byte has been received.

After the START condition, the I²C master sends a chip address. This address is seven bits long followed by an eighth bit which is a data direction bit (R/W). The LMV1088 address is **11001100₂** or **11001110₂**. For the eighth bit, a "0" indicates a WRITE and a "1" indicates a READ. The second byte selects the register to which the data will be written. The third byte contains data to write to the selected register.

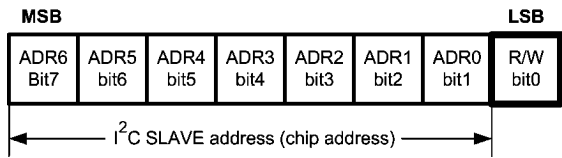

I²C Chip Address

202130q3

Register changes take effect at the SCL rising edge during the last acknowledge (ACK) from slave.

In Figure 3 there is a write example shown, for a device at a randomly chosen address '00110100₂'.

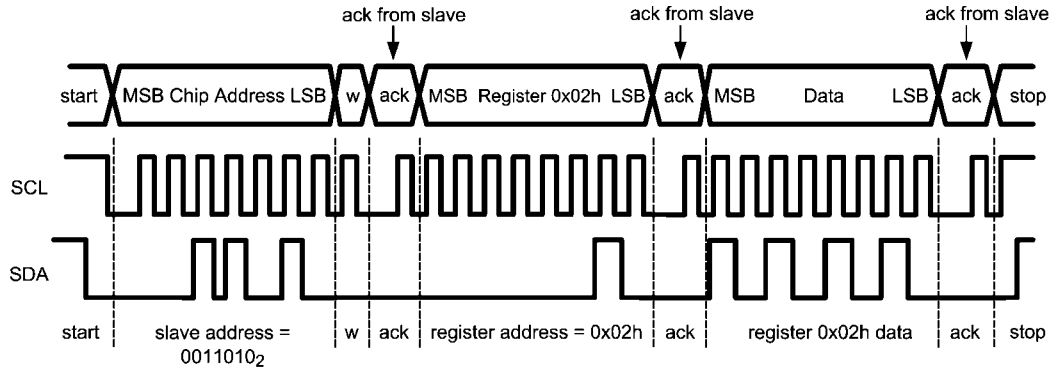

202130q5

w = write (SDA = "0")
 r = read (SDA = "1")
 ack = acknowledge (SDA pulled down by slave)
 rs = repeated start

FIGURE 3. Example I²C Write Cycle

When a READ function is to be accomplished, a WRITE function must precede the READ function.

Figure 3, shows a read example for a device at a random chosen address '00110101₂'.

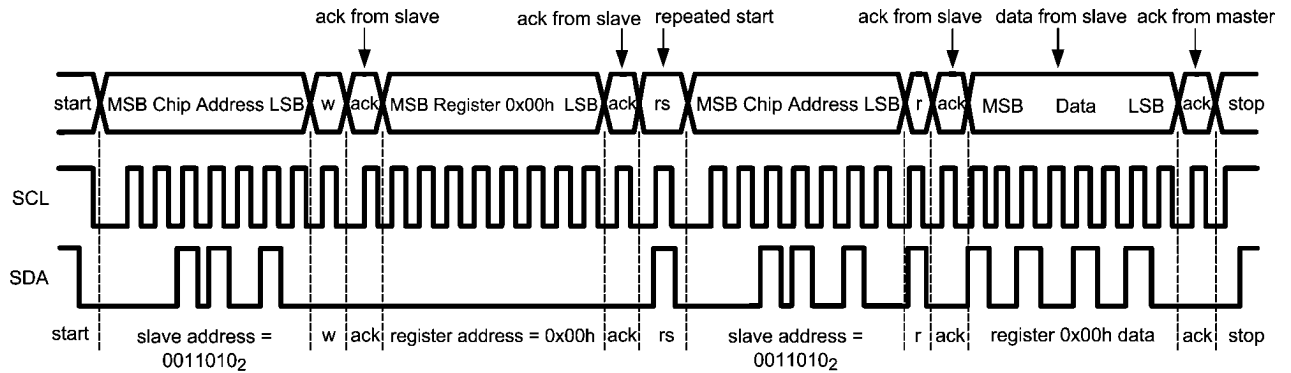

202130q6

FIGURE 4. Example I²C Read Cycle

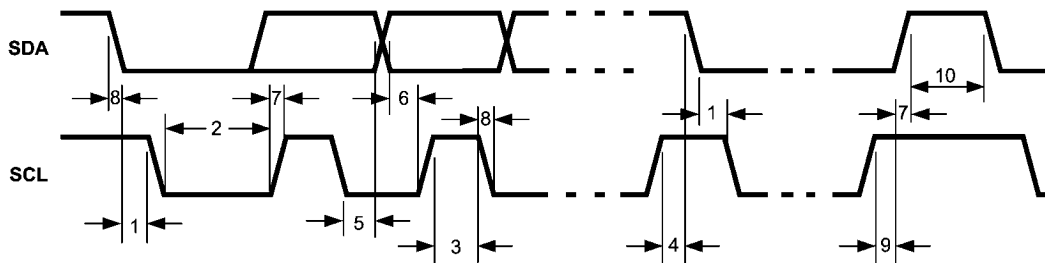

202130q9

FIGURE 5. I²C Timing Diagram

TABLE 3. I²C Timing Parameters

Symbol	Parameter	Limit		Units
		Min	Max	
1	Hold Time (repeated) START Condition	0.6		μs
2	Clock Low Time	1.3		μs
3	Clock High Time	600		ns
4	Setup Time for a Repeated START Condition	600		ns
5	Data Hold Time (Output direction, delay generated by LMV1088)	300	900	ns
5	Data Hold Time (Input direction, delay generated by the Master)	0	900	ns
6	Data Setup Time	100		ns
7	Rise Time of SDA and SCL	20	300	ns
8	Fall Time of SDA and SCL	15	300	ns
9	Set-up Time for STOP condition	600		ns
10	Bus Free Time between a STOP and a START Condition	1.3		μs
C _b	Capacitive Load for Each Bus Line	10	200	pF

NOTE: Data guaranteed by design

TABLE 4. I²C Register Description

Address	Reg.	Bits	Description	Default		
0x01h	A	[3:0]	Microphone preamplifier gain from 6dB up to 36dB in 2dB steps.	0111		
			0000		6dB	
			0001		8dB	
			0010		10dB	
			0011		12dB	
			0100		14dB	
			0101		16dB	
			0110		18dB	
			0111		20dB	
			1000		22dB	
			1001		24dB	
			1010		26dB	
			1011		28dB	
			1100		30dB	
			1101		32dB	
		1110	34dB			
1111	36dB					
	[5:4]	A4 = Mute mic1 and A5 = mute mic2. (0 = microphone on; 1 = microphone mute)				
	[7:6]	Mic enable bits, A6 = enable Mic 1, A7 = enable Mic 2 (1 = enable Mic; 0 = disable Mic)				
0x02h	B	[2:0]	Gain setting for the post amplifier from (3dB steps) (Note 12).	0+00		
					Pass Through mode	Noise Canceling mode
			000		-2.5dB	0db
			001		0.5dB	3dB
			010		3.5dB	6dB
			011		6.5dB	9dB
			100		9.5dB	12dB
			101		9.5dB	12dB
		110	9.5dB	12dB		
		111	9.5dB	12dB		
			[4:3]	Mic select bits	Noise canceling mode	00
			00			
	01		Only Mic 1 on			
	10		Only Mic 2 on			
		11		Mic 1 + Mic 2		
	[7:5]	Not Used		000		
0x0Ch	L	[7:0]	reads the output of the EEPROM	read only		
0x0Dh	M	[7:0]	reads the output of the EEPROM	read only		
0x0Eh	N	[6:0]	reads the output of the EEPROM	read only		
		[7]	Reads the "ready" signal. This give the status of the program cycle. 1 = ready ; 0 = program cycle in progress	read only		

Address	Reg.	Bits	Description	Default	
0x0Fh	O	[7:4]	Control the gain compensation between the two mics at 300Hz (Note 1)		0000
			0000 (0)	0.0dB	
			0001 (1)	0.5dB	
			0010 (2)	1.0dB	
			0011 (3)	1.5dB	
			0100 (4)	2.0dB	
			0101 (5)	2.5dB	
			0110 (6)	3.0dB	
			0111 (7)	Not used	
			1000 (8)	Not used	
			1001 (9)	-0.5dB	
			1010 (A)	-1.0dB	
			1011 (B)	-1.5dB	
			1100 (C)	-2.0dB	
			1110 (D)	-2.5dB	
			1110 (E)	-3.0dB	
		1111 (F)	Not Used		
		[3:0]	Control the gain compensation between the two mics at 3kHz (Note 1)		0000
			0000 (0)	0.0dB	
			0001 (1)	0.5dB	
			0010 (2)	0.0dB	
			0011 (3)	1.5dB	
			0100 (4)	2.0dB	
			0101 (5)	2.5dB	
			0110 (6)	3.0dB	
			0111 (7)	Not used	
			1000 (8)	Not used	
			1001 (9)	-0.5dB	
1010 (A)	-1.0dB				
1011 (B)	-1.5dB				
1100 (C)	-2.0dB				
1101 (D)	-2.5dB				
1110 (E)	-3.0dB				
1111 (F)	Not used				

Address	Reg.	Bits	Description	Default	
0x10h	P	[7:4]	Control compensation gain for Mic2 channel at ALL frequencies (Note 1)		0000
			0000 (0)	-3.0dB	
			0001 (1)	-3.0dB	
			0010 (2)	-2.5dB	
			0011 (3)	-2.0dB	
			0100 (4)	-1.5dB	
			0101 (5)	-1.0dB	
			0110 (6)	-0.5dB	
			0111 (7)	0.0dB	
			1000 (8)	0.0dB	
			1001 (9)	0.5dB	
			1010 (A)	1.0dB	
			1011 (B)	1.5dB	
			1100 (C)	2.0dB	
		1101 (D)	2.5dB		
		1110 (E)	3.0dB		
		1111 (F)	3.0dB		
		[3:0]	Control compensation gain for Mic1 channel at ALL frequencies (Note 1)		0000
			0000 (0)	-3.0dB	
			0001 (1)	-3.0dB	
			0010 (2)	-2.5dB	
			0011 (3)	-2.0dB	
			0100 (4)	-1.5dB	
			0101 (5)	-1.0dB	
			0110 (6)	-0.5dB	
			0111 (7)	0.0dB	
1000 (8)	0.0dB				
1001 (9)	0.5dB				
1010 (A)	1.0dB				
1011 (B)	1.5dB				
1100 (C)	2.0dB				
1101 (D)	2.5dB				
1110 (E)	3.0dB				
1111 (F)	3.0dB				
0x11h	Q	[6:0]	Values are clocked into EEPROM registers once "newdata" pulse is generated		
		[7]	StoreBar signal storeBar = 0 enables EEPROM programming storeBar = 1 data clock into EEPROM registers	1	
0x12h	R	[0]	Start Calibration via I2C '0' to '1' = start calibration (keep '1' during calibration)		0
		[7]	Internal test		000000 0

() represents binary value in hexadecimal format

Automatic Calibration

The full automatic calibration should only be required once, when the product containing the LMV1088 has completed manufacture, and prior to application packaging. The product containing the LMV1088 will be calibrated to the microphones, the microphone spacings, and the acoustical properties of the final manufactured product containing the LMV1088.

The compensation or calibration technology is achieved via memory stored coefficients when the FFNS circuitry activates the calibration sequence. The purpose of the calibration sequence is to choose the optimized coefficients for the FFNS circuitry for the given microphones, spacing, and acoustical environment of the product containing the LMV1088.

A basic calibration can be performed with a single 1kHz tone, however to take full advantage of this calibration feature a three tone calibration (See the section *PERFORMING A THREE TONE CALIBRATION*) is preferred.

The automatic calibration process can be initiated from either a digital interface CALIBRATE pin (CAL) or via the I²C interface.

The logic level at the PROGRAM ENABLE (PE) pin determines if the result of the calibration is volatile or permanent.

To make the result of the calibration permanent (stored in the EEPROM) the PROGRAM ENABLE (PE) pin must be high during the automatic calibration process.

AUTOMATIC CALIBRATION VIA CAL PIN

To initiate the automatic calibration via the CAL pin, the following procedure is required:

- From the initial condition where both PE and CAL are at 'low' level
- bring PE to a 'high' level (enable EEPROM write)
- bring CAL to a 'high' level to start Calibration
- Apply Audio stimulus (single tone 1kHz or three tone sequence as described in *PERFORMING A THREE TONE CALIBRATION*)
- Hold CAL 'high' for at least 770ms
- Remove Audio stimulus
- bring CAL to a 'low' level to stop Calibration
- bring PE to a 'low' level (disable EEPROM write)

A tone may be applied prior to the rising of CAL and PE. Signals applied to the microphone inputs before rising of CAL and PE are ignored by the calibration system.

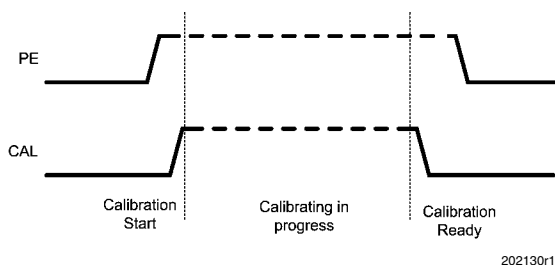

FIGURE 6. Automatic Calibration via CAL pin

Note: When the I²C is operated, make sure that register 'R' (address 0x12) bit 0 is '0' before operating the CAL pin (default value for this bit). When this bit is set '1' the calibration engine of the LMV1088 is started and will remain active with a higher supply current than normal operation. The state of the calibration remains active until this bit is reset, '0'. With the bit set the 'low' to 'high' transfer of the CAL pin will be ignored.

AUTOMATIC CALIBRATION VIA I²C COMMAND

To initiate the automatic calibration via the I² interface, the following procedure is required:

- From the initial condition where PE is 'low' level
- Bring PE to a 'high' level (enable EEPROM write)
- Write '1' into I²C register 'R' (address 0x12) bit 0 to start calibration

- Apply Audio stimulus (single tone 1kHz or three tone sequence as described in *PERFORMING A THREE TONE CALIBRATION*)
- Wait at least 770ms
- Remove Audio stimulus
- Write '0' into I²C to finish calibration
- Bring PE to a 'low' level (disable EEPROM write)

A tone may be applied prior to the rising of CAL and PE. Signals applied to the microphone inputs before rising of CAL and PE are ignored by the calibration system.

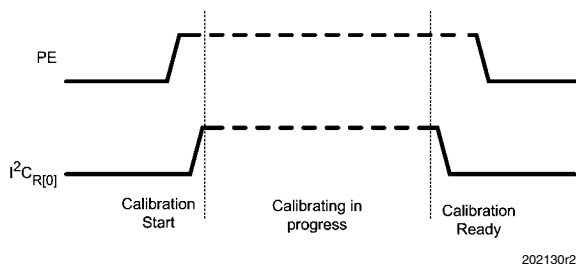

FIGURE 7. Automatic Calibration via I²C COMMAND

PERFORMING A THREE TONE CALIBRATION

In a system with two microphones in an enclosure there will always be a difference in the transfer function in both gain and frequency response. The LMV1088 has the capability to perform an automatic calibration function to minimize these differences. To perform this calibration, a test sequence of three tones is required right after the PE and CAL inputs are brought to a logic high level. At the end of this sequence the calibration data is automatically stored in the internal EEPROM.

The three tones have to be applied as follows:

- A first tone with a frequency of 1kHz

- A second tone with a frequency of 300Hz
- A third tone with a frequency of 3kHz

A tone may be applied prior to the rising of CAL and PE. Signals applied to the microphone inputs before rising of CAL and PE are ignored by the calibration system. .

Between each tone pair there is a small time, indicated by a cross, to change the frequency. During that time the input tone is ignored by the calibration system.

The total calibration sequence requires less then 770ms.

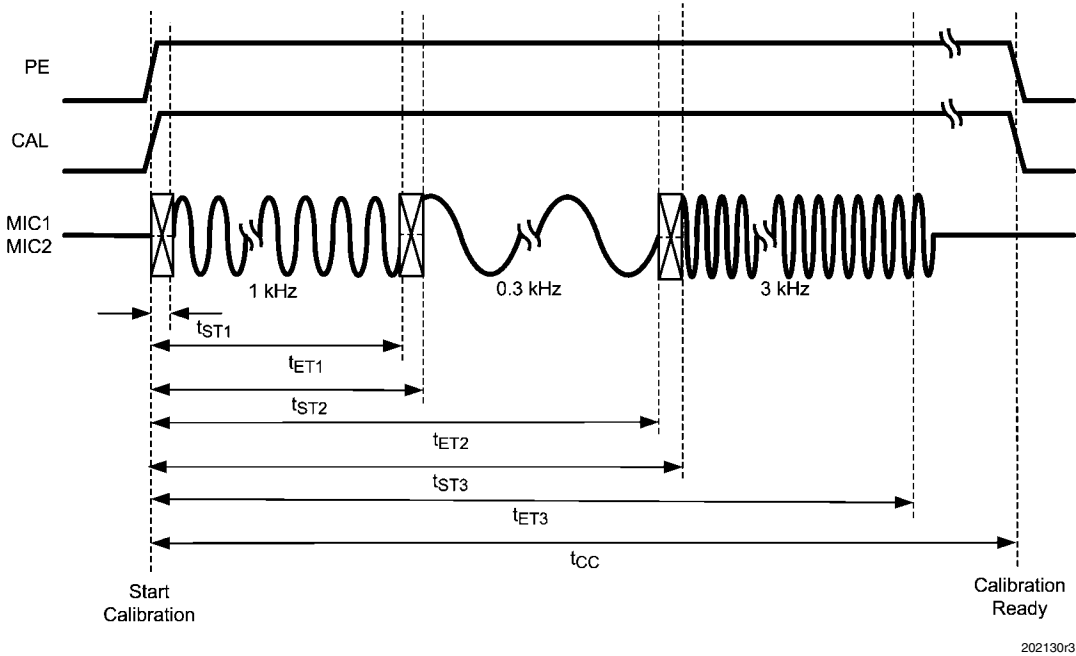

FIGURE 8. Three Tone Calibration Timing

TABLE 5. Automatic Calibration Timing Parameters

Symbol	Parameter	Limits		Unitis
		Min	Max	
t_{ST1}	Calibration Start Tone 1		10	ms
t_{ET1}	Calibration End Tone 1	200		ms
t_{ST2}	Calibration Start Tone 2		215	ms
t_{ET2}	Calibration End Tone 2	400		ms
t_{ST3}	Calibration Start Tone 3		415	ms
t_{ET3}	Calibration End Tone 3	600		ms
t_{CC}	Calibration Complete	770		ms

NOTE: Data guaranteed by design

THREE TONE CALIBRATION SETUP

A calibration test setup consist of a test room (acoustical box) with a loudspeaker (acoustical source) driven with the test tone sequence from *Figure 8*. The test setup is shown in *Figure 9*. The distance between the source and microphone 1 and microphone 2 must be equal and the sound must travel without any obstacle from source to both microphones.

The sound will travel with the limited speed of 300m/s from the loudspeaker source to the microphones. When creating the calibration signals this time should not be ignored, 30cm distance will cause 1ms delay.

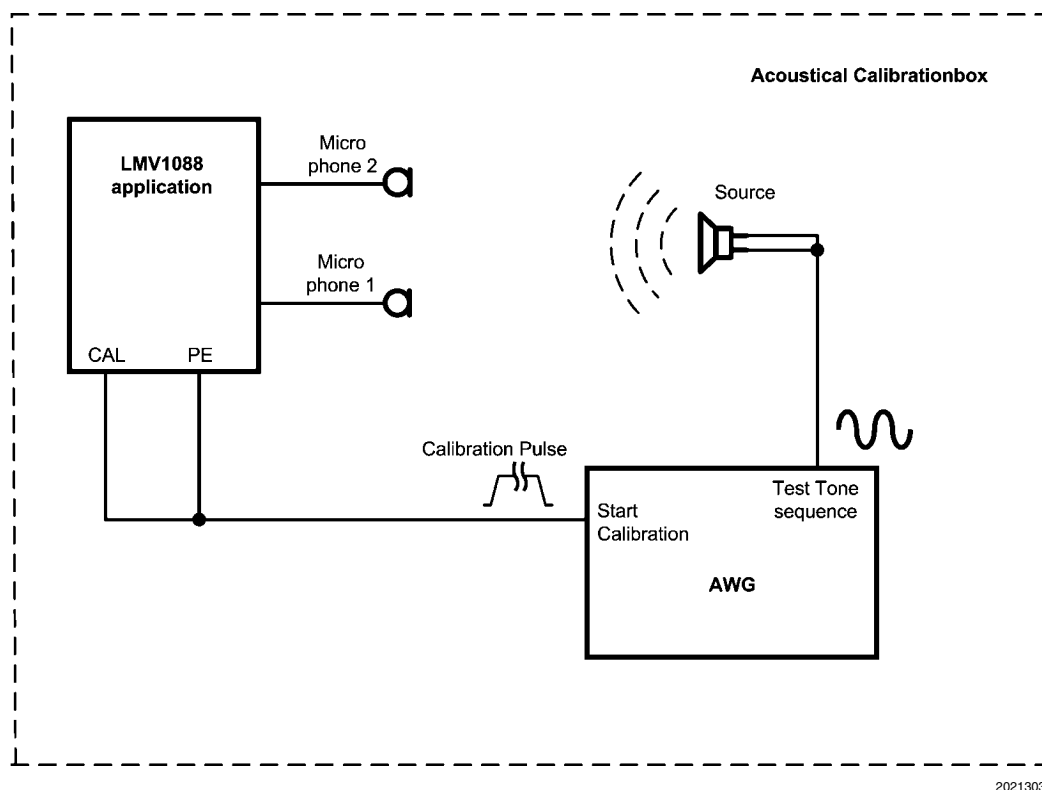

20213035

FIGURE 9. Three Tone Calibration Test setup

SUPPLY CURRENT DURING CALIBRATION

The Calibration function performs two main tasks in a sequence. First the AC characteristics of the microphones are matched. Then in the second stage, if the PE pin is high, the on-chip EEPROM is programmed.

During the first stage of this sequence the supply current on the LMV1088 will increase to about 2.5 mA. During the writing of the EEPROM the supply current will rise for about 215ms to about 30 mA. This increased current is used for the on chip charge pump which generates the high voltages that are required for programming the EEPROM.

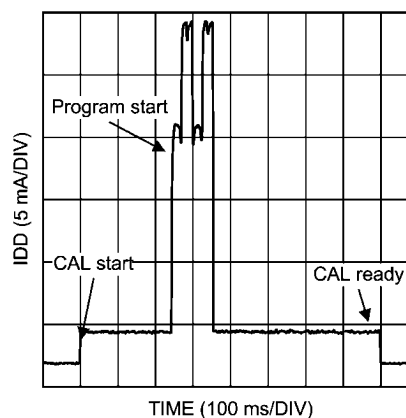

20213036

FIGURE 10. Supply current during calibration and programming

Manual Calibration

You can manually program the gain of the two mic inputs on the LMV1088 using the I²C interface. Table 5 shows the control bits for I²C Register O and P with the corresponding gains. This can be easily done by doing the following:

1) READ contents of the I²C register N immediately after powering up.

2) Set PE pin and T7 pin to Vdd.

3) WRITE to I²C register O and P to choose the calibration settings.

Bits O<7:4> control the two mics at 300 Hz and bits O<3:0> control the two mics at 3kHz.

Bits P<7:4> control the Mic2 gain and bits P<3:0> control the Mic1 gain

4) WRITE a '0' to I²C register Q<7> bit (storeBar) and the bits from I²C register N<6:0> to I²C register Q<6:0>

5) When I²C register N<7> (ready) goes high, then the EEPROM programming is complete. Now PE pin and T7 pin should be set to GND and I²C register Q<7> (storeBar) should be returned to '1'.

Low-Pass Filter At The Output

At the output of the LMV1088 there is a provision to create a 1st order low-pass filter (only enabled in 'Noise Cancelling' mode). This low-pass filter can be used to compensate for the change in frequency response that results from the noise cancellation process.. The change in frequency response resembles a first-order high-pass filter, and for many of the applications it can be approximately compensated by a first-order low-pass filter with cutoff frequency between 1.5kHz and 2.5kHz.

The transfer function of the low pass filter is derived as:

$$H(s) = \text{Post Amplifier} / (SRfCf + 1)$$

This low-pass filter is created by connecting a capacitor between the LPF pin and the OUT pin of the LMV1088. The value of this capacitor also depends on the selected output gain. For different gains the feedback resistance in the Low-pass Filter network changes as shown in *Table 6*.

TABLE 6. Low-pass Filter internal impedance

Post Amplifier Gain Setting (dB) (Note 15)	Feedback resistance R _{ff} (kΩ)
0	20
3	29
6	40
9	57
12	80

This will result in the following values for a cutoff frequency of 2000 Hz:

TABLE 7. Low—pass Filter Capacitor for 2kHz

Post Amplifier Gain Setting (dB) (Note 15)	R _{ff} (kΩ)	C _f (nF)
0	20	3.9
3	29	2.7
6	40	2.0
9	57	1.3
12	80	1.0

Note 15: Noise Cancelling Mode

Measurement Setup

Because of the nature of the calibration system it is not possible to predict the absolute gain in the two microphone channels of the Far Field Noise Cancelling System. This is because, after the calibration function has been operated, the noise cancelling circuit will compensate for the difference in gain between the microphones. In Noise Cancelling mode, this can result in a final gain offset of max 3dB between the gain set in the registers (RA[3:0] and RB[2:0]) and the actual measured gain between input and output of the LMV1088. After performing a calibration the frequency characteristic of the microphone channels will be matched for the two microphones. As a result of this matching there can be a slight slope in the frequency characteristic in one or both amplifiers.

A-WEIGHTED FILTER

The human ear is sensitive for acoustic signals within a frequency range from about 20Hz to 20kHz. Within this range the sensitivity of the human ear is not equal for each frequency. To approach the hearing response, weighting filters are introduced. One of those filters is the A-weighted filter.

The A-weighted filter is used in signal to noise measurements and THD+N measurements, where the wanted audio signal is compared to device noise and distortion.

The use of this filter improves the correlation of the measured values to the way these ratios are perceived by the human ear.

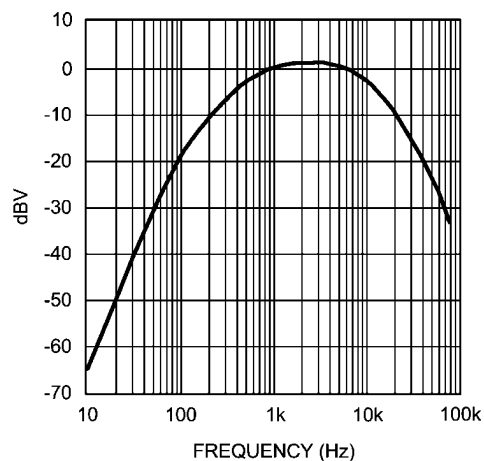

20213010

FIGURE 11. A-Weighted Filter

MEASURING NOISE AND SNR

The overall noise of the LMV1088 is measured within the frequency band from 10Hz to 22kHz using an A-weighted filter.

The Mic+ and Mic- inputs of the LMV1088 are shorted for AC signals via a short between the input capacitors, see *Figure 12*.

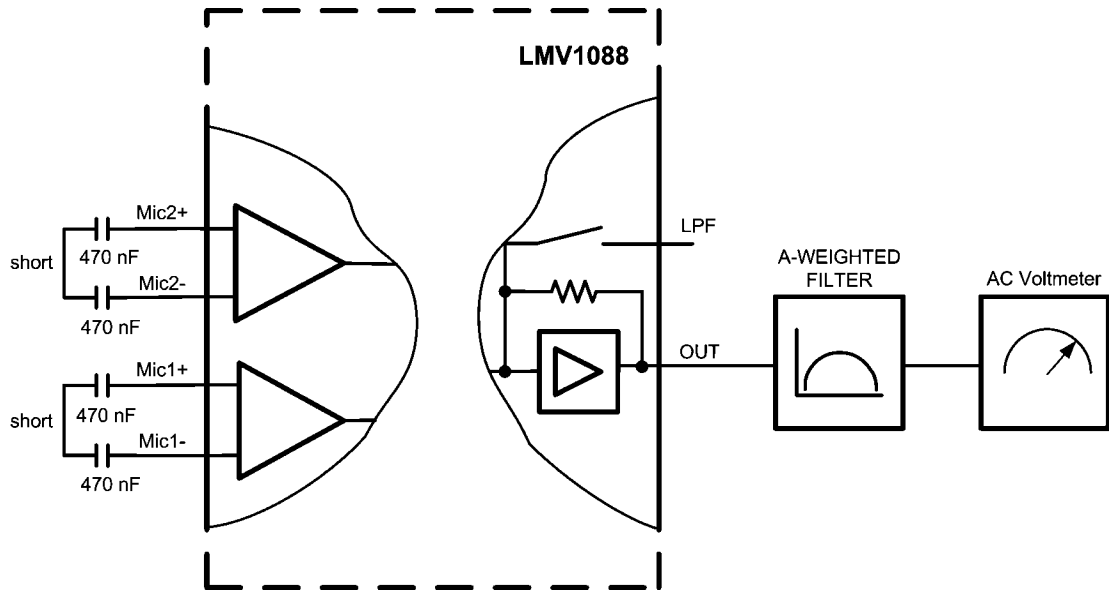

20213011

FIGURE 12. Noise Measurement Setup

For the signal to noise ratio (SNR) the signal level at the output is measured with a 1kHz input signal of 18mV_{pp} using an A-weighted filter. This voltage represents the output voltage of a typical electret condenser microphone at sound pressure level of 94dB SPL, which is the standard level for these measurements. The LMV1088 is programmed for 17.5dB of total

gain (20dB pre-amplifier and -2.5dB post-amplifier) with only Mic1 or Mic2 on. (See also *I²C Compatible Interface*)

The input signal is applied differential between the corresponding Mic+ and Mic-. Because the part is in Pass Through mode the Low-pass Filter at the output of the LMV1088 is disabled.

Revision History

Rev	Date	Description
1.0	09/26/07	Initial release.
1.01	12/10/07	Few text edits (changed TL to RL).
1.02	03/07/08	Text edits.
1.03	03/10/08	Replaced Typical Appl. ckt diagrams and some text edits.
1.04	03/12/08	Deleted 5.0V EC table.
1.05	03/14/08	Replaced Tables 4 and 5. Also edited the Application diagram on page 1.
1.06	03/25/08	Text edits and replaced the Typical Application circuit diagram.
1.07	03/28/08	Text edits.
1.08	04/04/08	Text edits.
1.09	04/17/08	Text edits.
1.10	05/27/08	Text edits.
1.11	06/05/08	Edited the Application drawing on page 1.
1.12	09/19/08	Text edits.
1.13	02/11/09	Text edits.
1.14	02/19/09	Deleted the "Clarisound™" symbol from the D/S.
1.15	02/26/09	Deleted the "Clarisound™" label from the Typical Application circuit diagram.

Physical Dimensions inches (millimeters) unless otherwise noted

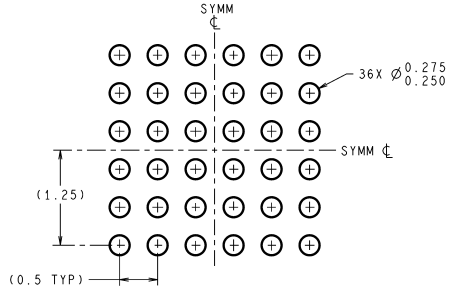

LAND PATTERN RECOMMENDATION

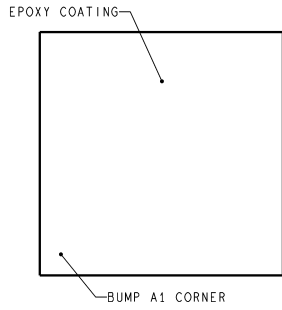

DIMENSIONS ARE IN MILLIMETERS
DIMENSIONS IN () FOR REFERENCE ONLY

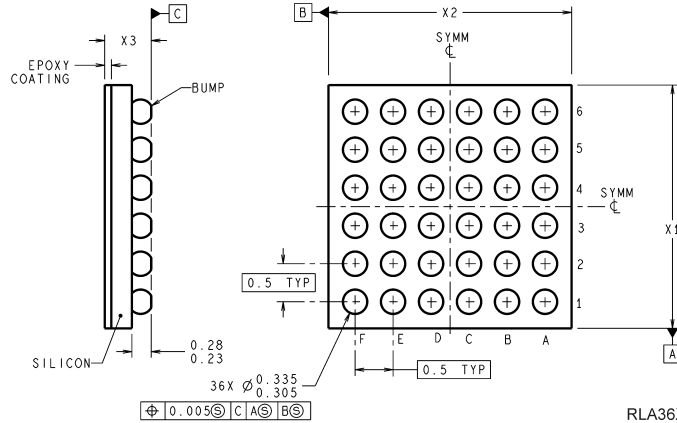

RLA36XXX (Rev A)

36 Bump micro SMD Technology
NS Package Number RLA36TTA
 $X_1 = 3.459 \pm 0.03$, $X_2 = 3.459 \pm 0.03$, $X_3 = 0.6 \pm 0.075$

Notes

For more National Semiconductor product information and proven design tools, visit the following Web sites at:

Products		Design Support	
Amplifiers	www.national.com/amplifiers	WEBENCH® Tools	www.national.com/webench
Audio	www.national.com/audio	App Notes	www.national.com/appnotes
Clock and Timing	www.national.com/timing	Reference Designs	www.national.com/refdesigns
Data Converters	www.national.com/adc	Samples	www.national.com/samples
Interface	www.national.com/interface	Eval Boards	www.national.com/evalboards
LVDS	www.national.com/lvds	Packaging	www.national.com/packaging
Power Management	www.national.com/power	Green Compliance	www.national.com/quality/green
Switching Regulators	www.national.com/switchers	Distributors	www.national.com/contacts
LDOs	www.national.com/ldo	Quality and Reliability	www.national.com/quality
LED Lighting	www.national.com/led	Feedback/Support	www.national.com/feedback
Voltage Reference	www.national.com/vref	Design Made Easy	www.national.com/easy
PowerWise® Solutions	www.national.com/powerwise	Solutions	www.national.com/solutions
Serial Digital Interface (SDI)	www.national.com/sdi	Mil/Aero	www.national.com/milaero
Temperature Sensors	www.national.com/tempsensors	SolarMagic™	www.national.com/solarmagic
Wireless (PLL/VCO)	www.national.com/wireless	Analog University®	www.national.com/AU

THE CONTENTS OF THIS DOCUMENT ARE PROVIDED IN CONNECTION WITH NATIONAL SEMICONDUCTOR CORPORATION ("NATIONAL") PRODUCTS. NATIONAL MAKES NO REPRESENTATIONS OR WARRANTIES WITH RESPECT TO THE ACCURACY OR COMPLETENESS OF THE CONTENTS OF THIS PUBLICATION AND RESERVES THE RIGHT TO MAKE CHANGES TO SPECIFICATIONS AND PRODUCT DESCRIPTIONS AT ANY TIME WITHOUT NOTICE. NO LICENSE, WHETHER EXPRESS, IMPLIED, ARISING BY ESTOPPEL OR OTHERWISE, TO ANY INTELLECTUAL PROPERTY RIGHTS IS GRANTED BY THIS DOCUMENT.

TESTING AND OTHER QUALITY CONTROLS ARE USED TO THE EXTENT NATIONAL DEEMS NECESSARY TO SUPPORT NATIONAL'S PRODUCT WARRANTY. EXCEPT WHERE MANDATED BY GOVERNMENT REQUIREMENTS, TESTING OF ALL PARAMETERS OF EACH PRODUCT IS NOT NECESSARILY PERFORMED. NATIONAL ASSUMES NO LIABILITY FOR APPLICATIONS ASSISTANCE OR BUYER PRODUCT DESIGN. BUYERS ARE RESPONSIBLE FOR THEIR PRODUCTS AND APPLICATIONS USING NATIONAL COMPONENTS. PRIOR TO USING OR DISTRIBUTING ANY PRODUCTS THAT INCLUDE NATIONAL COMPONENTS, BUYERS SHOULD PROVIDE ADEQUATE DESIGN, TESTING AND OPERATING SAFEGUARDS.

EXCEPT AS PROVIDED IN NATIONAL'S TERMS AND CONDITIONS OF SALE FOR SUCH PRODUCTS, NATIONAL ASSUMES NO LIABILITY WHATSOEVER, AND NATIONAL DISCLAIMS ANY EXPRESS OR IMPLIED WARRANTY RELATING TO THE SALE AND/OR USE OF NATIONAL PRODUCTS INCLUDING LIABILITY OR WARRANTIES RELATING TO FITNESS FOR A PARTICULAR PURPOSE, MERCHANTABILITY, OR INFRINGEMENT OF ANY PATENT, COPYRIGHT OR OTHER INTELLECTUAL PROPERTY RIGHT.

LIFE SUPPORT POLICY

NATIONAL'S PRODUCTS ARE NOT AUTHORIZED FOR USE AS CRITICAL COMPONENTS IN LIFE SUPPORT DEVICES OR SYSTEMS WITHOUT THE EXPRESS PRIOR WRITTEN APPROVAL OF THE CHIEF EXECUTIVE OFFICER AND GENERAL COUNSEL OF NATIONAL SEMICONDUCTOR CORPORATION. As used herein:

Life support devices or systems are devices which (a) are intended for surgical implant into the body, or (b) support or sustain life and whose failure to perform when properly used in accordance with instructions for use provided in the labeling can be reasonably expected to result in a significant injury to the user. A critical component is any component in a life support device or system whose failure to perform can be reasonably expected to cause the failure of the life support device or system or to affect its safety or effectiveness.

National Semiconductor and the National Semiconductor logo are registered trademarks of National Semiconductor Corporation. All other brand or product names may be trademarks or registered trademarks of their respective holders.

Copyright© 2009 National Semiconductor Corporation

For the most current product information visit us at www.national.com



National Semiconductor Americas Technical Support Center
 Email: support@nsc.com
 Tel: 1-800-272-9959

National Semiconductor Europe Technical Support Center
 Email: europe.support@nsc.com

National Semiconductor Asia Pacific Technical Support Center
 Email: ap.support@nsc.com

National Semiconductor Japan Technical Support Center
 Email: jpn.feedback@nsc.com