

# PNP Epitaxial Silicon Transistor

## KSA916

### Features

- Audio Power Amplifier
- Driver Stage Amplifier
- Complement to KSC2316

### ABSOLUTE MAXIMUM RATINGS

(Values are at  $T_A = 25^\circ\text{C}$  unless otherwise noted.)

| Symbol    | Parameter                 | Value       | Unit             |
|-----------|---------------------------|-------------|------------------|
| $V_{CB0}$ | Collector-Base Voltage    | -120        | V                |
| $V_{CEO}$ | Collector-Emitter Voltage | -120        | V                |
| $V_{EBO}$ | Emitter-Base Voltage      | -5          | V                |
| $I_C$     | Collector Current         | -800        | mA               |
| $T_J$     | Junction Temperature      | 150         | $^\circ\text{C}$ |
| $T_{STG}$ | Storage Temperature       | -55 to +150 | $^\circ\text{C}$ |

Stresses exceeding those listed in the Maximum Ratings table may damage the device. If any of these limits are exceeded, device functionality should not be assumed, damage may occur and reliability may be affected.

### THERMAL CHARACTERISTICS

(Values are at  $T_A = 25^\circ\text{C}$  unless otherwise noted.) (Note 1)

| Symbol          | Parameter  | Value | Unit                      |
|-----------------|--|-------|---------------------------|
| $P_D$           | Power Dissipation, by $R_{\theta JA}$                | 900   | mW                        |
|                 | Power Dissipation, by $R_{\theta JC}$                | 3     | W                         |
|                 | Derate Above $25^\circ\text{C}$ , by $R_{\theta JA}$ | 7.2   | mW/ $^\circ\text{C}$      |
|                 | Derate Above $25^\circ\text{C}$ , by $R_{\theta JC}$ | 24    | mW/ $^\circ\text{C}$      |
| $R_{\theta JA}$ | Thermal Resistance, Junction-to-Ambient              | 130   | $^\circ\text{C}/\text{W}$ |
| $R_{\theta JC}$ | Thermal Resistance, Junction-to-Case                 | 41    | $^\circ\text{C}/\text{W}$ |

1. PCB size: FR-4, 76 mm  $\times$  114 mm  $\times$  1.57 mm (3.0 inch  $\times$  4.5 inch  $\times$  0.062 inch) with minimum land pattern size.



ON Semiconductor®

[www.onsemi.com](http://www.onsemi.com)

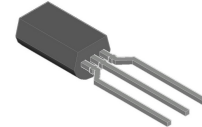

TO-92 3 LF  
CASE 135AM

### MARKING DIAGRAM

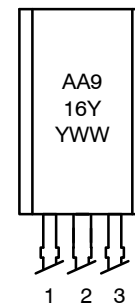

1: Emitter  
2: Collector  
3: Base

A = Assembly Code  
A916Y = Device Code  
YWW = Date Code

### ORDERING INFORMATION

| Device    | Package              | Shipping        |
|-----------|----------------------|-----------------|
| KSA916YTA | TO-92 3 LF (Pb-Free) | 2000 / Fan-Fold |

# KSA916

## ELECTRICAL CHARACTERISTICS

(Values are at  $T_A = 25^\circ\text{C}$  unless otherwise noted.)

| Symbol        | Parameter                            | Conditions   | Min. | Typ. | Max. | Unit          |
|---------------|--------------------------------------|--|------|------|------|---------------|
| $BV_{CBO}$    | Collector-Base Breakdown Voltage     | $I_C = -1\text{ mA}, I_E = 0$                      | -120 | -    | -    | V             |
| $BV_{CEO}$    | Collector-Emitter Breakdown Voltage  | $I_C = -10\text{ mA}, I_B = 0$                     | -120 | -    | -    | V             |
| $BV_{EBO}$    | Emitter-Base Breakdown Voltage       | $I_E = -1\text{ mA}, I_C = 0$                      | -5   | -    | -    | V             |
| $I_{CBO}$     | Collector Cut-Off Current            | $V_{CB} = -120\text{ V}, I_E = 0$                  | -    | -    | -0.1 | $\mu\text{A}$ |
| $h_{FE1}$     | DC Current Gain                      | $V_{CE} = -5\text{ V}, I_C = -10\text{ mA}$        | 60   | -    | -    |               |
| $h_{FE2}$     | DC Current Gain                      | $V_{CE} = -5\text{ V}, I_C = -100\text{ mA}$       | 80   | -    | 240  |               |
| $V_{CE(sat)}$ | Collector-Emitter Saturation Voltage | $I_C = -500\text{ mA}, I_B = -50\text{ mA}$        | -    | -    | -1   | V             |
| $f_T$         | Current Gain Bandwidth Product       | $V_{CE} = -5\text{ V}, I_C = -100\text{ mA}$       | -    | 120  | -    | MHz           |
| $C_{ob}$      | Output Capacitance                   | $V_{CB} = -10\text{ V}, I_E = 0, f = 1\text{ MHz}$ | -    | -    | 40   | pF            |

Product parametric performance is indicated in the Electrical Characteristics for the listed test conditions, unless otherwise noted. Product performance may not be indicated by the Electrical Characteristics if operated under different conditions.

## $h_{FE}$ CLASSIFICATION

| Classification | O        | Y         |
|----------------|----------|-----------|
| $h_{FE2}$      | 80 ~ 160 | 120 ~ 240 |

TYPICAL PERFORMANCE CHARACTERISTICS

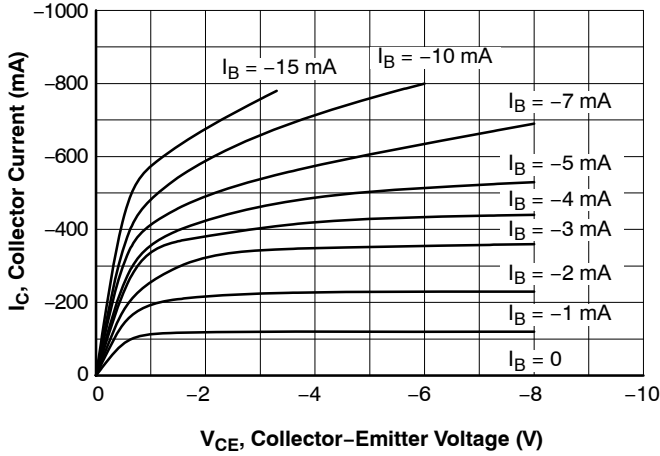

Figure 1. Static Characteristic

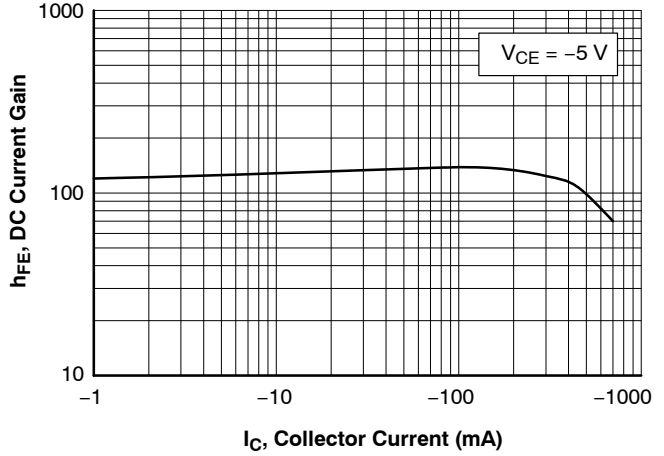

Figure 2. DC Current Gain

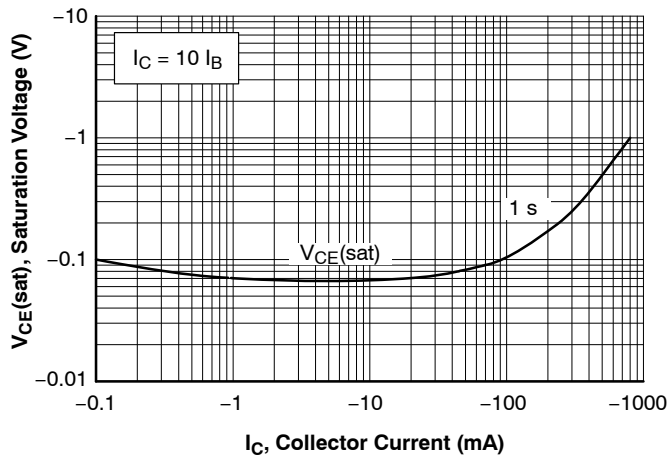

Figure 3. Collector-Emitter Saturation Voltage

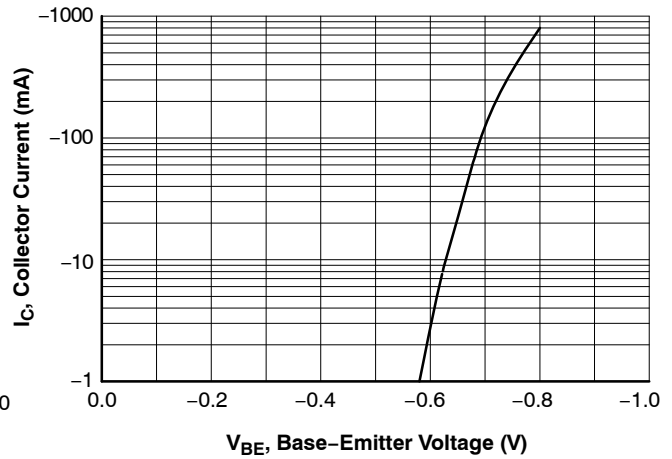

Figure 4. Base-Emitter On Voltage

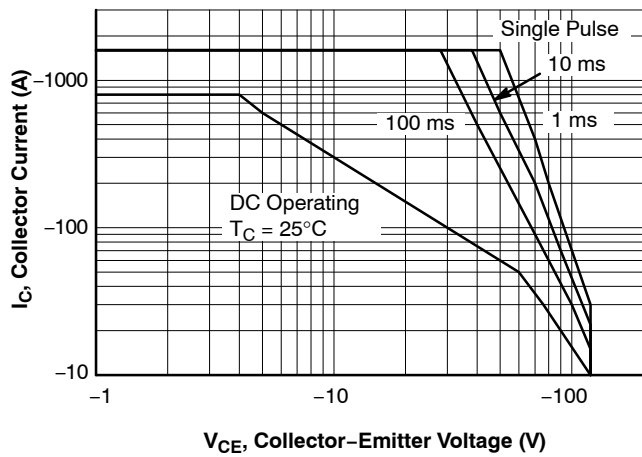

Figure 5. Safe Operating Area

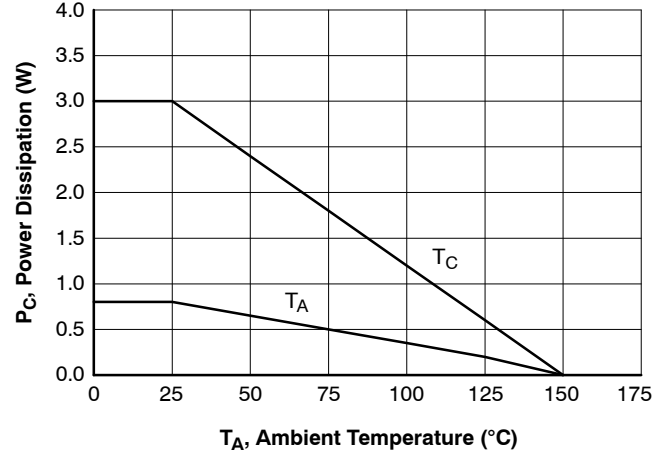
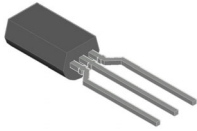

Figure 6. Power Derating

# MECHANICAL CASE OUTLINE

## PACKAGE DIMENSIONS

ON Semiconductor®



### TO-92 3 8.0x4.9 (LEADFORMED)

CASE 135AM  
ISSUE B

DATE 14 JAN 2021

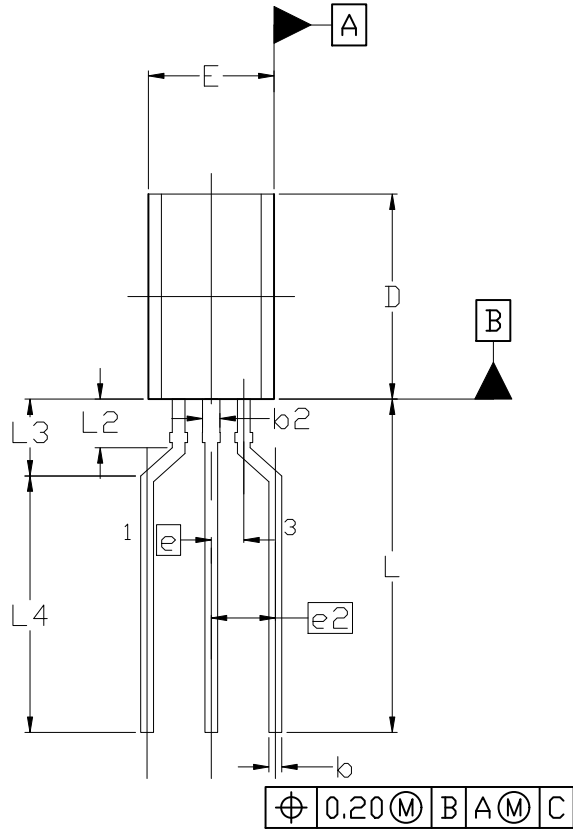

TOP VIEW

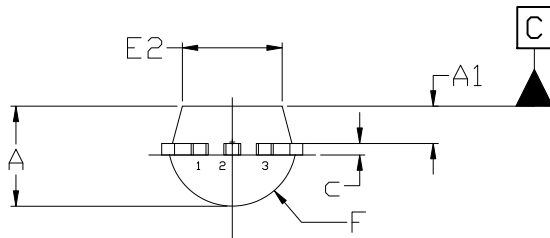

END VIEW

NOTES:

1. DIMENSIONING AND TOLERANCING PER ASME Y14.5M, 2009.
2. CONTROLLING DIMENSION: MILLIMETERS
3. DIMENSIONS ARE EXCLUSIVE OF BURRS, MOLD FLASH, GATE REMAINS AND TIE BAR PROTRUSIONS.
4. DIMENSION b AND b2 DOES NOT INCLUDE DAMBAR PROTRUSION. DIMENSION b2 LOCATED ABOVE THE DAMBAR PORTION OF MIDDLE LEAD.

| DIM | MILLIMETERS |      |      |
|-----|-------------|------|------|
|     | MIN.        | NOM. | MAX. |
| A   | 3.70        | 3.90 | 4.10 |
| A1  | 1.25        | 1.45 | 1.65 |
| b   | 0.35        | 0.50 | 0.60 |
| b2  | 0.62        | ---  | 0.78 |
| c   | 0.35        | 0.45 | 0.55 |
| D   | 7.80        | 8.00 | 8.20 |
| E   | 4.70        | 4.90 | 5.10 |
| E2  | 3.70        | 3.90 | 4.10 |
| e   | 1.27 BSC    |      |      |
| e2  | 2.50 BSC    |      |      |
| F   | 2.45 REF    |      |      |
| L   | 13.00 REF   |      |      |
| L2  | 1.50        | ---  | 1.90 |
| L3  | 2.60        | ---  | 3.40 |
| L4  | 10.40 REF   |      |      |

|                         |                                     |  |
|-------------------------|-------------------------------------|--|
| <b>DOCUMENT NUMBER:</b> | <b>98AON14058G</b>                  | Electronic versions are uncontrolled except when accessed directly from the Document Repository. Printed versions are uncontrolled except when stamped "CONTROLLED COPY" in red. |
| <b>DESCRIPTION:</b>     | <b>TO-92 3 8.0X4.9 (LEADFORMED)</b> | <b>PAGE 1 OF 1</b>   |

ON Semiconductor and are trademarks of Semiconductor Components Industries, LLC dba ON Semiconductor or its subsidiaries in the United States and/or other countries. ON Semiconductor reserves the right to make changes without further notice to any products herein. ON Semiconductor makes no warranty, representation or guarantee regarding the suitability of its products for any particular purpose, nor does ON Semiconductor assume any liability arising out of the application or use of any product or circuit, and specifically disclaims any and all liability, including without limitation special, consequential or incidental damages. ON Semiconductor does not convey any license under its patent rights nor the rights of others.

**onsemi**, **Onsemi**, and other names, marks, and brands are registered and/or common law trademarks of Semiconductor Components Industries, LLC dba "**onsemi**" or its affiliates and/or subsidiaries in the United States and/or other countries. **onsemi** owns the rights to a number of patents, trademarks, copyrights, trade secrets, and other intellectual property. A listing of **onsemi**'s product/patent coverage may be accessed at [www.onsemi.com/site/pdf/Patent-Marking.pdf](http://www.onsemi.com/site/pdf/Patent-Marking.pdf). **onsemi** reserves the right to make changes at any time to any products or information herein, without notice. The information herein is provided "as-is" and **onsemi** makes no warranty, representation or guarantee regarding the accuracy of the information, product features, availability, functionality, or suitability of its products for any particular purpose, nor does **onsemi** assume any liability arising out of the application or use of any product or circuit, and specifically disclaims any and all liability, including without limitation special, consequential or incidental damages. Buyer is responsible for its products and applications using **onsemi** products, including compliance with all laws, regulations and safety requirements or standards, regardless of any support or applications information provided by **onsemi**. "Typical" parameters which may be provided in **onsemi** data sheets and/or specifications can and do vary in different applications and actual performance may vary over time. All operating parameters, including "Typicals" must be validated for each customer application by customer's technical experts. **onsemi** does not convey any license under any of its intellectual property rights nor the rights of others. **onsemi** products are not designed, intended, or authorized for use as a critical component in life support systems or any FDA Class 3 medical devices or medical devices with a same or similar classification in a foreign jurisdiction or any devices intended for implantation in the human body. Should Buyer purchase or use **onsemi** products for any such unintended or unauthorized application, Buyer shall indemnify and hold **onsemi** and its officers, employees, subsidiaries, affiliates, and distributors harmless against all claims, costs, damages, and expenses, and reasonable attorney fees arising out of, directly or indirectly, any claim of personal injury or death associated with such unintended or unauthorized use, even if such claim alleges that **onsemi** was negligent regarding the design or manufacture of the part. **onsemi** is an Equal Opportunity/Affirmative Action Employer. This literature is subject to all applicable copyright laws and is not for resale in any manner.

## PUBLICATION ORDERING INFORMATION

### LITERATURE FULFILLMENT:

Email Requests to: [orderlit@onsemi.com](mailto:orderlit@onsemi.com)

**onsemi Website:** [www.onsemi.com](http://www.onsemi.com)

### TECHNICAL SUPPORT

**North American Technical Support:**

Voice Mail: 1 800-282-9855 Toll Free USA/Canada

Phone: 011 421 33 790 2910

**Europe, Middle East and Africa Technical Support:**

Phone: 00421 33 790 2910

For additional information, please contact your local Sales Representative