

Trench gate field-stop 650 V, 60 A high speed HB series IGBT

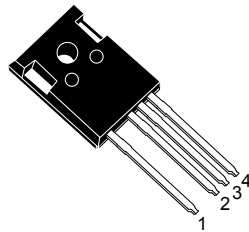

TO247-4

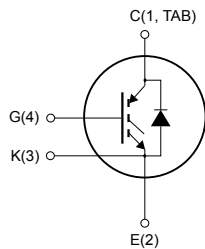

NG4K3E2C1_TAB



Product status link

[STGW60H65DFB-4](#)

Product summary

| | |
|-------------------|----------------|
| Order code | STGW60H65DFB-4 |
| Marking | G60H65DFB |
| Package | TO247-4 |
| Packing | Tube |

Features

- Maximum junction temperature: $T_J = 175\text{ °C}$
- Excellent switching performance thanks to the extra driving kelvin pin
- Low $V_{CE(sat)} = 1.6\text{ V (typ.) @ } I_C = 60\text{ A}$
- Minimized tail current
- Tight parameter distribution
- Safe paralleling
- Low thermal resistance
- Very fast soft recovery antiparallel diode

Applications

- Photovoltaic inverters
- High-frequency converters

Description

This device is an IGBT developed using an advanced proprietary trench gate field-stop structure. The device is part of the new HB series of IGBTs, which represents an optimum compromise between conduction and switching loss to maximize the efficiency of any frequency converter. A faster switching event can be achieved by the Kelvin pin, which separates power path from driving signal. Furthermore, the slightly positive $V_{CE(sat)}$ temperature coefficient and very tight parameter distribution result in safer paralleling operation.

1 Electrical ratings

Table 1. Absolute maximum ratings

| Symbol | Parameter | Value | Unit |
|-------------------------|--|-------------------|------|
| V_{CES} | Collector-emitter voltage ($V_{GE} = 0$ V) | 650 | V |
| I_C | Continuous collector current at $T_C = 25$ °C | 80 ⁽¹⁾ | A |
| | Continuous collector current at $T_C = 100$ °C | 60 | |
| I_{CP} ⁽²⁾ | Pulsed collector current | 240 | A |
| V_{GE} | Gate-emitter voltage | ±20 | V |
| | Transient gate-emitter voltage | ±30 | |
| I_F | Continuous forward current at $T_C = 25$ °C | 80 ⁽¹⁾ | A |
| | Continuous forward current at $T_C = 100$ °C | 60 | |
| I_{FP} ⁽²⁾ | Pulsed forward current | 240 | A |
| P_{TOT} | Total power dissipation at $T_C = 25$ °C | 375 | W |
| T_{STG} | Storage temperature range | -55 to 150 | °C |
| T_J | Operating junction temperature range | -55 to 175 | |

1. Current level is limited by bond wires.
2. Pulse width is limited by maximum junction temperature.

Table 2. Thermal data

| Symbol | Parameter | Value | Unit |
|------------|--|-------|------|
| R_{thJC} | Thermal resistance junction-case IGBT | 0.4 | °C/W |
| R_{thJC} | Thermal resistance junction-case diode | 1.14 | |
| R_{thJA} | Thermal resistance junction-ambient | 50 | |

2 Electrical characteristics

$T_C = 25\text{ °C}$ unless otherwise specified

Table 3. Static characteristics

| Symbol | Parameter | Test conditions | Min. | Typ. | Max. | Unit |
|---------------|--------------------------------------|--|------|------|-----------|---------------|
| $V_{(BR)CES}$ | Collector-emitter breakdown voltage | $V_{GE} = 0\text{ V}, I_C = 2\text{ mA}$ | 650 | | | V |
| $V_{CE(sat)}$ | Collector-emitter saturation voltage | $V_{GE} = 15\text{ V}, I_C = 60\text{ A}$ | | 1.6 | 2.0 | V |
| | | $V_{GE} = 15\text{ V}, I_C = 60\text{ A}, T_J = 125\text{ °C}$ | | 1.75 | | |
| | | $V_{GE} = 15\text{ V}, I_C = 60\text{ A}, T_J = 175\text{ °C}$ | | 1.85 | | |
| V_F | Forward on-voltage | $I_F = 60\text{ A}$ | | 2 | 2.6 | V |
| | | $I_F = 60\text{ A}, T_J = 125\text{ °C}$ | | 1.7 | | |
| | | $I_F = 60\text{ A}, T_J = 175\text{ °C}$ | | 1.6 | | |
| $V_{GE(th)}$ | Gate threshold voltage | $V_{CE} = V_{GE}, I_C = 1\text{ mA}$ | 5 | 6 | 7 | V |
| I_{CES} | Collector cut-off current | $V_{GE} = 0\text{ V}, V_{CE} = 650\text{ V}$ | | | 25 | μA |
| I_{GES} | Gate-emitter leakage current | $V_{CE} = 0\text{ V}, V_{GE} = \pm 20\text{ V}$ | | | ± 250 | nA |

Table 4. Dynamic characteristics

| Symbol | Parameter | Test conditions | Min. | Typ. | Max. | Unit |
|-----------|------------------------------|--|------|------|------|------|
| C_{ies} | Input capacitance | $V_{CE} = 25\text{ V}, f = 1\text{ MHz}, V_{GE} = 0\text{ V}$ | - | 7792 | - | nF |
| C_{oes} | Output capacitance | | - | 262 | - | |
| C_{res} | Reverse transfer capacitance | | - | 158 | - | |
| Q_g | Total gate charge | $V_{CC} = 520\text{ V}, I_C = 60\text{ A}, V_{GE} = 0$ to 15 V (see Figure 29. Gate charge test circuit) | - | 306 | - | nC |
| Q_{ge} | Gate-emitter charge | | - | 126 | - | |
| Q_{gc} | Gate-collector charge | | - | 58 | - | |

Table 5. IGBT switching characteristics (inductive load)

| Symbol | Parameter | Test conditions | Min. | Typ. | Max. | Unit |
|-----------------|---------------------------|---|------|------|---------------|------------------|
| $t_{d(on)}$ | Turn-on delay time | $V_{CE} = 400\text{ V}$, $I_C = 60\text{ A}$, $V_{GE} = 15\text{ V}$, $R_G = 10\ \Omega$ (see Figure 28. Test circuit for inductive load switching) | - | 65 | - | ns |
| t_r | Current rise time | | - | 26 | - | ns |
| $(di/dt)_{on}$ | Turn-on current slope | | - | 1846 | - | A/ μs |
| $t_{d(off)}$ | Turn-off-delay time | | - | 261 | - | ns |
| t_f | Current fall time | | - | 21 | - | ns |
| $E_{on}^{(1)}$ | Turn-on switching energy | | - | 346 | - | μJ |
| $E_{off}^{(2)}$ | Turn-off switching energy | | - | 1161 | - | μJ |
| E_{ts} | Total switching energy | - | 1507 | - | μJ | |
| $t_{d(on)}$ | Turn-on delay time | $V_{CE} = 400\text{ V}$, $I_C = 60\text{ A}$, $V_{GE} = 15\text{ V}$, $R_G = 10\ \Omega$ $T_J = 175\text{ }^\circ\text{C}$ (see Figure 28. Test circuit for inductive load switching) | - | 61 | - | ns |
| t_r | Current rise time | | - | 30 | - | ns |
| $(di/dt)_{on}$ | Turn-on current slope | | - | 1640 | - | A/ μs |
| $t_{d(off)}$ | Turn-off-delay time | | - | 284 | - | ns |
| t_f | Current fall time | | - | 45 | - | ns |
| $E_{on}^{(1)}$ | Turn-on switching energy | | - | 644 | - | μJ |
| $E_{off}^{(2)}$ | Turn-off switching energy | | - | 1633 | - | μJ |
| E_{ts} | Total switching energy | - | 2277 | - | μJ | |

1. Including the reverse recovery of the diode.
2. Including the tail of the collector current.

Table 6. Diode switching characteristics (inductive load)

| Symbol | Parameter | Test conditions | Min. | Typ. | Max. | Unit |
|--------------|--|--|------|------|------|------------------|
| t_{rr} | Reverse recovery time | $I_F = 60\text{ A}$, $V_R = 400\text{ V}$, $V_{GE} = 15\text{ V}$, $di/dt = 1000\text{ A}/\mu\text{s}$ (see Figure 28. Test circuit for inductive load switching) | - | 60 | - | ns |
| Q_{rr} | Reverse recovery charge | | - | 99 | - | nC |
| I_{rrm} | Reverse recovery current | | - | 3.3 | - | A |
| dI_{rr}/dt | Peak rate of fall of reverse recovery current during t_b | | - | 187 | - | A/ μs |
| E_{rr} | Reverse recovery energy | | - | 68 | - | μJ |
| t_{rr} | Reverse recovery time | $I_F = 60\text{ A}$, $V_R = 400\text{ V}$, $V_{GE} = 15\text{ V}$, $di/dt = 1000\text{ A}/\mu\text{s}$, $T_J = 175\text{ }^\circ\text{C}$ (see Figure 28. Test circuit for inductive load switching) | - | 310 | - | ns |
| Q_{rr} | Reverse recovery charge | | - | 1550 | - | nC |
| I_{rrm} | Reverse recovery current | | - | 10 | - | A |
| dI_{rr}/dt | Peak rate of fall of reverse recovery current during t_b | | - | 59 | - | A/ μs |
| E_{rr} | Reverse recovery energy | | - | 674 | - | μJ |

2.1 Electrical characteristics (curves)

Figure 1. Power dissipation vs. case temperature

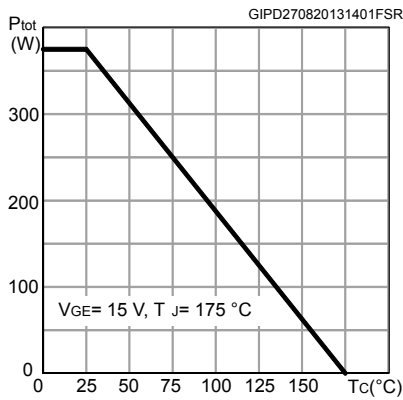

Figure 2. Collector current vs. case temperature

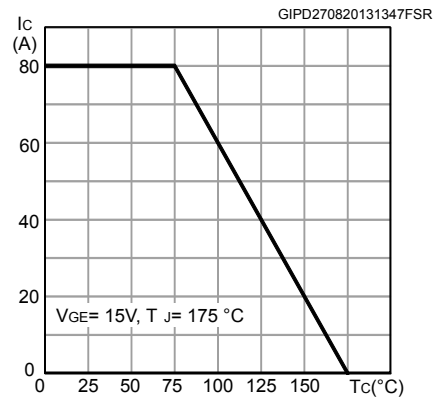

Figure 3. Output characteristics ($T_J = 25\text{ }^\circ\text{C}$)

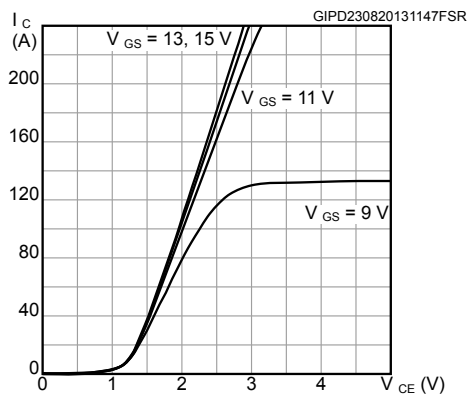

Figure 4. Output characteristics ($T_J = 175\text{ }^\circ\text{C}$)

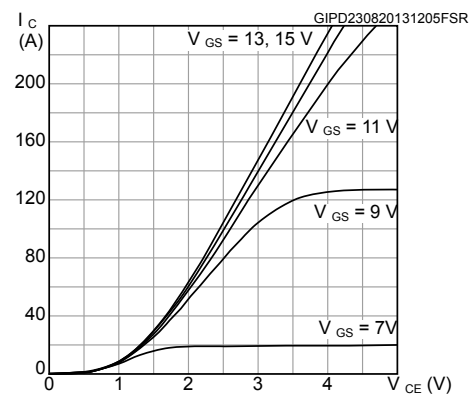

Figure 5. $V_{CE(sat)}$ vs. junction temperature

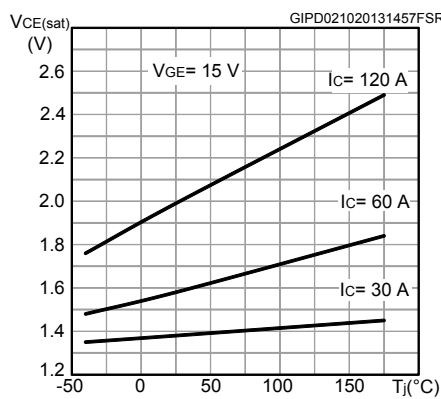

Figure 6. $V_{CE(sat)}$ vs. collector current

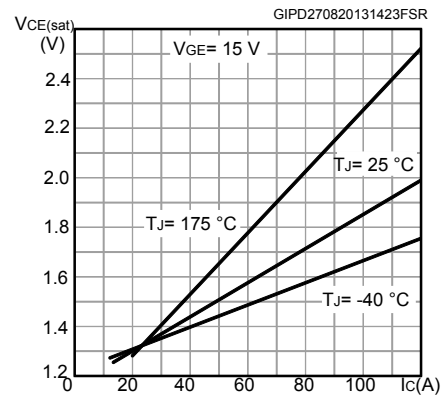

Figure 7. Collector current vs. switching frequency

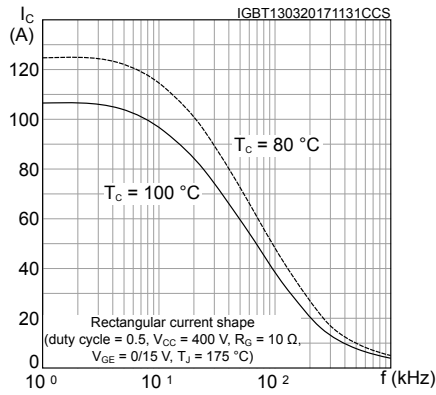

Figure 8. Forward bias safe operating area

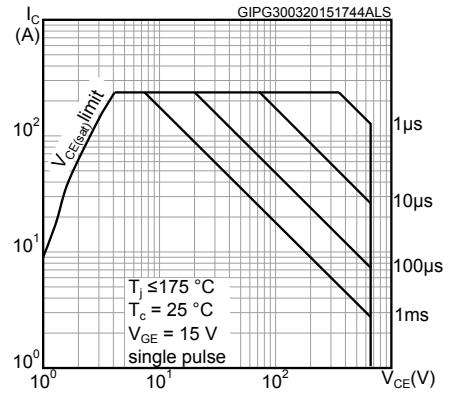

Figure 9. Transfer characteristics

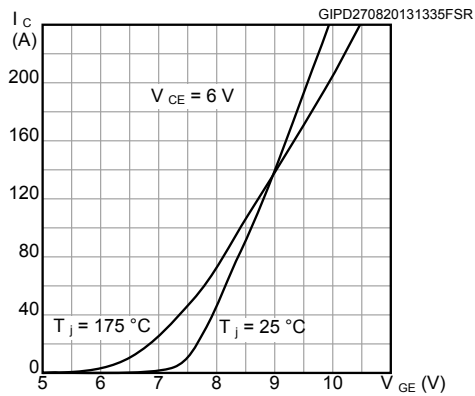

Figure 10. Diode VF vs. forward current

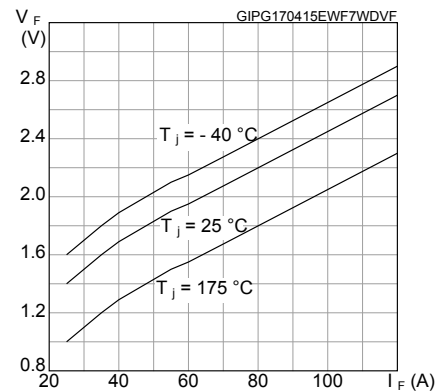

Figure 11. Normalized VGE(th) vs. junction temperature

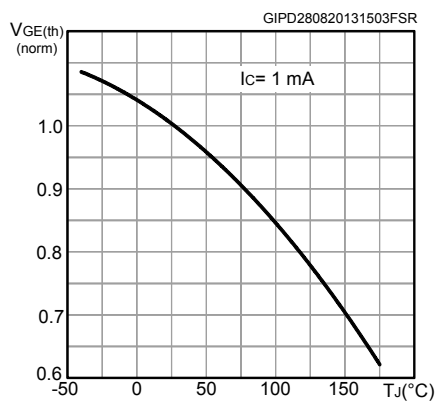

Figure 12. Normalized V(BR)CES vs. junction temperature

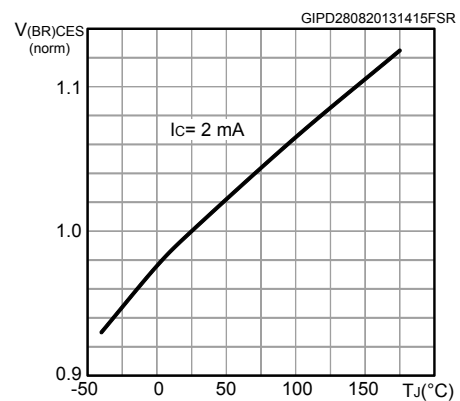

Figure 13. Capacitance variations

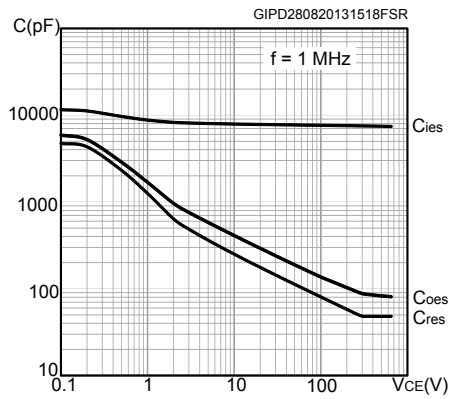

Figure 14. Gate charge vs. gate-emitter voltage

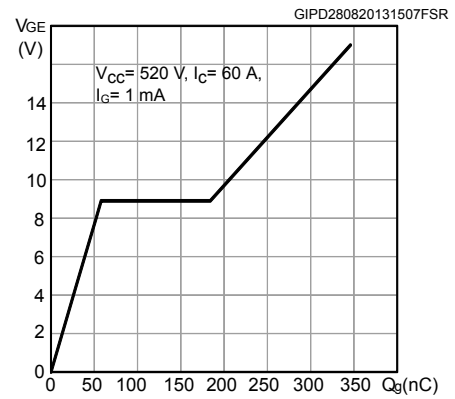

Figure 15. Switching energy vs. collector current

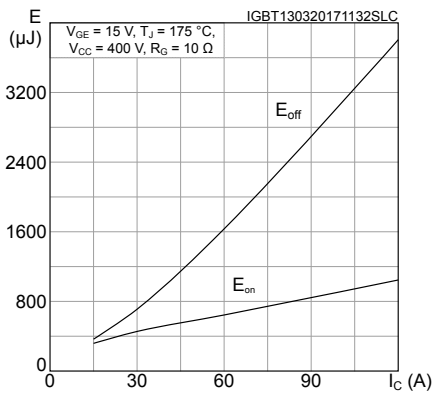

Figure 16. Switching energy vs. gate resistance

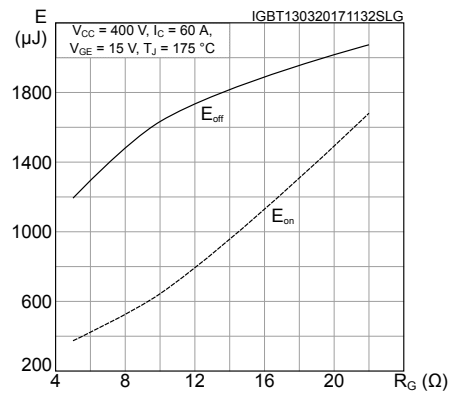

Figure 17. Switching energy vs. temperature

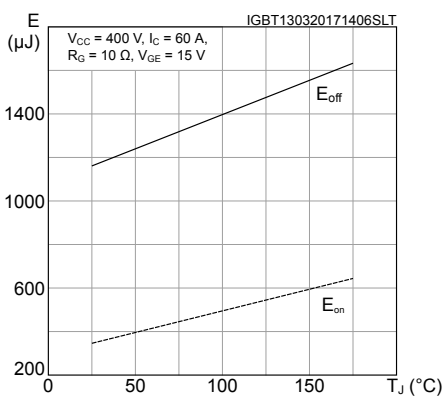

Figure 18. Switching energy vs. collector emitter voltage

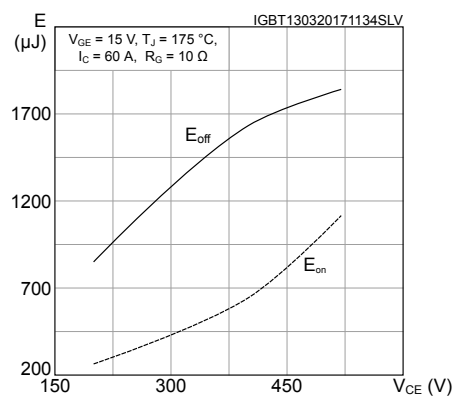

Figure 19. Switching times vs. collector current

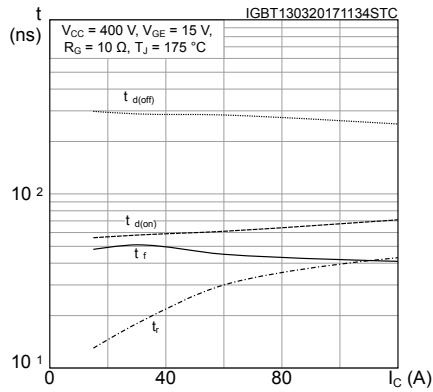

Figure 20. Switching times vs. gate resistance

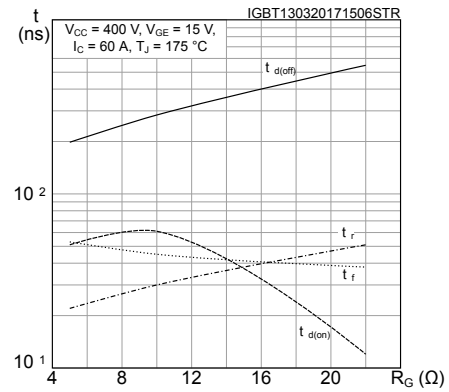

Figure 21. Reverse recovery current vs. diode current slope

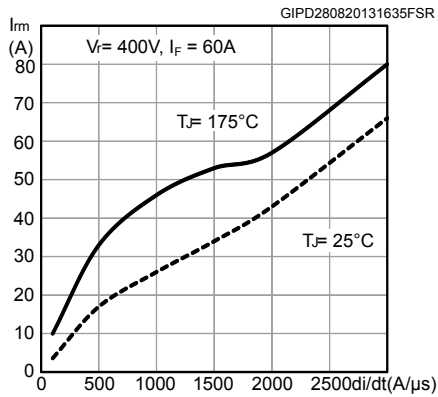

Figure 22. Reverse recovery time vs. diode current slope

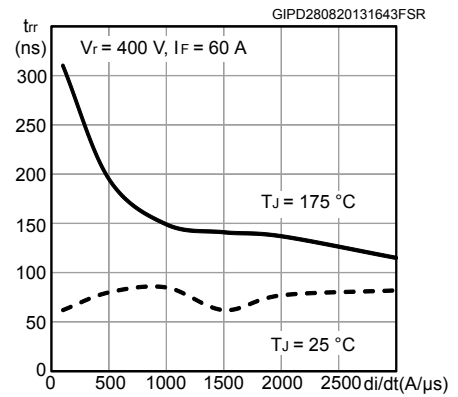

Figure 23. Reverse recovery charge vs. diode current slope

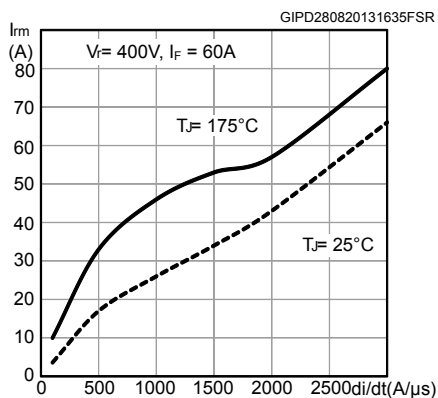

Figure 24. Reverse recovery energy vs. diode current slope

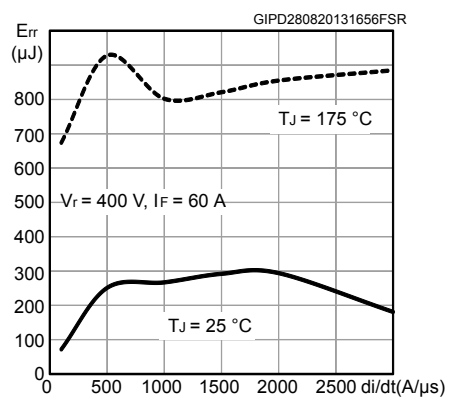

Figure 25. Thermal impedance for IGBT

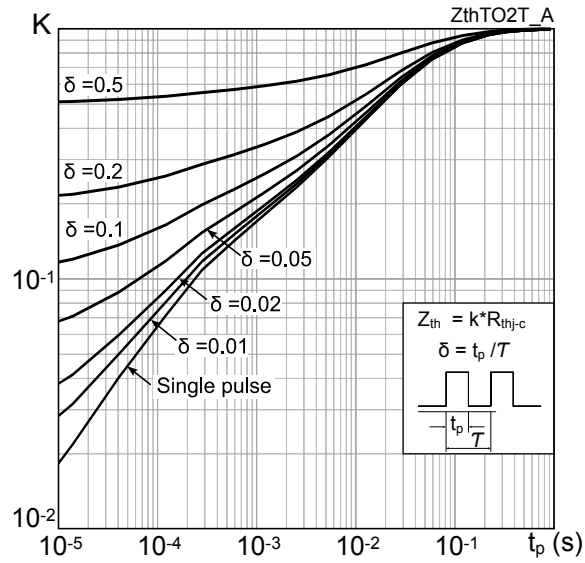
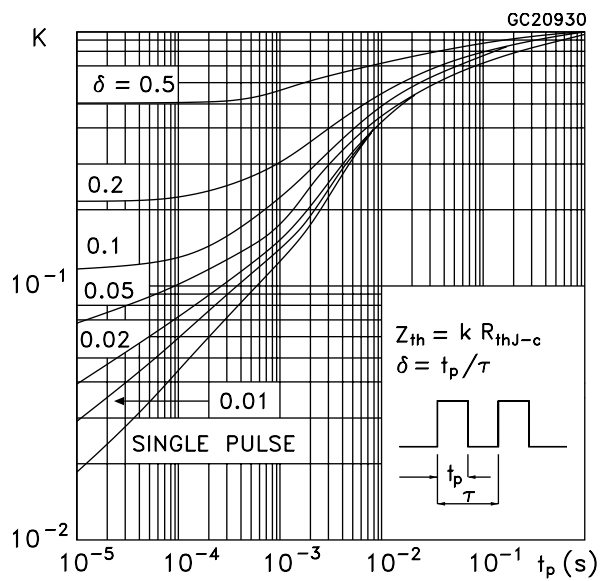

Figure 26. Thermal impedance for diode



3 Test circuits

Figure 27. Test circuit for inductive load switching

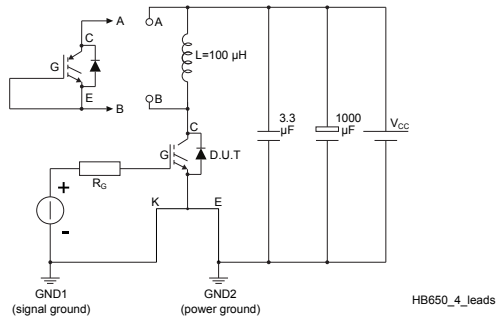

Figure 28. Gate charge test circuit

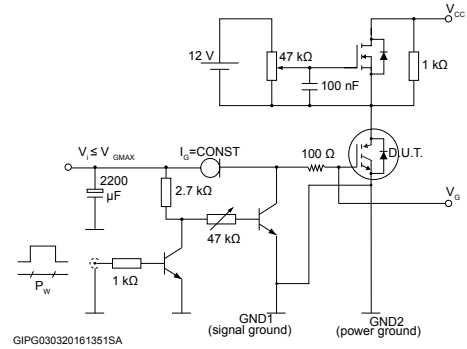

Figure 29. Switching waveform

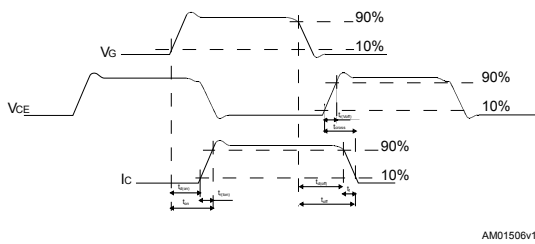
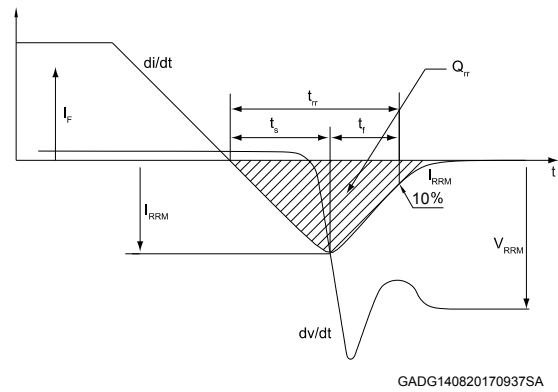

Figure 30. Diode reverse recovery waveform



4 Package information

In order to meet environmental requirements, ST offers these devices in different grades of **ECOPACK** packages, depending on their level of environmental compliance. ECOPACK specifications, grade definitions and product status are available at: www.st.com. ECOPACK is an ST trademark.

4.1 TO247-4 package information

Figure 31. TO247-4 package outline

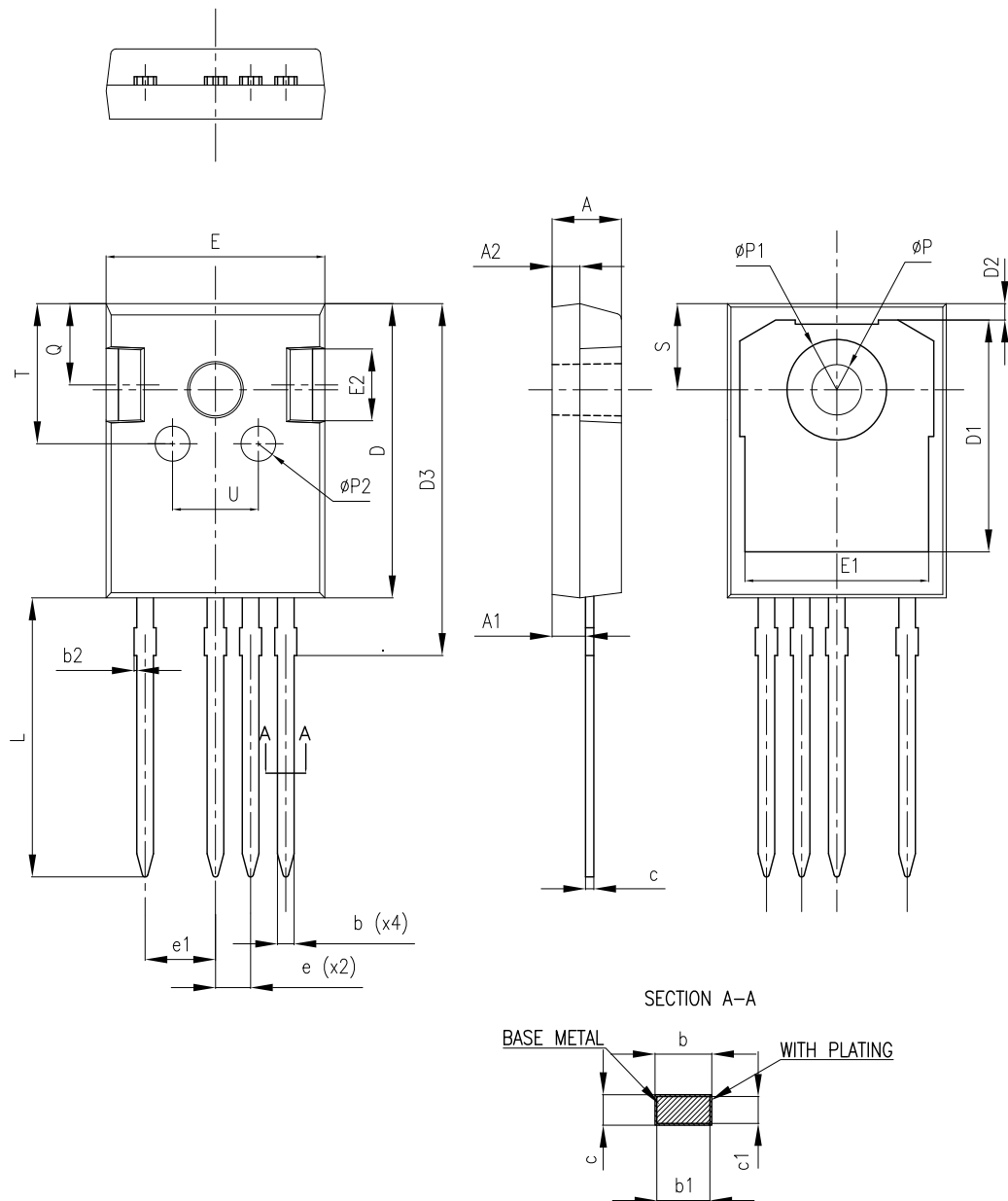

8405626_2

Table 7. TO247-4 mechanical data

| Dim. | mm | | |
|------|-------|-------|-------|
| | Min. | Typ. | Max. |
| A | 4.90 | 5.00 | 5.10 |
| A1 | 2.31 | 2.41 | 2.51 |
| A2 | 1.90 | 2.00 | 2.10 |
| b | 1.16 | | 1.29 |
| b1 | 1.15 | 1.20 | 1.25 |
| b2 | 0 | | 0.20 |
| c | 0.59 | | 0.66 |
| c1 | 0.58 | 0.60 | 0.62 |
| D | 20.90 | 21.00 | 21.10 |
| D1 | 16.25 | 16.55 | 16.85 |
| D2 | 1.05 | 1.20 | 1.35 |
| D3 | 24.97 | 25.12 | 25.27 |
| E | 15.70 | 15.80 | 15.90 |
| E1 | 13.10 | 13.30 | 13.50 |
| E2 | 4.90 | 5.00 | 5.10 |
| E3 | 2.40 | 2.50 | 2.60 |
| e | 2.44 | 2.54 | 2.64 |
| e1 | 4.98 | 5.08 | 5.18 |
| L | 19.80 | 19.92 | 20.10 |
| P | 3.50 | 3.60 | 3.70 |
| P1 | | | 7.40 |
| P2 | 2.40 | 2.50 | 2.60 |
| Q | 5.60 | | 6.00 |
| S | | 6.15 | |
| T | 9.80 | | 10.20 |
| U | 6.00 | | 6.40 |

Revision history

Table 8. Document revision history

| Date | Revision | Changes |
|-------------|----------|---|
| 30-May-2016 | 1 | First release. |
| 21-Mar-2017 | 2 | Updated <i>Table Absolute maximum ratings</i> and <i>Table IGBT switching characteristics (inductive load)</i> . Updated <i>Section STGW60H65DFB-4 electrical characteristics curves</i> . Minor text changes |
| 20-Jun-2019 | 3 | Updated title. Updated Section Features and schematic diagram in cover page. Updated Table 1. Absolute maximum ratings . Minor text changes. |

Contents

| | | |
|------------|--|-----------|
| 1 | Electrical ratings | 2 |
| 2 | Electrical characteristics | 3 |
| 2.1 | Electrical characteristics (curves) | 4 |
| 3 | Test circuits | 10 |
| 4 | Package information | 11 |
| 4.1 | TO247-4 package information | 11 |
| | Revision history | 13 |

IMPORTANT NOTICE – PLEASE READ CAREFULLY

STMicroelectronics NV and its subsidiaries (“ST”) reserve the right to make changes, corrections, enhancements, modifications, and improvements to ST products and/or to this document at any time without notice. Purchasers should obtain the latest relevant information on ST products before placing orders. ST products are sold pursuant to ST’s terms and conditions of sale in place at the time of order acknowledgement.

Purchasers are solely responsible for the choice, selection, and use of ST products and ST assumes no liability for application assistance or the design of Purchasers’ products.

No license, express or implied, to any intellectual property right is granted by ST herein.

Resale of ST products with provisions different from the information set forth herein shall void any warranty granted by ST for such product.

ST and the ST logo are trademarks of ST. For additional information about ST trademarks, please refer to www.st.com/trademarks. All other product or service names are the property of their respective owners.

Information in this document supersedes and replaces information previously supplied in any prior versions of this document.

© 2019 STMicroelectronics – All rights reserved