

SMJ4256

262,144-BIT DYNAMIC RANDOM-ACCESS MEMORY

NOVEMBER 1985 — REVISED NOVEMBER 1989

- 262,144 × 1 Organization
- Single 5-V Supply
- JEDEC Standardized Pinout
- Upward Pin Compatible with SMJ4164 (64K Dynamic RAM)
- Performance Ranges:

	ACCESS TIME ROW ADDRESS (MAX)	ACCESS TIME COLUMN ADDRESS (MAX)	READ OR WRITE CYCLE (MIN)
SMJ4256-12	120 ns	65 ns	230 ns
SMJ4256-15	150 ns	80 ns	260 ns
SMJ4256-20	200 ns	100 ns	330 ns

- Long Refresh Period . . . 4 ms (Max)
- Low Refresh Overhead Time . . . As Low As 1.3% of Total Refresh Period
- On-Chip Substrate Bias Generator
- All Inputs, Outputs, and Clocks Fully TTL Compatible
- 3-State Unlatched Output
- Common I/O Capability with "Early Write" Feature
- Power Dissipation as Low As
 - Operating . . . 300 mW (Typ)
 - Standby . . . 12.5 mW (Typ)
- MIL-STD-883C Class B High-Reliability Processing
- \overline{RAS} -Only Refresh Mode
- Hidden Refresh Mode
- \overline{CAS} -Before- \overline{RAS} Refresh Mode
- Full Military DRAM Temperature Range Operation . . . -55°C to 110°C

JD PACKAGE
(TOP VIEW)

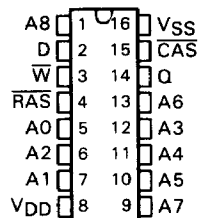

FV PACKAGE
(TOP VIEW)

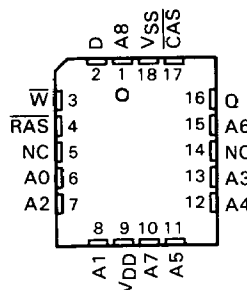

PIN NOMENCLATURE

A0-A8	Address Inputs
\overline{CAS}	Column-Address Strobe
D	Data In
NC	No Connect
Q	Data Out
\overline{RAS}	Row-Address Strobe
VDD	5-V Supply
VSS	Ground
W	Write Enable

description

The SMJ4256 is a high-speed, 262,144-bit dynamic random-access memory, organized as 262,144 words of one bit each. It employs state-of-the-art SMOS (scaled MOS) N-channel double-level polysilicon/polycide gate technology for very high performance combined with low cost and improved reliability.

The SMJ4256 features maximum \overline{RAS} access times of 120 ns, 150 ns, or 200 ns. Typical power dissipation is as low as 300 mW operating and 12.5 mW standby.

New SMOS technology permits operation from a single 5-V supply, reducing system power supply and decoupling requirements, and easing board layout. I_{DD} peaks are 125 mA typical, and a -0.5-V input voltage undershoot can be tolerated, minimizing system noise considerations.

PRODUCTION DATA documents contain information current as of publication date. Products conform to specifications per the terms of Texas Instruments standard warranty. Production processing does not necessarily include testing of all parameters.

**TEXAS
INSTRUMENTS**

POST OFFICE BOX 225012 • DALLAS, TEXAS 75265

Copyright © 1985, Texas Instruments Incorporated

14-529

SMJ4256

262,144-BIT DYNAMIC RANDOM-ACCESS MEMORY

All inputs and outputs, including clocks, are compatible with Series 54 TTL. All address and data-in lines are latched on-chip to simplify system design. Data out is unlatched to allow greater system flexibility.

The SMJ4256 is offered in 16-pin 300-mil ceramic side-braze dual-in-line and 18-pad ceramic chip carrier packages. It is guaranteed for operation from -55°C to 110°C . The dual-in-line package is designed for insertion in mounting-hole rows on 7,62-mm (300-mil) centers.

operation

address (A0 through A8)

Eighteen address bits are required to decode 1 of 262,144 storage cell locations. Nine row-address bits are set up on pins A0 through A8 and latched onto the chip by the row-address strobe ($\overline{\text{RAS}}$). Then the nine column-address bits are set up on pins A0 through A8 and latched onto the chip by the column-address strobe ($\overline{\text{CAS}}$). All addresses must be stable on or before the falling edge of $\overline{\text{RAS}}$ and $\overline{\text{CAS}}$. $\overline{\text{RAS}}$ is similar to a chip enable in that it activates the sense amplifiers as well as the row decoder. $\overline{\text{CAS}}$ is used as a chip select activating the column decoder and the input and output buffers.

write enable ($\overline{\text{W}}$)

The read or write mode is selected through the write-enable ($\overline{\text{W}}$) input. A logic high on the $\overline{\text{W}}$ input selects the read mode and a logic low selects the write mode. The write-enable terminal can be driven from standard TTL circuits without a pull-up resistor. The data input is disabled when the read mode is selected. When $\overline{\text{W}}$ goes low prior to $\overline{\text{CAS}}$, data out will remain in the high-impedance state for the entire cycle, permitting common I/O operation.

data in (D)

Data is written during a write or read-modify-write cycle. Depending on the mode of operation, the falling edge of $\overline{\text{CAS}}$ or $\overline{\text{W}}$ strobes data into the on-chip data latch. This latch can be driven from standard TTL circuits without a pull-up resistor. In an early write cycle, $\overline{\text{W}}$ is brought low prior to $\overline{\text{CAS}}$ and the data is strobed in by $\overline{\text{CAS}}$ with setup and hold times referenced to this signal. In a delayed-write or read-modify-write cycle, $\overline{\text{CAS}}$ will already be low, thus the data will be strobed in by $\overline{\text{W}}$ with setup and hold times referenced to this signal.

data out (Q)

The three-state output buffer provides direct TTL compatibility (no pull-up resistor required) with a fanout of two Series 54 TTL loads. Data out is the same polarity as data in. The output is in the high-impedance (floating) state until $\overline{\text{CAS}}$ is brought low. In a read cycle the output goes active after the access time interval $t_{a(C)}$ that begins with the negative transition of $\overline{\text{CAS}}$ as long as $t_{a(R)}$ is satisfied. The output becomes valid after the access time has elapsed and remains valid while $\overline{\text{CAS}}$ is low; $\overline{\text{CAS}}$ going high returns it to a high-impedance state. In a read-modify-write cycle, the output will follow the sequence for the read cycle.

refresh

A refresh operation must be performed at least once every four milliseconds to retain data. This can be achieved by strobing each of the 256 rows (A0-A7). A normal read or write cycle will refresh all bits in each row that is selected. A $\overline{\text{RAS}}$ -only operation can be used by holding $\overline{\text{CAS}}$ at the high (inactive) level, thus conserving power as the output buffer remains in the high-impedance state.

CAS-before-RAS refresh

The CAS-before-RAS refresh is utilized by bringing $\overline{\text{CAS}}$ low earlier than $\overline{\text{RAS}}$ (see parameter t_{CLRL}) and holding it low after $\overline{\text{RAS}}$ falls (see parameter t_{RLCHR}). For successive CAS-before-RAS refresh cycles, $\overline{\text{CAS}}$ can remain low while cycling $\overline{\text{RAS}}$. The external address is ignored and the refresh address is generated internally.

hidden refresh

Hidden refresh may be performed while maintaining valid data at the output pin. This is accomplished by holding $\overline{\text{CAS}}$ at V_{IL} after a read operation and cycling $\overline{\text{RAS}}$ after a specified precharge period, similar to a "RAS-only" refresh cycle. The external address is also ignored during the hidden refresh cycles.

page mode

Page-mode operation allows effectively faster memory access by keeping the same row address and strobing random column addresses onto the chip. Thus, the time required to set up and strobe sequential row addresses for the same page is eliminated. The maximum number of columns that can be addressed is determined by $t_{\text{w}}(\text{RL})$, the maximum $\overline{\text{RAS}}$ low pulse duration.

power-up

To achieve proper device operation, an initial pause of 200 μs is required after power up followed by a minimum of eight initialization cycles.

logic symbol†

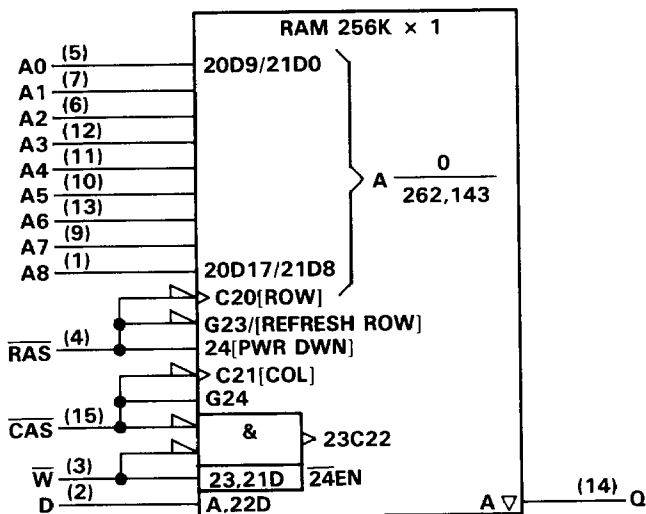

† This symbol is in accordance with ANSI/IEEE Std 91-1984 and IEC Publication 617-12. Pin numbers shown are for the JD package.

SMJ4256 262,144-BIT DYNAMIC RANDOM-ACCESS MEMORY

functional block diagram

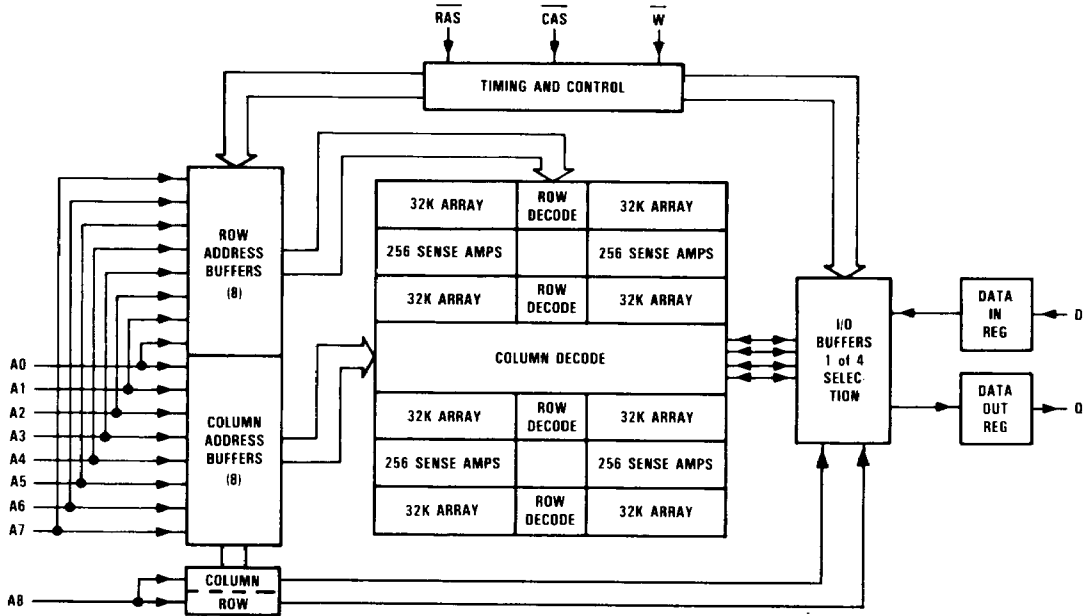

absolute maximum ratings over operating temperature range (unless otherwise noted)†

Voltage range for any pin, including V _{DD} supply (see Note 1)	-1 V to 7 V
Short circuit output current	50 mA
Power dissipation	1 W
Minimum operating free-air temperature	-55°C
Operating case temperature	110°C
Storage temperature range	-65°C to 150°C

†Stresses beyond those listed under "Absolute Maximum Ratings" may cause permanent damage to the device. This is a stress rating only, and functional operation of the device at these or any other conditions beyond those indicated in the "Recommended Operating Conditions" section of this specification is not implied. Exposure to absolute-maximum-rated conditions for extended periods may affect device reliability.

NOTE 1: All voltage values in this data sheet are with respect to V_{SS}.

recommended operating conditions

		MIN	NOM	MAX	UNIT
V _{DD}	Supply voltage	4.75	5	5.25	V
V _{SS}	Supply voltage		0		V
V _{IH}	High-level input voltage	2.4		5	V
V _{IL}	Low-level input voltage (see Note 2)	-0.5		0.8	V
T _A	Operating free-air temperature	-55			°C
T _C	Operating case temperature			110	°C

NOTE 2: The algebraic convention, where the more negative (less positive) limit is designated as maximum, is used in this data sheet for logic voltage levels only.

SMJ4256

262,144-BIT DYNAMIC RANDOM-ACCESS MEMORY

electrical characteristics over full ranges of recommended operating conditions (unless otherwise noted)

PARAMETER	TEST CONDITIONS	SMJ4256-12			UNIT
		MIN	TYP†	MAX	
V _{OH}	High-level output voltage	I _{OH} = -5 mA			V
V _{OL}	Low-level output voltage	I _{OL} = 4.2 mA			V
I _I	Input current (leakage)	V _I = 0 V to 5 V, V _{DD} = 5.25 V, Output open			± 10 μA
I _O	Output current (leakage)	V _O = 0 V to 5.5 V, V _{DD} = 5.25 V, $\overline{\text{CAS}}$ high			± 10 μA
I _{DD1}	Average operating current during read or write cycle	t _c = minimum cycle, Output open			60 80 mA
I _{DD2}	Standby current	After 1 memory cycle, $\overline{\text{RAS}}$ and $\overline{\text{CAS}}$ high, Output open			2.5 5 mA
I _{DD3}	Average refresh current	t _c = minimum cycle, $\overline{\text{RAS}}$ cycling, $\overline{\text{CAS}}$ high, Output open			45 63 mA
I _{DD4}	Average page-mode current	t _{c(P)} = minimum cycle, $\overline{\text{RAS}}$ low, $\overline{\text{CAS}}$ cycling, Output open			35 50 mA

PARAMETER	TEST CONDITIONS	SMJ4256-15			SMJ4256-20			UNIT	
		MIN	TYP†	MAX	MIN	TYP†	MAX		
V _{OH}	High-level output voltage	I _{OH} = -5 mA			2.4			V	
V _{OL}	Low-level output voltage	I _{OL} = 4.2 mA			0.4			V	
I _I	Input current (leakage)	V _I = 0 V to 5 V, V _{DD} = 5.25 V, Output open			± 10			± 10 μA	
I _O	Output current (leakage)	V _O = 0 V to 5.5 V, V _{DD} = 5.25 V, $\overline{\text{CAS}}$ high			± 10			± 10 μA	
I _{DD1}	Average operating current during read or write cycle	t _c = minimum cycle, Output open			60	75	45	60	mA
I _{DD2}	Standby current	After 1 memory cycle, $\overline{\text{RAS}}$ and $\overline{\text{CAS}}$ high, Output open			2.5	5	2.5	5	mA
I _{DD3}	Average refresh current	t _c = minimum cycle, $\overline{\text{RAS}}$ cycling, $\overline{\text{CAS}}$ high, Output open			45	60	35	45	mA
I _{DD4}	Average page-mode current	t _{c(P)} = minimum cycle, $\overline{\text{RAS}}$ low, $\overline{\text{CAS}}$ cycling, Output open			35	50	25	45	mA

†All typical values are at T_A = 25°C and nominal supply voltages.

SMJ4256
262,144-BIT DYNAMIC RANDOM-ACCESS MEMORY

capacitance over recommended supply voltage range and operating temperature range, $f = 1 \text{ MHz}^\ddagger$

PARAMETER		MIN	TYP [†]	MAX	UNIT
$C_{i(A)}$	Input capacitance, address inputs		4	6	pF
$C_{i(D)}$	Input capacitance, data input		4	7	pF
$C_{i(RC)}$	Input capacitance, strobe inputs		4	7	pF
$C_{i(W)}$	Input capacitance, write enable input		4	7	pF
C_o	Output capacitance		5	7	pF

[†]All typical values are at $T_A = 25^\circ\text{C}$ and nominal supply voltages.

[‡] V_{CC} equal to 5.0 V and the bias on pins under test is 0.0 V

switching characteristics over recommended supply voltage range and operating temperature range

PARAMETER	TEST CONDITIONS [§]	ALT. SYMBOL	SMJ4256-12		UNIT
			MIN	MAX	
$t_{a(C)}$	Access time from \overline{CAS}	$t_{RLCL} \geq \text{MAX}$, $C_L = 80 \text{ pF}$, $I_{OH} = 5 \text{ mA}$, $I_{OL} = 4.2 \text{ mA}$		65	ns
$t_{a(R)}$	Access time from \overline{RAS}	$t_{RLCL} = \text{MAX}$, $C_L = 80 \text{ pF}$, $I_{OH} = -5 \text{ mA}$, $I_{OL} = 4.2 \text{ mA}$		120	ns
$t_{dis(CH)}$	Output disable time after \overline{CAS} high	$C_L = 80 \text{ pF}$, $I_{OH} = -5 \text{ mA}$, $I_{OL} = 4.2 \text{ mA}$	t_{OFF}	0 30	ns

PARAMETER	TEST CONDITIONS [§]	ALT. SYMBOL	SMJ4256-15		SMJ4256-20		UNIT
			MIN	MAX	MIN	MAX	
$t_{a(C)}$	Access time from \overline{CAS}	$t_{RLCL} \geq \text{MAX}$, $C_L = 80 \text{ pF}$, $I_{OH} = -5 \text{ mA}$, $I_{OL} = 4.2 \text{ mA}$		80		100	ns
$t_{a(R)}$	Access time from \overline{RAS}	$t_{RLCL} = \text{MAX}$, $C_L = 80 \text{ pF}$, $I_{OH} = -5 \text{ mA}$, $I_{OL} = 4.2 \text{ mA}$		150		200	ns
$t_{dis(CH)}$	Output disable time after \overline{CAS} high	$C_L = 80 \text{ pF}$, $I_{OH} = -5 \text{ mA}$, $I_{OL} = 4.2 \text{ mA}$	t_{OFF}	0 30	0 35		ns

[§] Figure 1 shows the load circuit; C_L values shown are typical for test system used.

timing requirements over recommended supply voltage range and operating temperature range

	ALT. SYMBOL	SMJ4256-12		UNIT
		MIN	MAX	
$t_{c(P)}$ Page-mode cycle time (read or write cycle)†	t_{PC}	125		ns
$t_{c(PM)}$ Page-mode cycle time (read-modify-write cycle)†	t_{PCM}	172		ns
$t_{c(rd)}$ Read cycle time†	t_{RC}	230		ns
$t_{c(W)}$ Write cycle time†	t_{WC}	230		ns
$t_{c(rdW)}$ Read-write/read-modify-write cycle time†	t_{RWC}	277		ns
$t_{w(CH)P}$ Pulse duration, \overline{CAS} high (page mode)	t_{CP}	50		ns
$t_{w(CH)}$ Pulse duration, \overline{CAS} high (non-page mode)	t_{CPN}	25		ns
$t_{w(CL)}$ Pulse duration, \overline{CAS} low‡	t_{CAS}	65	10,000	ns
$t_{w(RH)P}$ Pulse duration, \overline{RAS} high (page mode)	t_{RP}	115		ns
$t_{w(RH)}$ Pulse duration, \overline{RAS} high (non-page mode)	t_{RPN}	100		ns
$t_{w(RL)}$ Pulse duration, \overline{RAS} low§	t_{RAS}	120	10,000	ns
$t_{w(W)}$ Write pulse duration	t_{WP}	40		ns
$t_{su(CA)}$ Column-address setup time	t_{ASC}	0		ns
$t_{su(RA)}$ Row-address setup time	t_{ASR}	0		ns
$t_{su(D)}$ Data setup time	t_{DS}	3		ns
$t_{su(rd)}$ Read-command setup time	t_{RCS}	5		ns
$t_{su(WCL)}$ Early write-command setup time before \overline{CAS} low	t_{WCS}	0		ns
$t_{su(WCH)}$ Write-command setup time before \overline{CAS} high	t_{CWL}	40		ns
$t_{su(WRH)}$ Write-command setup time before \overline{RAS} high	t_{RWL}	40		ns
$t_h(CLCA)$ Column-address hold time after \overline{CAS} low	t_{CAH}	20		ns
$t_h(RA)$ Row-address hold time	t_{RAH}	15		ns
$t_h(RLCA)$ Column-address hold time after \overline{RAS} low	t_{AR}	75		ns
$t_h(CLD)$ Data hold time after \overline{CAS} low	t_{DH}	40		ns
$t_h(RLD)$ Data hold time after \overline{RAS} low	t_{DHR}	95		ns
$t_h(WLD)$ Data hold time after \overline{W} low	t_{DH}	40		ns
$t_h(CHrd)$ Read-command hold time after \overline{CAS} high	t_{RCH}	0		ns
$t_h(RHrd)$ Read-command hold time after \overline{RAS} high	t_{RRH}	10		ns
$t_h(CLW)$ Write-command hold time after \overline{CAS} low	t_{WCH}	40		ns
$t_h(RLW)$ Write-command hold time after \overline{RAS} low	t_{WCR}	95		ns

Continued next page.

NOTES: 3. Timing measurements are referenced to V_{IL} max and V_{IH} min.

4. System transition times (rise and fall) for \overline{RAS} and \overline{CAS} are to be a minimum of 3 ns and a maximum of 50 ns.

†All cycle times assume $t_t = 5$ ns.

‡In a read-modify-write cycle, t_{CLWL} and $t_{su(WCH)}$ must be observed. Depending on the user's transition times, this may require additional \overline{CAS} low time ($t_{w(CL)}$). This applies to page-mode read-modify-write also.

§In a read-modify-write cycle, t_{RLWL} and $t_{su(WRH)}$ must be observed. Depending on the user's transition times, this may require additional \overline{RAS} low time ($t_{w(RL)}$).

SMJ4256
262,144-BIT DYNAMIC RANDOM-ACCESS MEMORY

timing requirements over recommended supply voltage range and operating temperature range
 (continued)

	ALT. SYMBOL	SMJ4256-12		UNIT
		MIN	MAX	
t_{RLCH} Delay time, \overline{RAS} low to \overline{CAS} high	t_{CSH}	120		ns
t_{CHRL} Delay time, \overline{CAS} high to \overline{RAS} low	t_{CRP}	5		ns
t_{CLRH} Delay time, \overline{CAS} low to \overline{RAS} high	t_{RSH}	65		ns
t_{RHCL} Delay time, \overline{RAS} high to \overline{CAS} low [†]	t_{RCP}	25		ns
t_{RLCHR} Delay time, \overline{RAS} low to \overline{CAS} high [†]	t_{CHR}	30		ns
t_{CLRL} Delay time, \overline{CAS} low to \overline{RAS} low [†]	t_{CSR}	30		ns
t_{CLWL} Delay time, \overline{CAS} low to \overline{W} low (read-modify-write cycle only)	t_{CWD}	67		ns
t_{RLCL} Delay time, \overline{RAS} low to \overline{CAS} low (maximum value specified only to guarantee access time)	t_{RCD}	25	55	ns
t_{RLWL} Delay time, \overline{RAS} low to \overline{W} low (read-modify-write cycle only)	t_{RWD}	122		ns
t_{rf} Refresh time interval	t_{REF}		4	ms

Continued next page.

NOTE 3: Timing requirements are referenced to V_{IL} max and V_{IH} min.

[†] \overline{CAS} -before- \overline{RAS} refresh only.

timing requirements over recommended supply voltage range and operating temperature range
(continued)

	ALT. SYMBOL	SMJ4256-15		SMJ4256-20		UNIT
		MIN	MAX	MIN	MAX	
$t_{c(P)}$ Page-mode cycle time (read or write cycle) [†]	t_{PC}	145		190		ns
$t_{c(PM)}$ Page-mode cycle time (read-modify-write cycle) [†]	t_{PCM}	205		250		ns
$t_{c(rd)}$ Read cycle time [†]	t_{RC}	260		330		ns
$t_{c(W)}$ Write cycle time [†]	t_{WC}	260		330		ns
$t_{c(rdW)}$ Read-write/read-modify-write cycle time [†]	t_{RWC}	315		390		ns
$t_w(CH)P$ Pulse duration, \overline{CAS} high (page mode)	t_{CP}	60		80		ns
$t_w(CH)$ Pulse duration, \overline{CAS} high (non-page mode)	t_{CPN}	30		40		ns
$t_w(CL)$ Pulse duration, \overline{CAS} low [†]	t_{CAS}	80	10,000	100	10,000	ns
$t_w(RH)P$ Pulse duration, \overline{RAS} high (page mode)	t_{RP}	120		120		ns
$t_w(RH)$ Pulse duration, \overline{RAS} high (non-page mode)	t_{RPN}	100		120		ns
$t_w(RL)$ Pulse duration, \overline{RAS} low [§]	t_{RAS}	150	10,000	200	10,000	ns
$t_w(W)$ Write pulse duration	t_{WP}	45		55		ns
$t_{su(CA)}$ Column-address setup time	t_{ASC}	0		0		ns
$t_{su(RA)}$ Row-address setup time	t_{ASR}	0		0		ns
$t_{su(D)}$ Data setup time	t_{DS}	3		3		ns
$t_{su(rd)}$ Read-command setup time	t_{RCS}	5		5		ns
$t_{su(WCL)}$ Early write-command setup time before \overline{CAS} low	t_{WCS}	0		0		ns
$t_{su(WCH)}$ Write-command setup time before \overline{CAS} high	t_{CWL}	45		65		ns
$t_{su(WRH)}$ Write-command setup time before \overline{RAS} high	t_{RWL}	45		65		ns
$t_h(CLCA)$ Column-address hold time after \overline{CAS} low	t_{CAH}	30		45		ns
$t_h(RA)$ Row-address hold time	t_{RAH}	20		25		ns
$t_h(RLCA)$ Column-address hold time after \overline{RAS} low	t_{AR}	100		145		ns
$t_h(CLD)$ Data hold time after \overline{CAS} low	t_{DH}	50		55		ns
$t_h(RLD)$ Data hold time after \overline{RAS} low	t_{DHR}	120		155		ns
$t_h(WLD)$ Data hold time after \overline{W} low	t_{DH}	45		55		ns
$t_h(CHrd)$ Read-command hold time after \overline{CAS} high	t_{RCH}	0		0		ns
$t_h(RHrd)$ Read-command hold time after \overline{RAS} high	t_{RRH}	10		15		ns
$t_h(CLW)$ Write-command hold time after \overline{CAS} low	t_{WCH}	50		55		ns
$t_h(RLW)$ Write-command hold time after \overline{RAS} low	t_{WCR}	120		155		ns

Continued next page.

NOTES: 3. Timing measurements are referenced to V_{IL} max and V_{IH} min.

4. System transition times (rise and fall) for \overline{RAS} and \overline{CAS} are to be a minimum of 3 ns and a maximum of 50 ns.

[†]All cycle times assume $t_t = 5$ ns.

[‡]In a read-modify-write cycle, t_{CLWL} and $t_{su(WCH)}$ must be observed. Depending on the user's transition times, this may require additional \overline{CAS} low time ($t_w(CL)$). This applies to page-mode read-modify-write also.

[§]In a read-modify-write cycle, t_{RLWL} and $t_{su(WRH)}$ must be observed. Depending on the user's transition times, this may require additional \overline{RAS} low time ($t_w(RL)$).

SMJ4256
262,144-BIT DYNAMIC RANDOM-ACCESS MEMORY

timing requirements over recommended supply voltage range and operating temperature range (concluded)

	ALT. SYMBOL	SMJ4256-15		SMJ4256-20		UNIT
		MIN	MAX	MIN	MAX	
t_{RLCH} Delay time, \overline{RAS} low to \overline{CAS} high	t_{CSH}	150		200		ns
t_{CHRL} Delay time, \overline{CAS} high to \overline{RAS} low	t_{CRP}	5		5		ns
$t_{CLR H}$ Delay time, \overline{CAS} low to \overline{RAS} high	t_{RSH}	80		100		ns
t_{RHCL} Delay time, \overline{RAS} high to \overline{CAS} low [†]	t_{RCP}	25		25		ns
t_{RLCHR} Delay time, \overline{RAS} low to \overline{CAS} high [†]	t_{CHR}	30		40		ns
t_{CLRL} Delay time, \overline{CAS} low to \overline{RAS} low [†]	t_{CSR}	30		35		ns
t_{CLWL} Delay time, \overline{CAS} low to \overline{W} low (read-modify-write cycle only)	t_{CWD}	85		90		ns
t_{RLCL} Delay time, \overline{RAS} low to \overline{CAS} low (maximum value specified only to guarantee access time)	t_{RCD}	25	70	35	100	ns
t_{RLWL} Delay time, \overline{RAS} low to \overline{W} low (read-modify-write cycle only)	t_{RWD}	155		190		ns
t_{rf} Refresh time interval	t_{REF}		4		4	ms

NOTE 3: Timing measurements are referenced to V_{IL} max and V_{IH} min.
[†] \overline{CAS} -before- \overline{RAS} refresh only.

PARAMETER MEASUREMENT INFORMATION

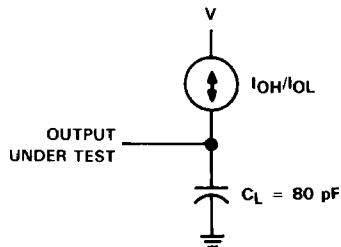
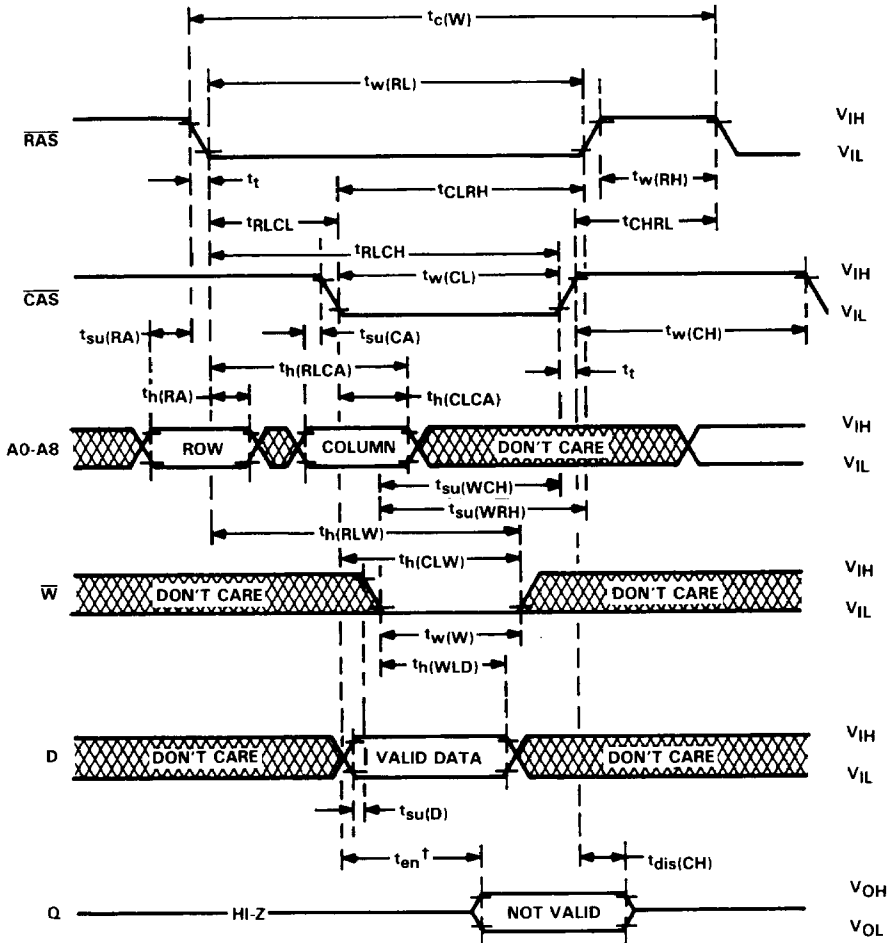

FIGURE 1. EQUIVALENT LOAD CIRCUIT

write cycle timing



†The enable time (t_{en}) for a write cycle is equal in duration to the access time from \overline{CAS} ($t_{a(C)}$) in a read cycle, but the active levels at the output are invalid.

SMJ4256
262,144-BIT DYNAMIC RANDOM-ACCESS MEMORY

read-write/read-modify-write cycle timing

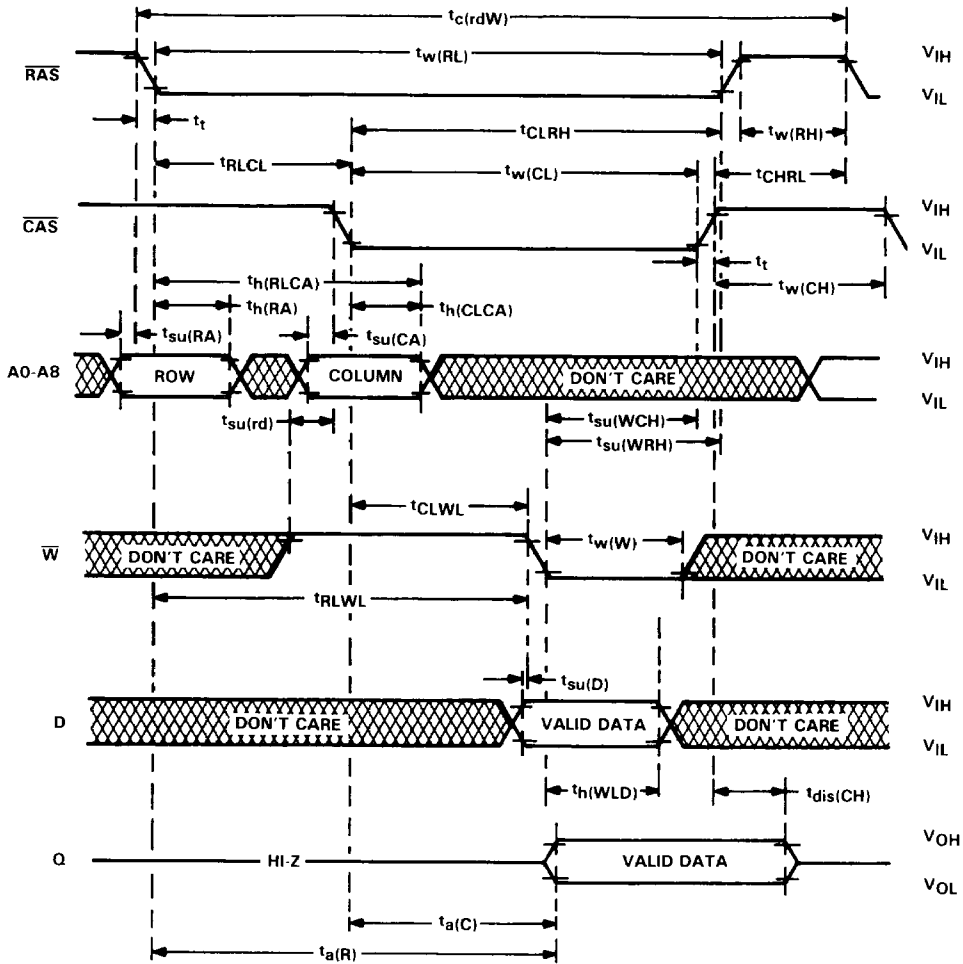

page-mode read-modify-write cycle timing

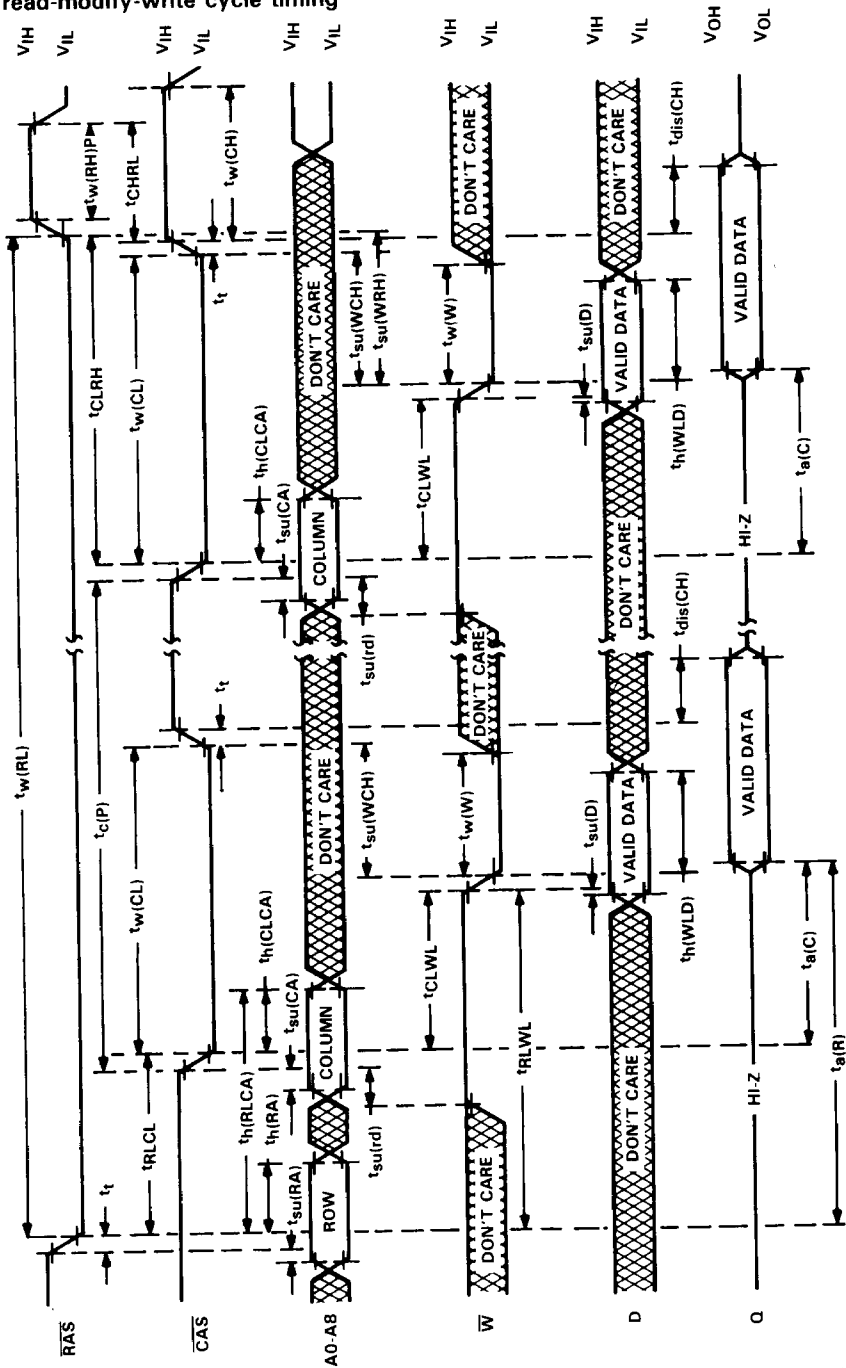

NOTE 7: A read or a write cycle can be intermixed with read-modify-write cycles as long as the read and write timing specifications are not violated.



SMJ4256
262,144-BIT DYNAMIC RANDOM-ACCESS MEMORY

RAS-only refresh cycle timing

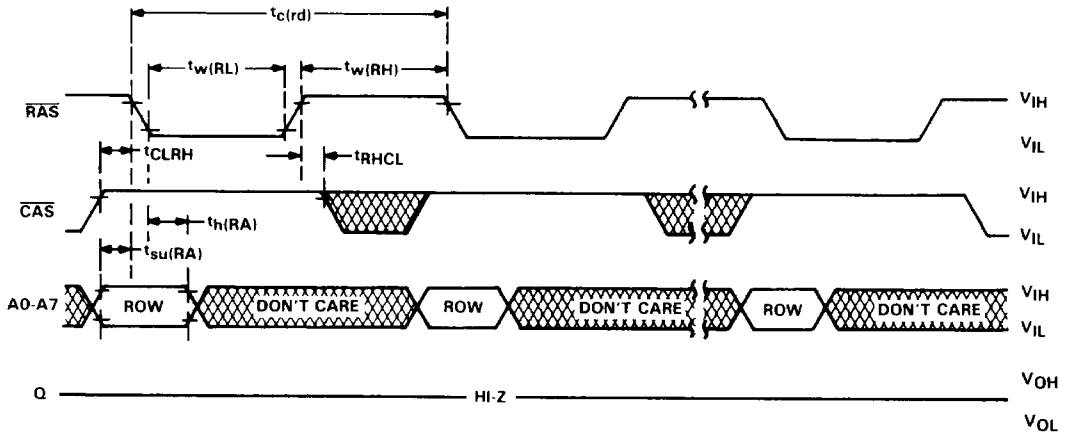

hidden refresh cycle timing

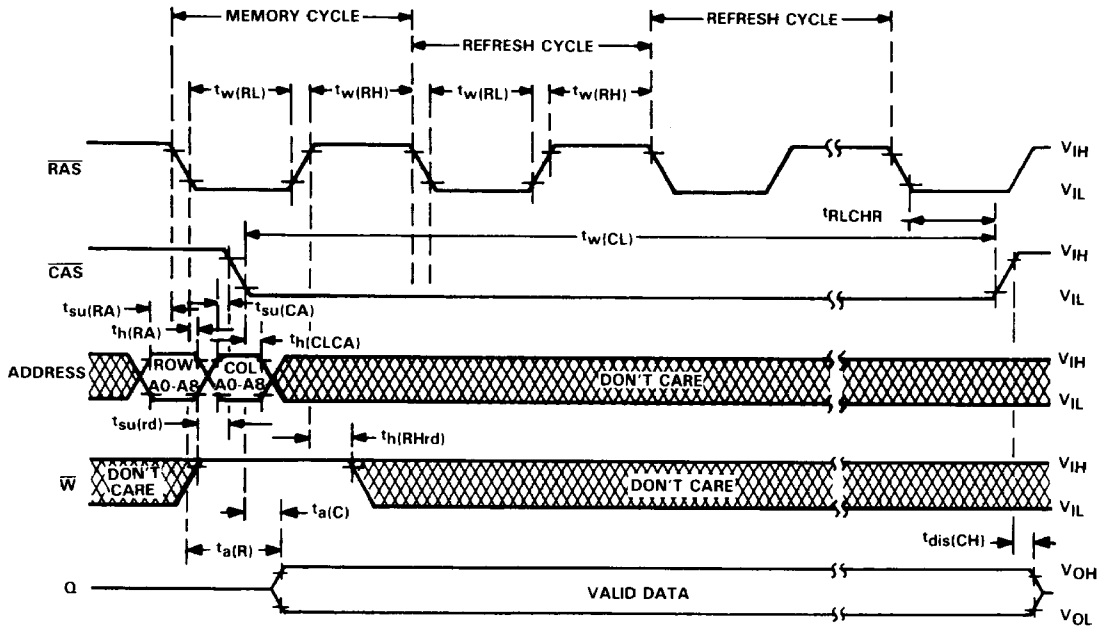

automatic ($\overline{\text{CAS}}$ -before- $\overline{\text{RAS}}$) refresh cycle timing

