

Rochester Electronics Manufactured Components

Rochester branded components are manufactured using either die/wafers purchased from the original suppliers or Rochester wafers recreated from the original IP. All recreations are done with the approval of the OCM.

Parts are tested using original factory test programs or Rochester developed test solutions to guarantee product meets or exceed the OCM data sheet.

Quality Overview

- ISO-9001
- AS9120 certification
- Qualified Manufacturers List (QML) MIL-PRF-35835
 - Class Q Military
 - Class V Space Level
- Qualified Suppliers List of Distributors (QSLD)
 - Rochester is a critical supplier to DLA and meets all industry and DLA standards.

Rochester Electronics, LLC is committed to supplying products that satisfy customer expectations for quality and are equal to those originally supplied by industry manufacturers.

The original manufacturer's datasheet accompanying this document reflects the performance and specifications of the Rochester manufactured version of this device. Rochester Electronics guarantees the performance of its semiconductor products to the original OEM specifications. 'Typical' values are for reference purposes only. Certain minimum or maximum ratings may be based on product characterization, design, simulation, or sample testing.

SN74LS165

8-Bit Parallel-to-Serial Shift Register

The SN74LS165 is an 8-bit parallel load or serial-in register with complementary outputs available from the last stage. Parallel inputting occurs asynchronously when the Parallel Load (\overline{PL}) input is LOW. With \overline{PL} HIGH, serial shifting occurs on the rising edge of the clock; new data enters via the Serial Data (DS) input. The 2-input OR clock can be used to combine two independent clock sources, or one input can act as an active LOW clock enable.

GUARANTEED OPERATING RANGES

Symbol	Parameter	Min	Typ	Max	Unit
V _{CC}	Supply Voltage	4.75	5.0	5.25	V
T _A	Operating Ambient Temperature Range	0	25	70	°C
I _{OH}	Output Current – High			-0.4	mA
I _{OL}	Output Current – Low			8.0	mA



ON Semiconductor™

<http://onsemi.com>

LOW POWER SCHOTTKY

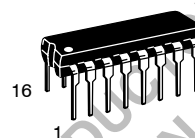

PLASTIC
N SUFFIX
CASE 648

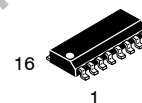

SOIC
D SUFFIX
CASE 751B

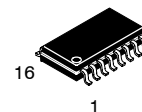

SOEIAJ
M SUFFIX
CASE 966

ORDERING INFORMATION

Device	Package	Shipping
SN74LS165N	16 Pin DIP	2000 Units/Box
SN74LS165D	SOIC-16	38 Units/Rail
SN74LS165DR2	SOIC-16	2500/Tape & Reel
SN74LS165M	SOEIAJ-16	See Note 1
SN74LS165MEL	SOEIAJ-16	See Note 1

1. For ordering information on the EIAJ version of the SOIC package, please contact your local ON Semiconductor representative.

SN74LS165

CONNECTION DIAGRAM DIP (TOP VIEW)

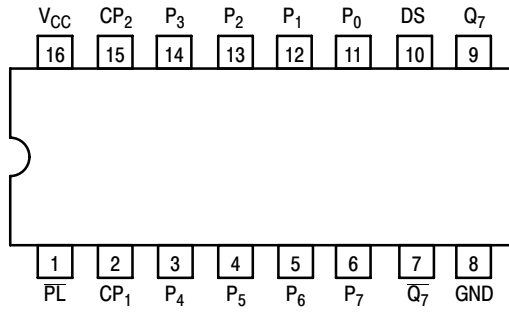

NOTE:
The Flatpak version has the same pinouts (Connection Diagram) as the Dual In-Line Package.

PIN NAMES

CP ₁ , CP ₂	Clock (LOW-to-HIGH Going Edge) Inputs
DS	Serial Data Input
PL	Asynchronous Parallel Load (Active LOW) Input
P ₀ - P ₇	Parallel Data Inputs
Q ₇	Serial Output from Last State
Q̄ ₇	Complementary Output

LOADING (Note a)

	HIGH	LOW
CP ₁ , CP ₂	0.5 U.L.	0.25 U.L.
DS	0.5 U.L.	0.25 U.L.
PL	1.5 U.L.	0.75 U.L.
P ₀ - P ₇	0.5 U.L.	0.25 U.L.
Q ₇	10 U.L.	5 U.L.
Q̄ ₇	10 U.L.	5 U.L.

NOTES:

a) 1 TTL Unit Load (U.L.) = 40 μA HIGH/1.6 mA LOW.

LOGIC SYMBOL

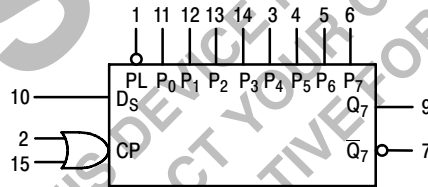

V_{CC} = PIN 16
GND = PIN 8

SN74LS165

LOGIC DIAGRAM

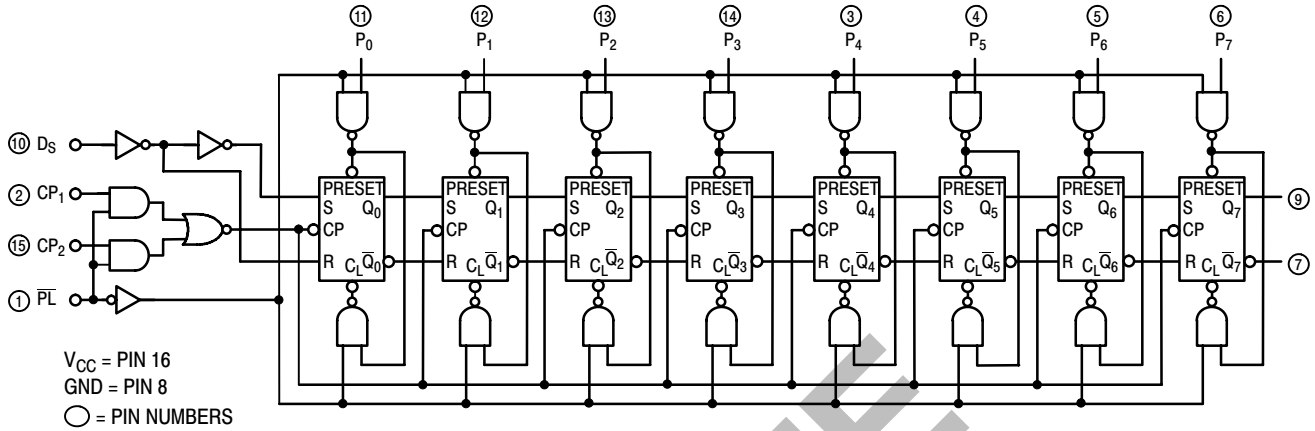

FUNCTIONAL DESCRIPTION

The SN74LS165 contains eight clocked master/slave RS flip-flops connected as a shift register, with auxiliary gating to provide overriding asynchronous parallel entry. Parallel data enters when the \overline{PL} signal is LOW. The parallel data can change while \overline{PL} is LOW, provided that the recommended setup and hold times are observed.

For clock operation, \overline{PL} must be HIGH. The two clock inputs perform identically; one can be used as a clock inhibit

by applying a HIGH signal. To avoid double clocking, however, the inhibit signal should only go HIGH while the clock is HIGH. Otherwise, the rising inhibit signal will cause the same response as a rising clock edge. The flip-flops are edge-triggered for serial operations. The serial input data can change at any time, provided only that the recommended setup and hold times are observed, with respect to the rising edge of the clock.

TRUTH TABLE

\overline{PL}	CP		CONTENTS								RESPONSE
	1	2	Q_0	Q_1	Q_2	Q_3	Q_4	Q_5	Q_6	Q_7	
L	X	X	P_0	P_1	P_2	P_3	P_4	P_5	P_6	P_7	Parallel Entry
H	L	\nearrow	D_S	Q_0	Q_1	Q_2	Q_3	Q_4	Q_5	Q_6	Right Shift
H	H	\searrow	Q_0	Q_1	Q_2	Q_3	Q_4	Q_5	Q_6	Q_7	No Change
H	\searrow	L	D_S	Q_0	Q_1	Q_2	Q_3	Q_4	Q_5	Q_6	Right Shift
H	\searrow	H	Q_0	Q_1	Q_2	Q_3	Q_4	Q_5	Q_6	Q_7	No Change

H = HIGH Voltage Level
 L = LOW Voltage Level
 X = Immaterial

SN74LS165

DC CHARACTERISTICS OVER OPERATING TEMPERATURE RANGE (unless otherwise specified)

Symbol	Parameter	Limits			Unit	Test Conditions
		Min	Typ	Max		
V _{IH}	Input HIGH Voltage	2.0			V	Guaranteed Input HIGH Voltage for All Inputs
V _{IL}	Input LOW Voltage			0.8	V	Guaranteed Input LOW Voltage for All Inputs
V _{IK}	Input Clamp Diode Voltage		-0.65	-1.5	V	V _{CC} = MIN, I _{IN} = -18 mA
V _{OH}	Output HIGH Voltage	2.7	3.5		V	V _{CC} = MIN, I _{OH} = MAX, V _{IN} = V _{IH} or V _{IL} per Truth Table
V _{OL}	Output LOW Voltage		0.25	0.4	V	I _{OL} = 4.0 mA
			0.35	0.5	V	I _{OL} = 8.0 mA
I _{IH}	Input HIGH Current Other Inputs PL Input			20 60	μA	V _{CC} = MAX, V _{IN} = 2.7 V
	Other Inputs PL Input			0.1 0.3	mA	V _{CC} = MAX, V _{IN} = 7.0 V
I _{IL}	Input LOW Current Other Inputs PL Input			-0.4 -1.2	mA	V _{CC} = MAX, V _{IN} = 0.4 V
I _{OS}	Short Circuit Current (Note 2)	-20		-100	mA	V _{CC} = MAX
I _{CC}	Power Supply Current			36	mA	V _{CC} = MAX

2. Not more than one output should be shorted at a time, nor for more than 1 second.

AC CHARACTERISTICS (T_A = 25°C)

Symbol	Parameter	Limits			Unit	Test Conditions
		Min	Typ	Max		
f _{MAX}	Maximum Input Clock Frequency	25	35		MHz	V _{CC} = 5.0 V C _L = 15 pF
t _{PLH} t _{PHL}	Propagation Delay PL to Output		22 22	35 35	ns	
t _{PLH} t _{PHL}	Propagation Delay Clock to Output		27 28	40 40	ns	
t _{PLH} t _{PHL}	Propagation Delay P ₇ to Q ₇		14 21	25 30	ns	
t _{PLH} t _{PHL}	Propagation Delay P ₇ to Q ₇		21 16	30 25	ns	

AC SETUP REQUIREMENTS (T_A = 25°C)

Symbol	Parameter	Limits			Unit	Test Conditions
		Min	Typ	Max		
t _W	CP Clock Pulse Width	25			ns	V _{CC} = 5.0 V
t _W	PL Pulse Width	15			ns	
t _s	Parallel Data Setup Time	10			ns	
t _s	Serial Data Setup Time	20			ns	
t _s	CP ₁ to CP ₂ Setup Time ¹	30			ns	
t _h	Hold Time	0			ns	
t _{rec}	Recovery Time, PL to CP	45			ns	

¹The role of CP₁ and CP₂ in an application may be interchanged.

DEFINITION OF TERMS:

SETUP TIME (t_s) — is defined as the minimum time required for the correct logic level to be present at the logic input prior to the clock transition from LOW-to-HIGH in order to be recognized and transferred to the outputs.

HOLD TIME (t_h) — is defined as the minimum time following the clock transition from LOW-to-HIGH that the logic level must be maintained at the input in order to ensure

continued recognition. A negative hold time indicates that the correct logic level may be released prior to the clock transition from LOW-to-HIGH and still be recognized.

RECOVERY TIME (t_{rec}) — is defined as the minimum time required between the end of the \overline{PL} pulse and the clock transition from LOW-to-HIGH in order to recognize and transfer loaded Data to the Q outputs.

AC WAVEFORMS

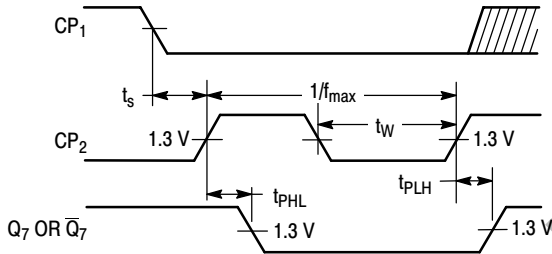

Figure 1.

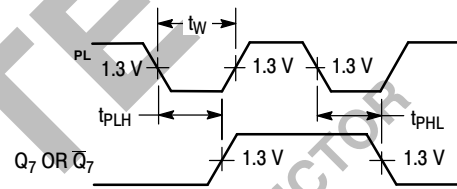

Figure 2.

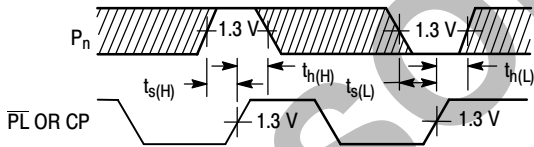

Figure 3.

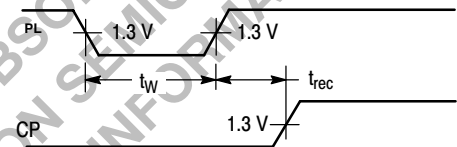

Figure 4.

OBSOLETE
THIS DEVICE IS OBSOLETE
PLEASE CONTACT YOUR ON SEMICONDUCTOR
REPRESENTATIVE FOR INFORMATION

SN74LS165

PACKAGE DIMENSIONS

N SUFFIX
 PLASTIC PACKAGE
 CASE 648-08
 ISSUE R

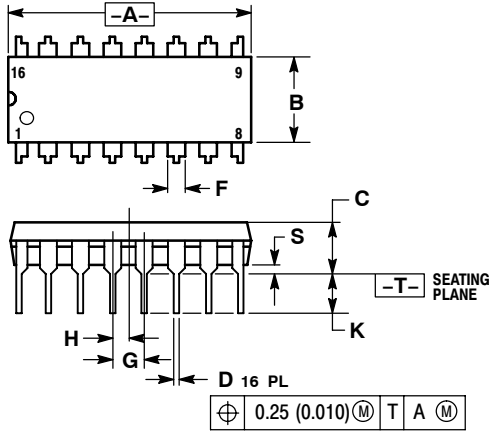

NOTES:

1. DIMENSIONING AND TOLERANCING PER ANSI Y14.5M, 1982.
2. CONTROLLING DIMENSION: INCH.
3. DIMENSION L TO CENTER OF LEADS WHEN FORMED PARALLEL.
4. DIMENSION B DOES NOT INCLUDE MOLD FLASH.
5. ROUNDED CORNERS OPTIONAL.

DIM	INCHES		MILLIMETERS	
	MIN	MAX	MIN	MAX
A	0.740	0.770	18.80	19.55
B	0.250	0.270	6.35	6.85
C	0.145	0.175	3.69	4.44
D	0.015	0.021	0.39	0.53
F	0.040	0.70	1.02	1.77
G	0.100 BSC		2.54 BSC	
H	0.050 BSC		1.27 BSC	
J	0.008	0.015	0.21	0.38
K	0.110	0.130	2.80	3.30
L	0.295	0.305	7.50	7.74
M	0° 10°		0° 10°	
S	0.020	0.040	0.51	1.01

OBSOLETE

THIS DEVICE IS OBSOLETE
 PLEASE CONTACT YOUR ON SEMICONDUCTOR
 REPRESENTATIVE FOR INFORMATION

SN74LS165

PACKAGE DIMENSIONS

D SUFFIX PLASTIC SOIC PACKAGE CASE 751B-05 ISSUE J

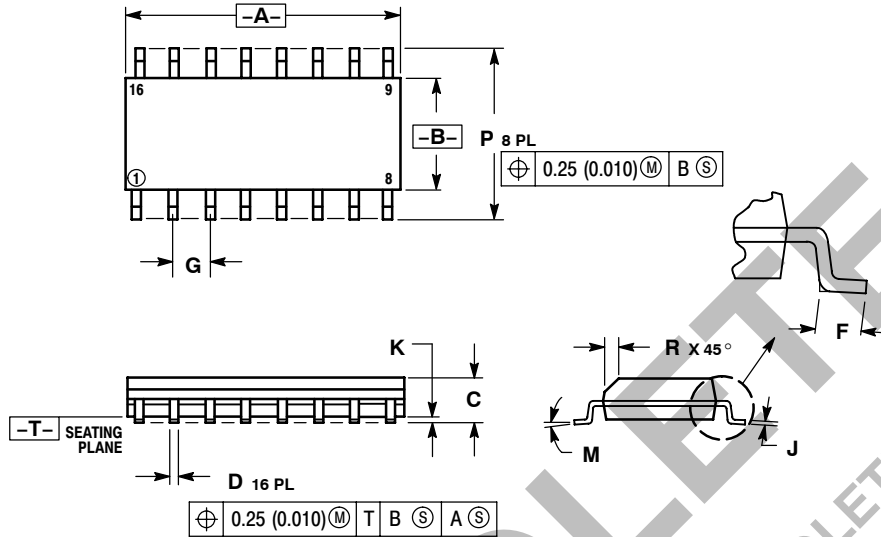

NOTES:

1. DIMENSIONING AND TOLERANCING PER ANSI Y14.5M, 1982.
2. CONTROLLING DIMENSION: MILLIMETER.
3. DIMENSIONS A AND B DO NOT INCLUDE MOLD PROTRUSION.
4. MAXIMUM MOLD PROTRUSION 0.15 (0.006) PER SIDE.
5. DIMENSION D DOES NOT INCLUDE DAMBAR PROTRUSION. ALLOWABLE DAMBAR PROTRUSION SHALL BE 0.127 (0.005) TOTAL IN EXCESS OF THE D DIMENSION AT MAXIMUM MATERIAL CONDITION.

DIM	MILLIMETERS		INCHES	
	MIN	MAX	MIN	MAX
A	9.80	10.00	0.386	0.393
B	3.80	4.00	0.150	0.157
C	1.35	1.75	0.054	0.068
D	0.35	0.49	0.014	0.019
F	0.40	1.25	0.016	0.049
G	1.27 BSC		0.050 BSC	
J	0.19	0.25	0.008	0.009
K	0.10	0.25	0.004	0.009
M	0°		7°	
P	5.80	6.20	0.229	0.244
R	0.25	0.50	0.010	0.019

OBSOLETE

THIS DEVICE IS OBSOLETE
PLEASE CONTACT YOUR ON SEMICONDUCTOR
REPRESENTATIVE FOR INFORMATION

SN74LS165

PACKAGE DIMENSIONS

M SUFFIX
SOEIAJ PACKAGE
CASE 966-01
ISSUE O

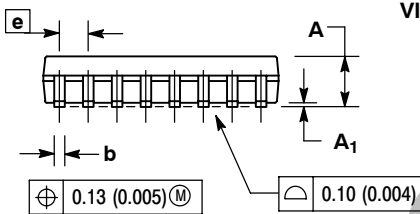
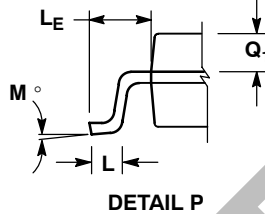
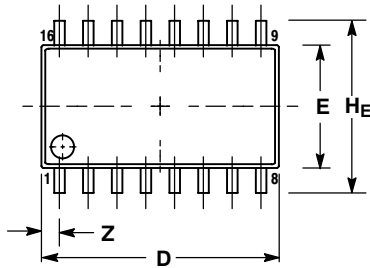

NOTES:

1. DIMENSIONING AND TOLERANCING PER ANSI Y14.5M, 1982.
2. CONTROLLING DIMENSION: MILLIMETER.
3. DIMENSIONS D AND E DO NOT INCLUDE MOLD FLASH OR PROTRUSIONS AND ARE MEASURED AT THE PARTING LINE. MOLD FLASH OR PROTRUSIONS SHALL NOT EXCEED 0.15 (0.006) PER SIDE.
4. TERMINAL NUMBERS ARE SHOWN FOR REFERENCE ONLY.
5. THE LEAD WIDTH DIMENSION (b) DOES NOT INCLUDE DAMBAR PROTRUSION. ALLOWABLE DAMBAR PROTRUSION SHALL BE 0.08 (0.003) TOTAL IN EXCESS OF THE LEAD WIDTH DIMENSION AT MAXIMUM MATERIAL CONDITION. DAMBAR CANNOT BE LOCATED ON THE LOWER RADIUS OR THE FOOT. MINIMUM SPACE BETWEEN PROTRUSIONS AND ADJACENT LEAD TO BE 0.46 (0.018).

DIM	MILLIMETERS		INCHES	
	MIN	MAX	MIN	MAX
A	---	2.05	---	0.081
A ₁	0.05	0.20	0.002	0.008
b	0.35	0.50	0.014	0.020
c	0.18	0.27	0.007	0.011
D	9.90	10.50	0.390	0.413
E	5.10	5.45	0.201	0.215
e	1.27 BSC		0.050 BSC	
HE	7.40	8.20	0.291	0.323
L	0.50	0.85	0.020	0.033
LE	1.10	1.50	0.043	0.059
M	0°	10°	0°	10°
Q ₁	0.70	0.90	0.028	0.035
Z	---	0.78	---	0.031

ON Semiconductor and **ON** are trademarks of Semiconductor Components Industries, LLC (SCILLC). SCILLC reserves the right to make changes without further notice to any products herein. SCILLC makes no warranty, representation or guarantee regarding the suitability of its products for any particular purpose, nor does SCILLC assume any liability arising out of the application or use of any product or circuit, and specifically disclaims any and all liability, including without limitation special, consequential or incidental damages. "Typical" parameters which may be provided in SCILLC data sheets and/or specifications can and do vary in different applications and actual performance may vary over time. All operating parameters, including "Typicals" must be validated for each customer application by customer's technical experts. SCILLC does not convey any license under its patent rights nor the rights of others. SCILLC products are not designed, intended, or authorized for use as components in systems intended for surgical implant into the body, or other applications intended to support or sustain life, or for any other application in which the failure of the SCILLC product could create a situation where personal injury or death may occur. Should Buyer purchase or use SCILLC products for any such unintended or unauthorized application, Buyer shall indemnify and hold SCILLC and its officers, employees, subsidiaries, affiliates, and distributors harmless against all claims, costs, damages, and expenses, and reasonable attorney fees arising out of, directly or indirectly, any claim of personal injury or death associated with such unintended or unauthorized use, even if such claim alleges that SCILLC was negligent regarding the design or manufacture of the part. SCILLC is an Equal Opportunity/Affirmative Action Employer.

PUBLICATION ORDERING INFORMATION

Literature Fulfillment:

Literature Distribution Center for ON Semiconductor
P.O. Box 5163, Denver, Colorado 80217 USA
Phone: 303-675-2175 or 800-344-3860 Toll Free USA/Canada
Fax: 303-675-2176 or 800-344-3867 Toll Free USA/Canada
Email: ONlit@hibbertco.com

N. American Technical Support: 800-282-9855 Toll Free USA/Canada

JAPAN: ON Semiconductor, Japan Customer Focus Center
4-32-1 Nishi-Gotanda, Shinagawa-ku, Tokyo, Japan 141-0031
Phone: 81-3-5740-2700
Email: r14525@onsemi.com

ON Semiconductor Website: <http://onsemi.com>

For additional information, please contact your local Sales Representative.