

# NB4N316M

## 3.3 V AnyLevel™ Receiver to CML Driver/Translator with Input Hysteresis

### 2.0 GHz Clock / 2.5 Gb/s Data

The NB4N316M is a differential Clock or Data receiver and will accept AnyLevel input signals: LVPECL, CML, LVCMOS, LVTTTL, or LVDS. These signals will be translated to CML, operating up to 2.0 GHz or 2.5 Gb/s, respectively. As such, the NB4N316M is ideal for SONET, GigE, Fiber Channel, Backplane and other Clock or Data distribution applications. The CML outputs are 16 mA open collector (see Figure 18) which requires resistor ( $R_L$ ) load path to  $V_{TT}$  termination voltage (see Figure 19). The open collector CML outputs must be terminated to  $V_{TT}$  at power up. The differential outputs produce Current-Mode Logic (CML) compatible levels when the receiver is loaded with 50  $\Omega$  or 25  $\Omega$  loads connected to 1.8 V, 2.5 V or 3.3 V supplies. This simplifies device interface by eliminating a need for coupling capacitors.

The NB4N316M features an input threshold hysteresis of approximately 25 mV, providing increased noise immunity and stability.

The device is offered in a small 8-pin TSSOP package (MSOP-8 compatible). Application notes, models, and support documentation are available at [www.onsemi.com](http://www.onsemi.com).

#### Features

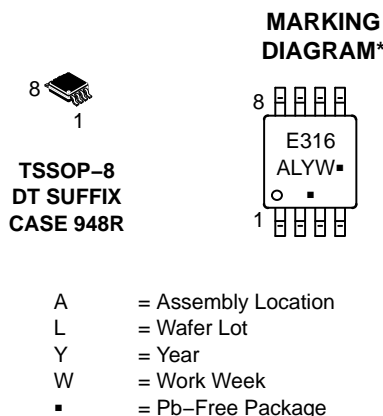
- Maximum Input Clock Frequency > 2.0 GHz
- Maximum Input Data Rate > 2.5 Gb/s
- Typically 1 ps of RMS Clock Jitter
- Typically 10 ps of Data Dependent Jitter
- 550 ps Typical Propagation Delay
- 150 ps Typical Rise and Fall Times
- Differential CML Outputs
- 25 mV of Receiver Input Threshold Hysteresis
- Operating Range:  $V_{CC} = 3.0$  V to 3.6 V with  $V_{EE} = 0$  V and  $V_{TT} = 1.8$  V to 3.6 V
- Functionally Compatible with Existing 2.5 V / 3.3 V LVEL, LVEP, EP, and SG Devices
- -40°C to +85°C Ambient Operating Temperature
- These are Pb-Free Devices\*

\*For additional information on our Pb-Free strategy and soldering details, please download the ON Semiconductor Soldering and Mounting Techniques Reference Manual, SOLDERRM/D.



ON Semiconductor®

[www.onsemi.com](http://www.onsemi.com)



(Note: Microdot may be in either location)

\*For additional marking information, refer to Application Note AND8002/D.

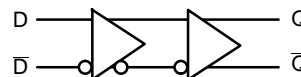
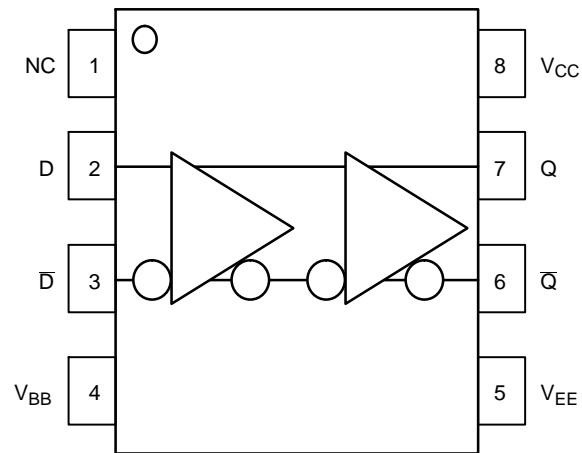


Figure 1. Functional Block Diagram

#### ORDERING INFORMATION

See detailed ordering and shipping information in the package dimensions section on page 11 of this data sheet.

## NB4N316M



**Figure 2. Pinout (Top View) and Logic Diagram**

**Table 1. Pin Description**

Pin	Name	I/O	Description
1	NC	–	No Connect.
2	D	ECL, CML, LVCMOS, LVDS, LVTTTL Input	Noninverted Differential Input. (Note 1)
3	$\bar{D}$	ECL, CML, LVCMOS, LVDS, LVTTTL Input	Inverted Differential Input. (Note 1)
4	V <sub>BB</sub>	–	Internally Generated Reference Voltage Supply.
5	V <sub>EE</sub>	–	Negative Supply Voltage.
6	$\bar{Q}$	CML Output	Inverted Differential Output. Typically Terminated with 50 $\Omega$ Resistor to V <sub>TT</sub> .
7	Q	CML Output	Noninverted Differential Output. Typically Terminated with 50 $\Omega$ Resistor to V <sub>TT</sub> .
8	V <sub>CC</sub>	–	Positive Supply Voltage.

1. In the differential configuration if no signal is applied on D/ $\bar{D}$  input, then the device will be susceptible to self-oscillation.

# NB4N316M

**Table 2. ATTRIBUTES**

Characteristics		Value
ESD Protection	Human Body Model Machine Model	> 1000 V > 70 V
Moisture Sensitivity (Note 1)	8-TSSOP	Level 3
Flammability Rating	Oxygen Index: 28 to 34	UL 94 V-0 @ 0.125 in
Transistor Count		225
Meets or exceeds JEDEC Spec EIA/JESD78 IC Latchup Test		

1. For additional information, see Application Note AND8003/D.

**Table 3. MAXIMUM RATINGS**

Symbol	Parameter	Condition 1	Condition 2	Rating	Unit
V <sub>CC</sub>	Positive Power Supply	V <sub>EE</sub> = -0.5 V		4	V
V <sub>EE</sub>	Negative Power Supply	V <sub>CC</sub> = +0.5 V		-4	V
V <sub>I</sub>	Positive Input Negative Input	V <sub>EE</sub> = 0 V V <sub>CC</sub> = 0 V	V <sub>I</sub> = V <sub>CC</sub> + 0.4 V V <sub>I</sub> = V <sub>EE</sub> - 0.4 V	4 -4	V V
V <sub>O</sub>	Output Voltage Minimum Maximum			V <sub>EE</sub> + 600 V <sub>CC</sub> + 400	mV mV
T <sub>A</sub>	Operating Temperature Range			-40 to +85	°C
T <sub>stg</sub>	Storage Temperature Range			-65 to +150	°C
θ <sub>JA</sub>	Thermal Resistance (Junction-to-Ambient) (Note 2)	0 lfpm 500 lfpm	TSSOP-8 TSSOP-8	190 130	°C/W °C/W
θ <sub>JC</sub>	Thermal Resistance (Junction-to-Case)	1S2P (Note 2)	TSSOP-8	41 to 44	°C/W
T <sub>sol</sub>	Wave Solder	< 3 Sec @ 260°C		265	°C

Stresses exceeding those listed in the Maximum Ratings table may damage the device. If any of these limits are exceeded, device functionality should not be assumed, damage may occur and reliability may be affected.

2. JEDEC standard multilayer board – 1S2P (1 signal, 2 power) with 8 filled thermal vias under exposed pad.

# NB4N316M

**Table 4. DC CHARACTERISTICS, CLOCK Inputs, CML Outputs**  $V_{CC} = 3.0\text{ V to }3.6\text{ V}$ ,  $V_{EE} = 0\text{ V}$ ,  $T_A = -40^\circ\text{C to }+85^\circ\text{C}$

Symbol	Characteristic	Min	Typ	Max	Unit
$I_{CC}$	Power Supply Current (Inputs and Outputs Open)		20	30	mA

$R_L = 50\ \Omega$ ,  $V_{TT} = 3.6\text{ V to }2.5\text{ V}$

$V_{OH}$	Output HIGH Voltage (Note 3)	$V_{TT} - 60$	$V_{TT} - 10$	$V_{TT}$	mV
$V_{OL}$	Output LOW Voltage (Note 3)	$V_{TT} - 1100$	$V_{TT} - 800$	$V_{TT} - 640$	mV
$ V_{OD} $	Differential Output Voltage Magnitude	640	780	1000	mV

$R_L = 25\ \Omega$ ,  $V_{TT} = 3.6\text{ V to }2.5\text{ V} \pm 5\%$

$V_{OH}$	Output HIGH Voltage (Note 3)	$V_{TT} - 60$	$V_{TT} - 10$	$V_{TT}$	mV
$V_{OL}$	Output LOW Voltage (Note 3)	$V_{TT} - 550$	$V_{TT} - 400$	$V_{TT} - 320$	mV
$ V_{OD} $	Differential Output Voltage Magnitude	320	390	500	mV

$R_L = 50\ \Omega$ ,  $V_{TT} = 1.8\text{ V} \pm 5\%$

$V_{OH}$	Output HIGH Voltage (Note 3)	$V_{TT} - 170$	$V_{TT} - 10$	$V_{TT}$	mV
$V_{OL}$	Output LOW Voltage (Note 3)	$V_{TT} - 1100$	$V_{TT} - 800$	$V_{TT} - 640$	mV
$ V_{OD} $	Differential Output Voltage Magnitude	570	780	1000	mV

$R_L = 25\ \Omega$ ,  $V_{TT} = 1.8\text{ V} \pm 5\%$

$V_{OH}$	Output HIGH Voltage (Note 3)	$V_{TT} - 85$	$V_{TT} - 10$	$V_{TT}$	mV
$V_{OL}$	Output LOW Voltage (Note 3)	$V_{TT} - 500$	$V_{TT} - 400$	$V_{TT} - 320$	mV
$ V_{OD} $	Differential Output Voltage Magnitude	285	390	500	mV

#### DIFFERENTIAL INPUT DRIVEN SINGLE-ENDED (Figures 14 and 16)

$V_{th}$	Input Threshold Reference Voltage Range (Note 5)	$V_{EE}$		$V_{CC}$	mV
$V_{IH}$	Single-ended Input HIGH Voltage	$V_{th} + 100$		$V_{CC} + 400$	mV
$V_{IL}$	Single-ended Input LOW Voltage	$V_{EE} - 400$		$V_{th} - 100$	mV
$V_{BB}$	Internally Generated Reference Voltage Supply (Loaded with $-100\ \mu\text{A}$ )	$V_{CC} - 1500$	$V_{CC} - 1400$	$V_{CC} - 1300$	mV

#### DIFFERENTIAL INPUTS DRIVEN DIFFERENTIALLY (Figures 15 and 17)

$V_{IHD}$	Differential Input HIGH Voltage	$V_{EE}$		$V_{CC} + 400$	mV
$V_{ILD}$	Differential Input LOW Voltage	$V_{EE} - 400$		$V_{CC} - 100$	mV
$V_{CMR}$	Input Common Mode Range (Differential Configuration)	$V_{EE}$		$V_{CC}$	mV
$V_{ID(HYST)}$	Differential Input Voltage Hysteresis ( $V_{IHD} - V_{ILD}$ )		25		mV
$ V_{ID} $	Differential Input Voltage Magnitude ( $ V_{IHD} - V_{ILD} $ ) (Note 7)	100		$V_{CC} - V_{EE}$	mV
$C_{IN}$	Input Capacitance (Note 7)		1.5		pF

NOTE: Device will meet the specifications after thermal equilibrium has been established when mounted in a test socket or printed circuit board with maintained transverse airflow greater than 500 lfm.

- CML outputs require  $R_L$  receiver termination resistors to  $V_{TT}$  for proper operation. Outputs must be connected through  $R_L$  to  $V_{TT}$  at power up. The output parameters vary 1:1 with  $V_{TT}$ .  $V_{TT} = 1.71\text{ V to }3.6\text{ V}$ .
- Input parameters vary 1:1 with  $V_{CC}$ .
- $V_{th}$  is applied to the complementary input when operating in single-ended mode.
- $V_{CMR}$  (MIN) varies 1:1 with  $V_{EE}$ .  $V_{CMR}$  max varies 1:1 with  $V_{CC}$ .
- Parameter guaranteed by design and evaluation but not tested in production.

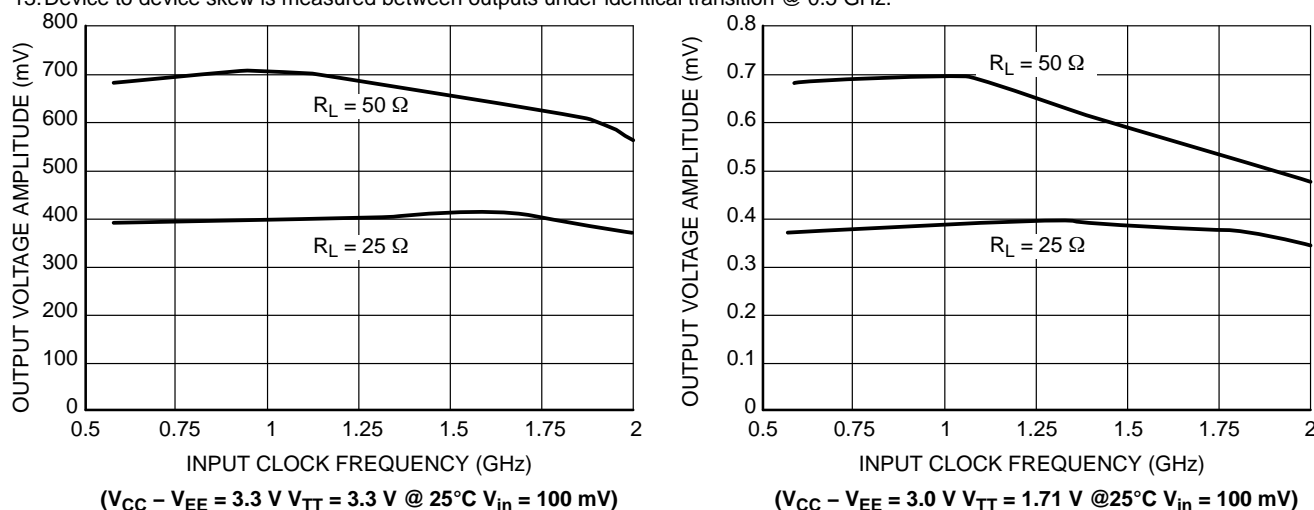
# NB4N316M

**Table 5. AC CHARACTERISTICS**  $V_{CC} = 3.0\text{ V to }3.6\text{ V}$ ,  $V_{EE} = 0\text{ V}$ ; (Note 8)

Symbol	Characteristic	-40°C			25°C			85°C			Unit
		Min	Typ	Max	Min	Typ	Max	Min	Typ	Max	
$V_{OUTPP}$	Output Voltage Amplitude ( $R_L = 50\ \Omega$ ) (See Figure 12) $f_{in} \leq 1\text{ GHz}$ $f_{in} \leq 1.5\text{ GHz}$ $f_{in} \leq 2.0\text{ GHz}$	550 400 200	660 640 400		550 400 200	660 640 400		550 400 200	660 640 400		mV
$V_{OUTPP}$	Output Voltage Amplitude ( $R_L = 25\ \Omega$ ) (See Figure 12) $f_{in} \leq 1\text{ GHz}$ $f_{in} \leq 1.5\text{ GHz}$ $f_{in} \leq 2.0\text{ GHz}$	280 280 200	370 360 300		280 280 200	370 360 400		280 280 200	370 360 400		mV
$f_{DATA}$	Maximum Operating Data Rate	1.5	2.5		1.5	2.5		1.5	2.5		Gb/s
$t_{PLH}$ , $t_{PHL}$	Propagation Delay to Output Differential @ 0.25 GHz	350	550	750	350	550	750	350	550	750	ps
$t_{SKEW}$	Duty Cycle Skew (Note 9) Device to Device Skew (Note 13)		2 20	20 100		2 20	20 100		2 20	20 100	ps
$t_{JITTER}$	RMS Random Clock Jitter $R_L = 50\ \Omega$ and $R_L = 25\ \Omega$ (Note 11) $f_{in} = 750\text{ MHz}$ $f_{in} = 1.5\text{ GHz}$ $f_{in} = 2.0\text{ GHz}$ Peak-to-Peak Data Dependent Jitter $R_L = 50\ \Omega$ (Note 12) $f_{DATA} = 1.5\text{ Gb/s}$ $f_{DATA} = 2.5\text{ Gb/s}$ Peak-to-Peak Data Dependent Jitter $R_L = 25\ \Omega$ (Note 12) $f_{DATA} = 1.5\text{ Gb/s}$ $f_{DATA} = 2.5\text{ Gb/s}$		1 1 1	3 3 3		1 1 1	3 3 3		1 1 1	3 3 3	ps
$V_{INPP}$	Input Voltage Swing/Sensitivity (Differential Configuration) (Note 10)	200			200			200			mV
$t_r$ , $t_f$	Output Rise/Fall Times @ 0.25 GHz (20% – 80%)		150	300		150	300		150	300	ps

NOTE: Device will meet the specifications after thermal equilibrium has been established when mounted in a test socket or printed circuit board with maintained transverse airflow greater than 500 lfm.

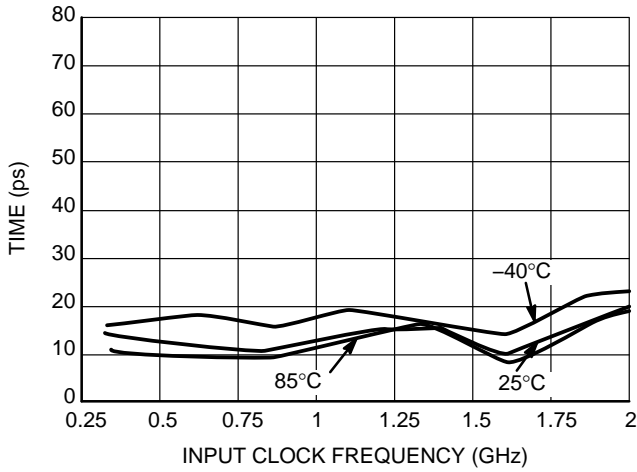
8. Measured by forcing  $V_{INPP}$  (MIN) from a 50% duty cycle clock source. All output loaded with an external  $R_L = 50\ \Omega$  and  $R_L = 25\ \Omega$  to  $V_{TT}$ . Outputs must be connected through  $R_L$  to  $V_{TT}$  at power up. Input edge rates 150 ps (20% – 80%).
9. Duty cycle skew is measured between differential outputs using the deviations of the sum of  $T_{pw-}$  and  $T_{pw+}$  @ 0.25 GHz.
10.  $V_{INPP}$  (MAX) cannot exceed  $V_{CC} - V_{EE}$ . Input voltage swing is a single-ended measurement operating in differential mode.
11. Additive RMS jitter with 50% duty cycle clock signal.
12. Additive peak-to-peak data dependent jitter with input NRZ data signal (PRBS  $2^{23}-1$ ).
13. Device to device skew is measured between outputs under identical transition @ 0.5 GHz.



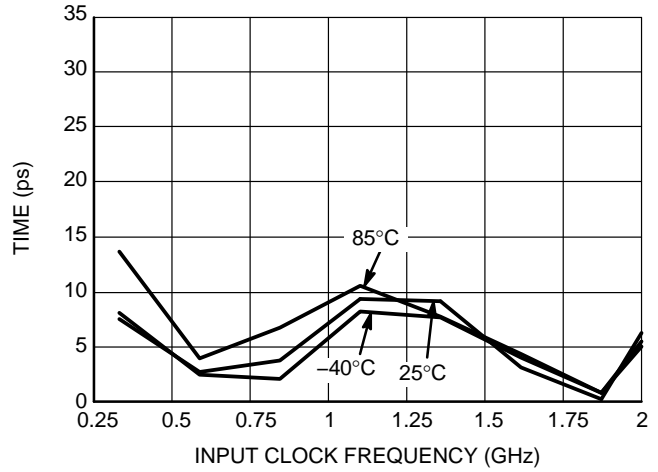
**Figure 3. Output Voltage Amplitude ( $V_{OUTPP}$ ) versus Input Clock Frequency ( $f_{IN}$ ) at Ambient Temperature (Typical)**

# NB4N316M

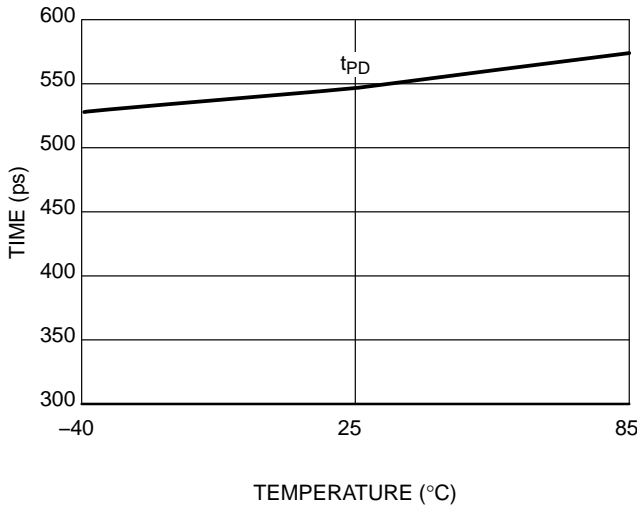
## NB4N316M



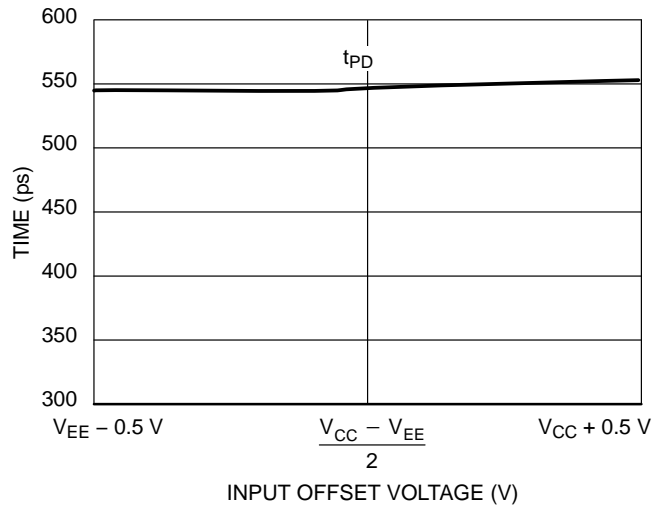
**Figure 4. Data Dependent Jitter vs. Frequency and Temperature ( $V_{CC} - V_{EE} = 3.3\text{ V}$ ;  $V_{TT} = 3.3\text{ V}$  @  $25^\circ\text{C}$ ;  $V_{IN} = 100\text{ mV}$ ; PRBS  $2^{23}-1$ ;  $R_L = 50\ \Omega$ )**



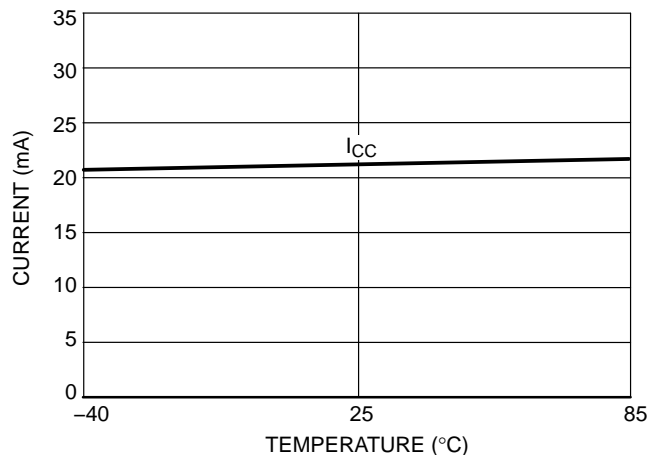
**Figure 5. Data Dependent Jitter vs. Frequency and Temperature ( $V_{CC} - V_{EE} = 3.3\text{ V}$ ;  $V_{TT} = 3.3\text{ V}$  @  $25^\circ\text{C}$ ;  $V_{IN} = 100\text{ mV}$ ; PRBS  $2^{23}-1$ ;  $R_L = 25\ \Omega$ )**



**Figure 6. Typical Propagation Delay vs. Temperature ( $V_{CC} - V_{EE} = 3.3\text{ V}$ ;  $V_{TT} = 3.3\text{ V}$  @  $25^\circ\text{C}$ ;  $V_{in} = 100\text{ mV}$ ;  $R_L = 50\ \Omega$ )**

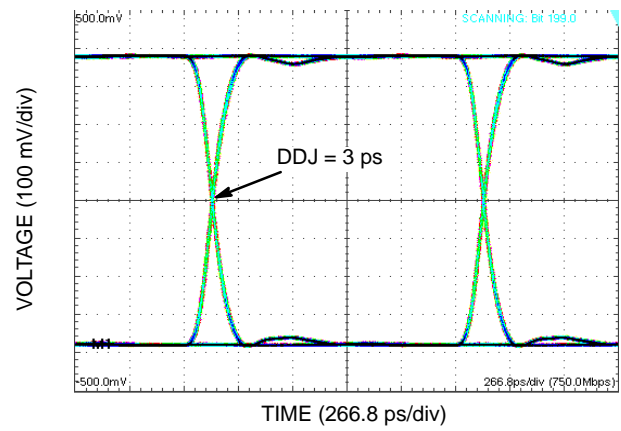
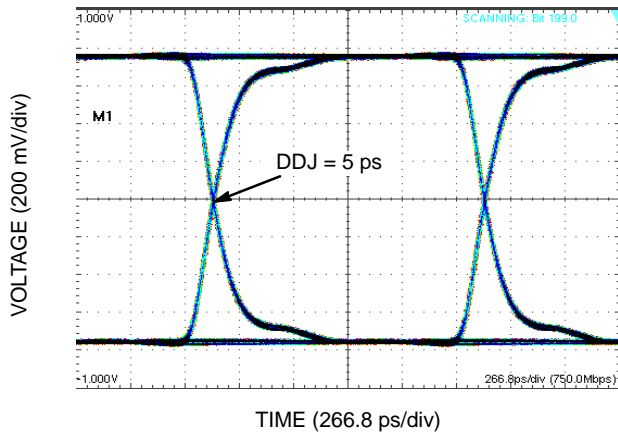


**Figure 7. Typical Propagation Delay vs. Input Offset Voltage ( $V_{CC} - V_{EE} = 3.3\text{ V}$ ;  $V_{TT} = 3.3\text{ V}$  @  $25^\circ\text{C}$ ;  $V_{in} = 100\text{ mV}$ ;  $R_L = 50\ \Omega$ )**

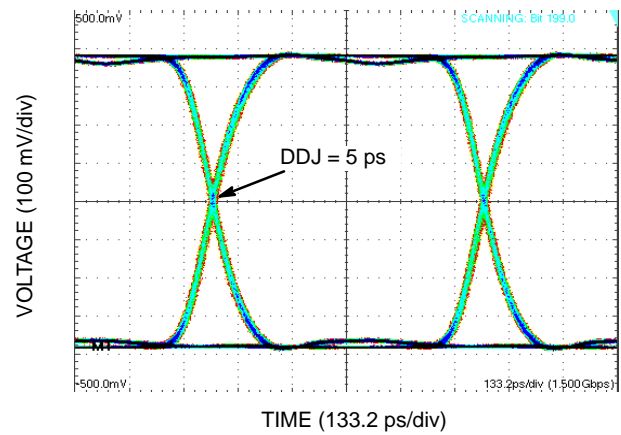
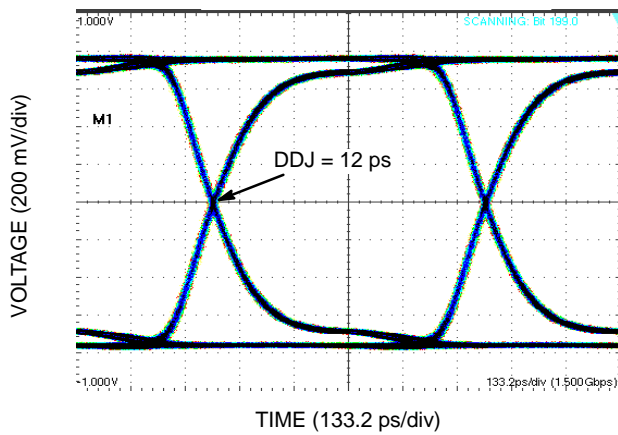


**Figure 8. Supply Current vs. Temperature**

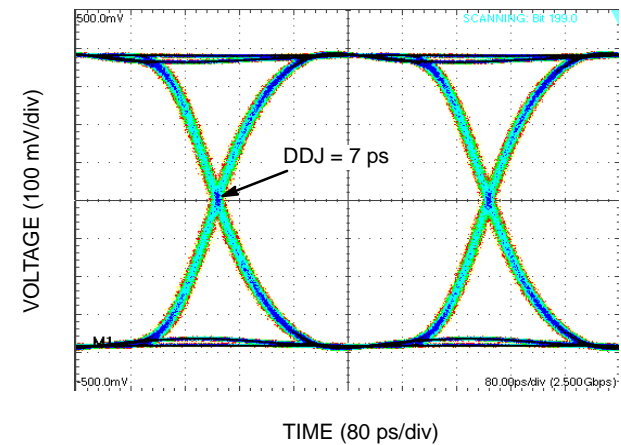
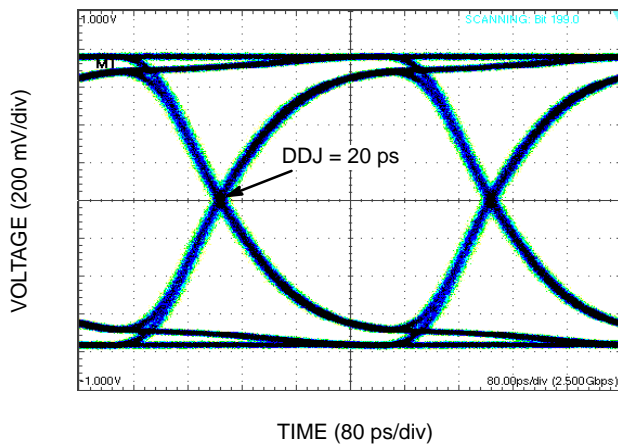
# NB4N316M



**Figure 9. Typical Differential Output Waveform at 750 Mb/s**  
( $R_L = 50 \Omega$  Left Plot,  $R_L = 25 \Omega$  Right Plot,  $V_{in} = 100 \text{ mV}$ , System DDJ = 24 ps)



**Figure 10. Typical Differential Output Waveform 1.5 Gb/s**  
( $R_L = 50 \Omega$  Left Plot,  $R_L = 25 \Omega$  Right Plot,  $V_{in} = 100 \text{ mV}$ , System DDJ = 25 ps)



**Figure 11. Typical Differential Output Waveform 2.5 Gb/s**  
( $R_L = 50 \Omega$  Left Plot,  $R_L = 25 \Omega$  Right Plot,  $V_{in} = 100 \text{ mV}$ , System DDJ = 24 ps)

# NB4N316M

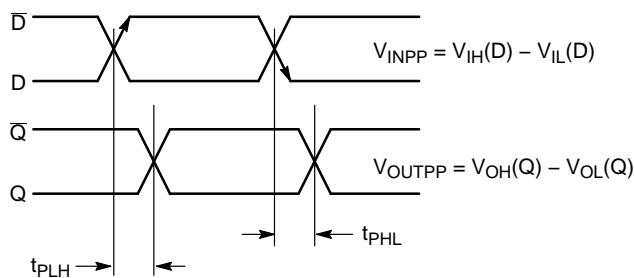


Figure 12. AC Reference Measurement

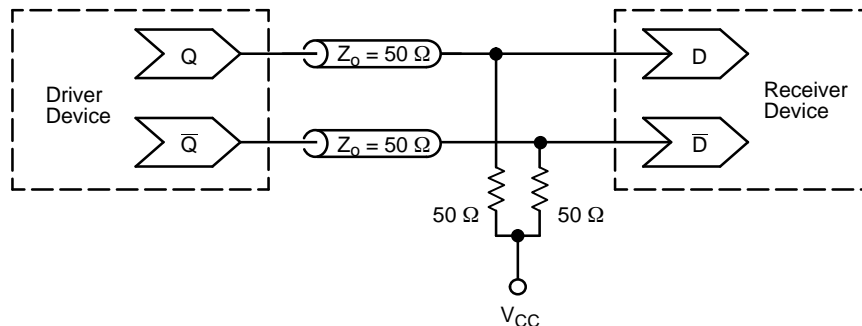


Figure 13. Typical Termination for Output Driver and Device Evaluation (See Application Note AND8020/D – Termination of ECL Logic Devices.)

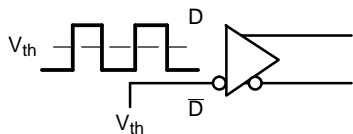


Figure 14. Differential Input Driven Single-Ended

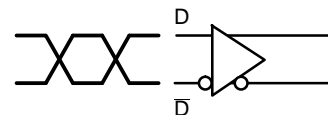


Figure 15. Differential Inputs Driven Differentially

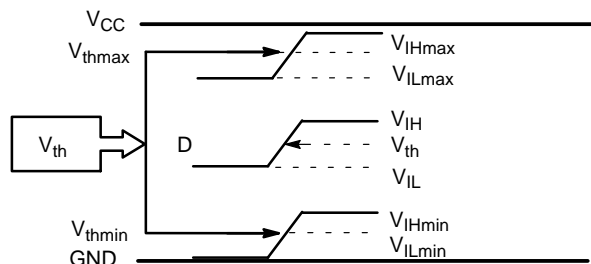


Figure 16.  $V_{th}$  Diagram

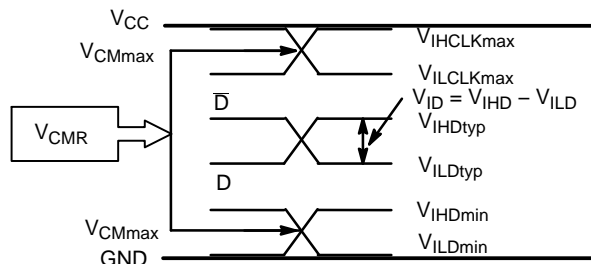


Figure 17.  $V_{CMR}$  Diagram



# NB4N316M

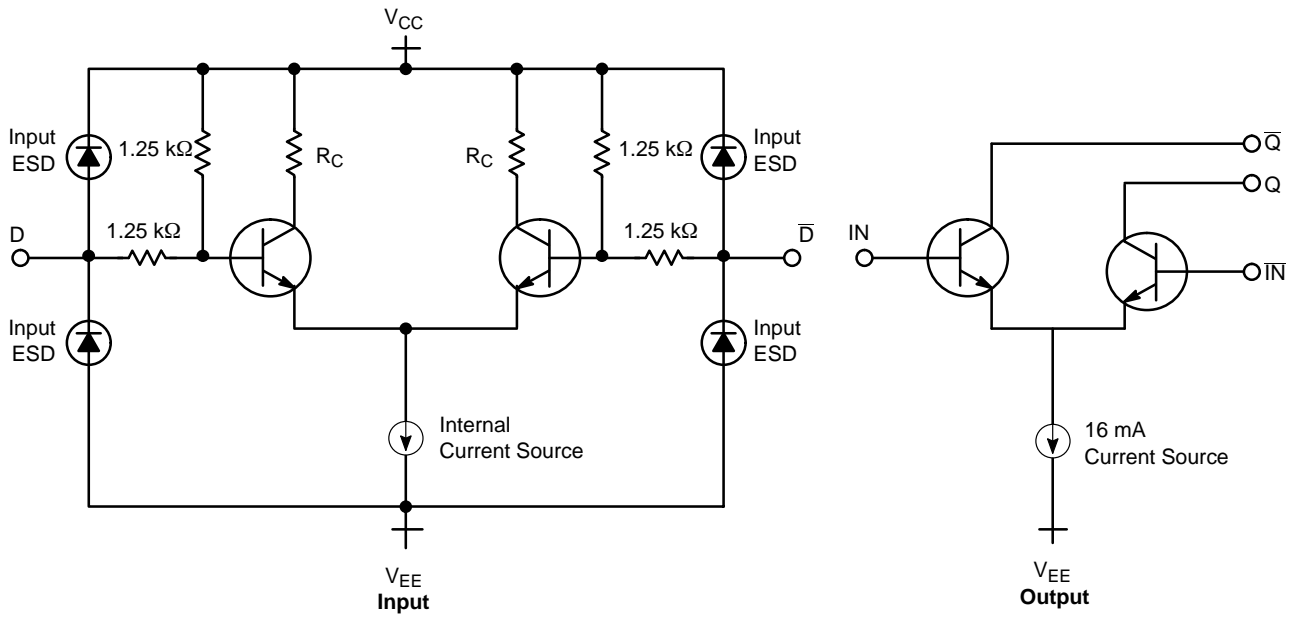


Figure 18. CML Input and Output Structure

# NB4N316M

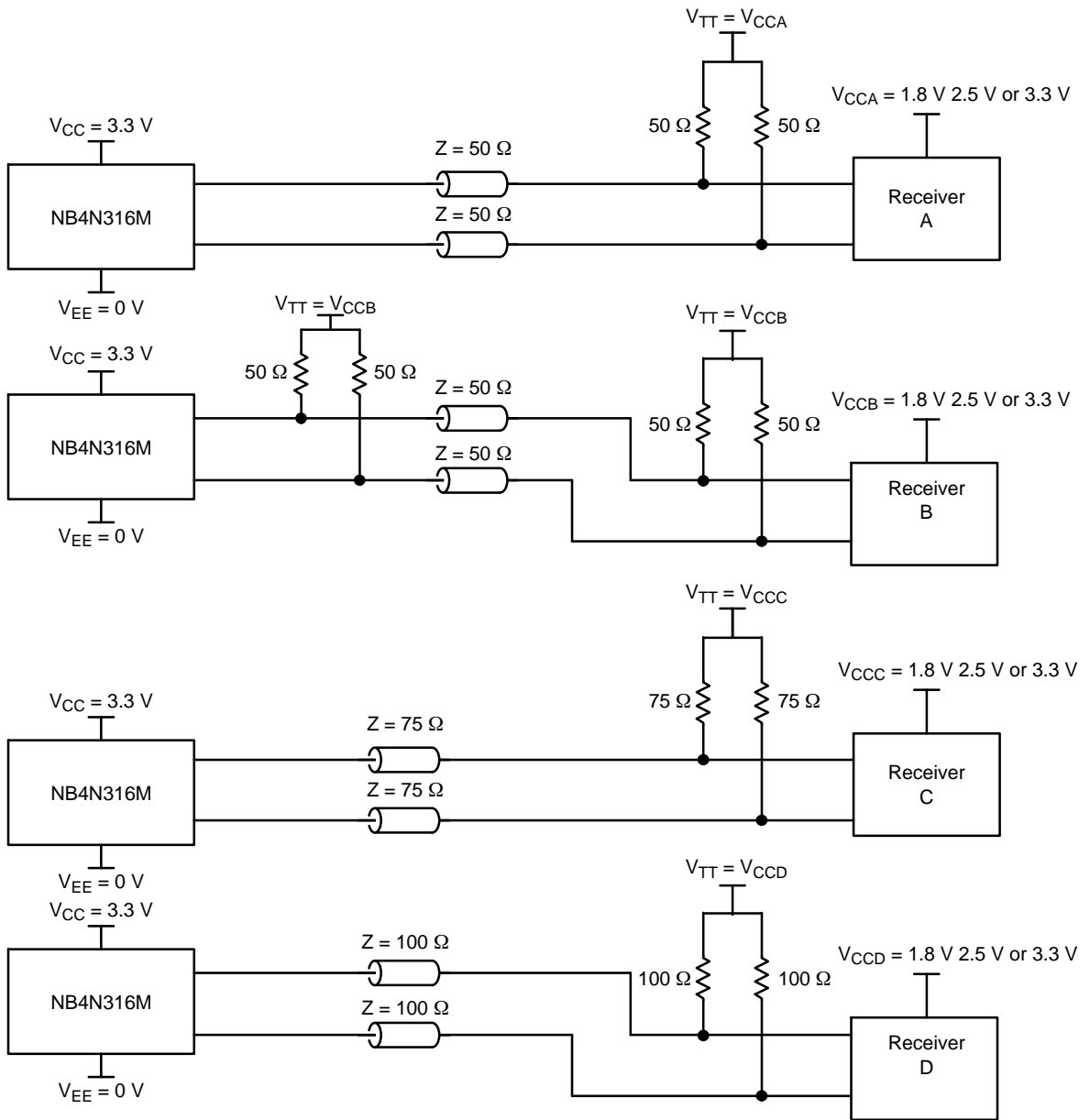


Figure 19. Typical Examples of the Application Interface

# NB4N316M

## ORDERING INFORMATION

Device	Package	Shipping†
NB4N316MDTG	TSSOP-8 (Pb-Free)	100 Units / Rail
NB4N316MDTR2G	TSSOP-8 (Pb-Free)	2500 / Tape & Reel

†For information on tape and reel specifications, including part orientation and tape sizes, please refer to our Tape and Reel Packaging Specifications Brochure, BRD8011/D.

### Resource Reference of Application Notes

- AN1405/D** – ECL Clock Distribution Techniques
- AN1406/D** – Designing with PECL (ECL at +5.0 V)
- AN1503/D** – ECLinPS™ I/O SPiCE Modeling Kit
- AN1504/D** – Metastability and the ECLinPS Family
- AN1568/D** – Interfacing Between LVDS and ECL
- AN1672/D** – The ECL Translator Guide
- AND8001/D** – Odd Number Counters Design
- AND8002/D** – Marking and Date Codes
- AND8020/D** – Termination of ECL Logic Devices
- AND8066/D** – Interfacing with ECLinPS
- AND8090/D** – AC Characteristics of ECL Devices

# MECHANICAL CASE OUTLINE

## PACKAGE DIMENSIONS

ON Semiconductor®



SCALE 2:1

### TSSOP 8 CASE 948R-02 ISSUE A

DATE 04/07/2000



NOTES:

1. DIMENSIONING AND TOLERANCING PER ANSI Y14.5M, 1982.
2. CONTROLLING DIMENSION: MILLIMETER.
3. DIMENSION A DOES NOT INCLUDE MOLD FLASH. PROTRUSIONS OR GATE BURRS. MOLD FLASH OR GATE BURRS SHALL NOT EXCEED 0.15 (0.006) PER SIDE.
4. DIMENSION B DOES NOT INCLUDE INTERLEAD FLASH OR PROTRUSION. INTERLEAD FLASH OR PROTRUSION SHALL NOT EXCEED 0.25 (0.010) PER SIDE.
5. TERMINAL NUMBERS ARE SHOWN FOR REFERENCE ONLY.
6. DIMENSION A AND B ARE TO BE DETERMINED AT DATUM PLANE -V-.

DIM	MILLIMETERS		INCHES	
	MIN	MAX	MIN	MAX
A	2.90	3.10	0.114	0.122
B	2.90	3.10	0.114	0.122
C	0.80	1.10	0.031	0.043
D	0.05	0.15	0.002	0.006
F	0.40	0.70	0.016	0.028
G	0.65 BSC		0.026 BSC	
K	0.25	0.40	0.010	0.016
L	4.90 BSC		0.193 BSC	
M	0°	6°	0°	6°

<b>DOCUMENT NUMBER:</b>	<b>98AON00236D</b>	Electronic versions are uncontrolled except when accessed directly from the Document Repository. Printed versions are uncontrolled except when stamped "CONTROLLED COPY" in red.
<b>DESCRIPTION:</b>	<b>TSSOP 8</b>	<b>PAGE 1 OF 1</b>

ON Semiconductor and are trademarks of Semiconductor Components Industries, LLC dba ON Semiconductor or its subsidiaries in the United States and/or other countries. ON Semiconductor reserves the right to make changes without further notice to any products herein. ON Semiconductor makes no warranty, representation or guarantee regarding the suitability of its products for any particular purpose, nor does ON Semiconductor assume any liability arising out of the application or use of any product or circuit, and specifically disclaims any and all liability, including without limitation special, consequential or incidental damages. ON Semiconductor does not convey any license under its patent rights nor the rights of others.

**onsemi**, **Onsemi**, and other names, marks, and brands are registered and/or common law trademarks of Semiconductor Components Industries, LLC dba "**onsemi**" or its affiliates and/or subsidiaries in the United States and/or other countries. **onsemi** owns the rights to a number of patents, trademarks, copyrights, trade secrets, and other intellectual property. A listing of **onsemi**'s product/patent coverage may be accessed at [www.onsemi.com/site/pdf/Patent-Marking.pdf](http://www.onsemi.com/site/pdf/Patent-Marking.pdf). **onsemi** reserves the right to make changes at any time to any products or information herein, without notice. The information herein is provided "as-is" and **onsemi** makes no warranty, representation or guarantee regarding the accuracy of the information, product features, availability, functionality, or suitability of its products for any particular purpose, nor does **onsemi** assume any liability arising out of the application or use of any product or circuit, and specifically disclaims any and all liability, including without limitation special, consequential or incidental damages. Buyer is responsible for its products and applications using **onsemi** products, including compliance with all laws, regulations and safety requirements or standards, regardless of any support or applications information provided by **onsemi**. "Typical" parameters which may be provided in **onsemi** data sheets and/or specifications can and do vary in different applications and actual performance may vary over time. All operating parameters, including "Typicals" must be validated for each customer application by customer's technical experts. **onsemi** does not convey any license under any of its intellectual property rights nor the rights of others. **onsemi** products are not designed, intended, or authorized for use as a critical component in life support systems or any FDA Class 3 medical devices or medical devices with a same or similar classification in a foreign jurisdiction or any devices intended for implantation in the human body. Should Buyer purchase or use **onsemi** products for any such unintended or unauthorized application, Buyer shall indemnify and hold **onsemi** and its officers, employees, subsidiaries, affiliates, and distributors harmless against all claims, costs, damages, and expenses, and reasonable attorney fees arising out of, directly or indirectly, any claim of personal injury or death associated with such unintended or unauthorized use, even if such claim alleges that **onsemi** was negligent regarding the design or manufacture of the part. **onsemi** is an Equal Opportunity/Affirmative Action Employer. This literature is subject to all applicable copyright laws and is not for resale in any manner.

## PUBLICATION ORDERING INFORMATION

### LITERATURE FULFILLMENT:

Email Requests to: [orderlit@onsemi.com](mailto:orderlit@onsemi.com)

**onsemi Website:** [www.onsemi.com](http://www.onsemi.com)

### TECHNICAL SUPPORT

**North American Technical Support:**

Voice Mail: 1 800-282-9855 Toll Free USA/Canada

Phone: 011 421 33 790 2910

**Europe, Middle East and Africa Technical Support:**

Phone: 00421 33 790 2910

For additional information, please contact your local Sales Representative